

Teilchenphysik mit höchstenergetischen Beschleunigern (Higgs & Co)

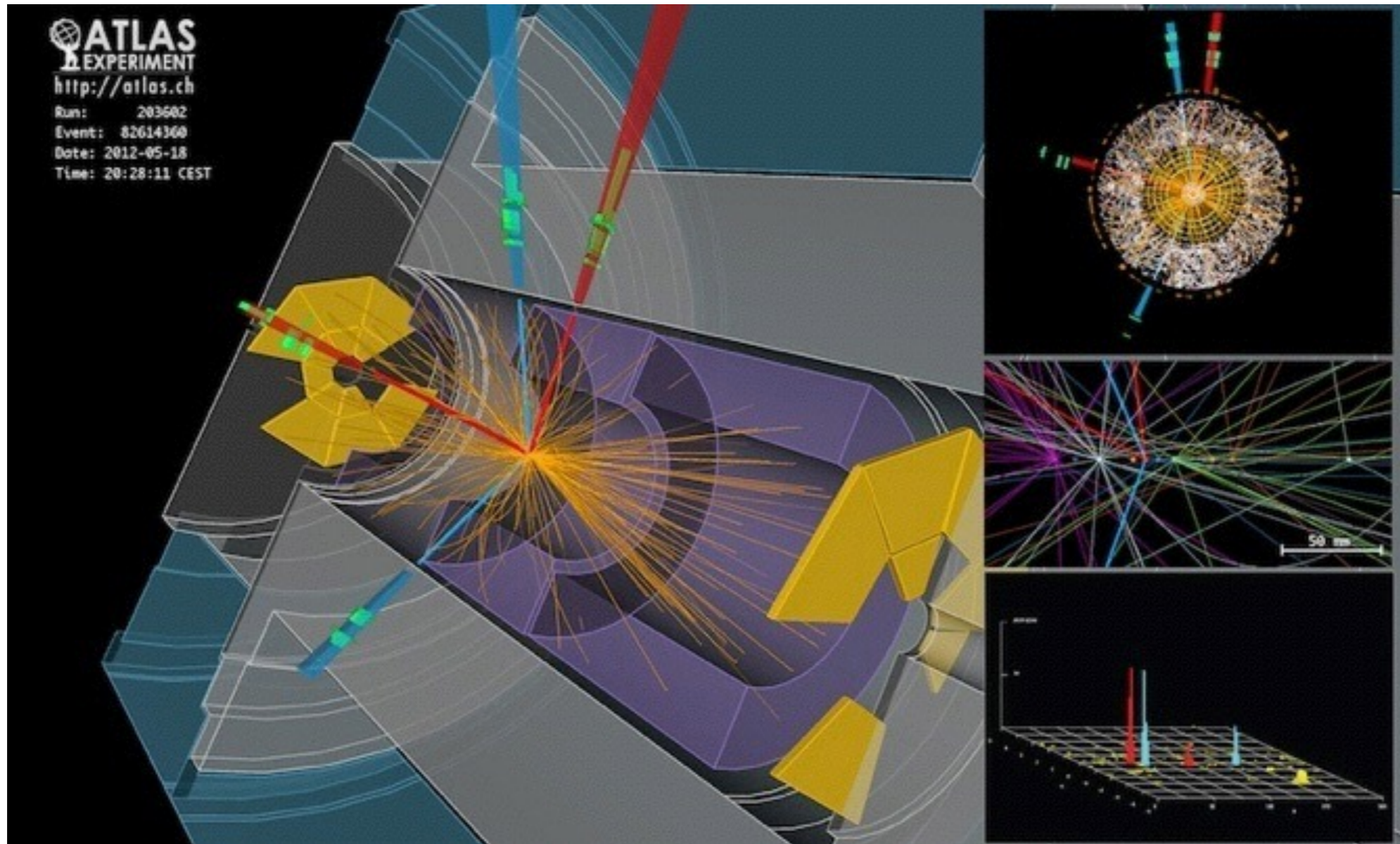

3. Detectors II

26.10.2015



Detectors: Overview

- Lecture Detectors I
 - Introduction, overall detector concepts
 - Detector systems at hadron colliders
 - Basics of particle detection: Interaction with matter
 - Methods for particle detection

- **Lecture Detectors II**
 - Tracking detectors: Basics
 - Semiconductor trackers
 - Calorimeters

Momentum Measurement with Trackers



Tracking: Momentum Measurement in B-Field

- Charged particles are deflected in magnetic field
 - only acts on the component transverse to the field

The radius of the trajectory gives transverse momentum:

$$\frac{p_T}{\text{GeV}/c} = 0.3 \frac{B}{\text{T}} \frac{r}{\text{m}}$$

Tracking: Momentum Measurement in B-Field

- Charged particles are deflected in magnetic field
 - only acts on the component transverse to the field

The radius of the trajectory gives transverse momentum:

$$\frac{p_T}{\text{GeV}/c} = 0.3 \frac{B}{\text{T}} \frac{r}{\text{m}}$$

- parallel to the field there is no deflection
 - ⇒ the particle moves on a helix given by field and p_T

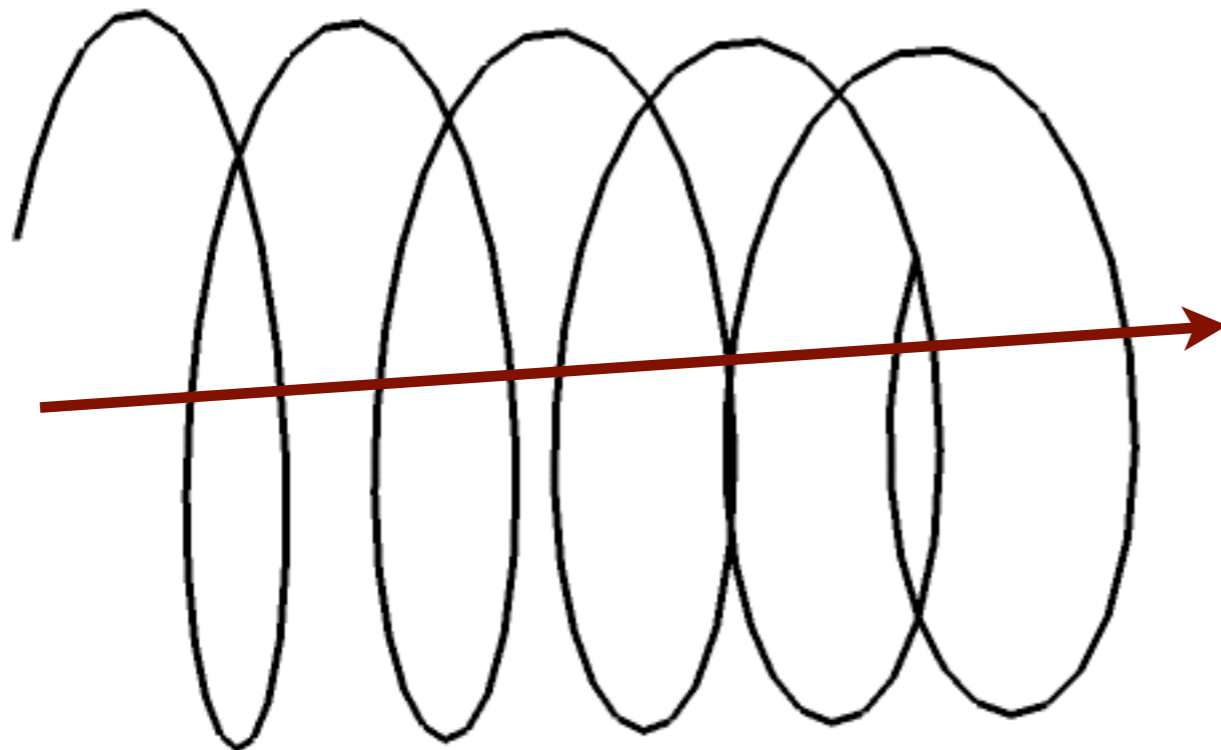

magnetic field

Tracking: Momentum Measurement in B-Field

- Charged particles are deflected in magnetic field
 - only acts on the component transverse to the field

The radius of the trajectory gives transverse momentum:

$$\frac{p_T}{\text{GeV}/c} = 0.3 \frac{B}{\text{T}} \frac{r}{\text{m}}$$

- parallel to the field there is no deflection

⇒ the particle moves on a helix given by field and p_T

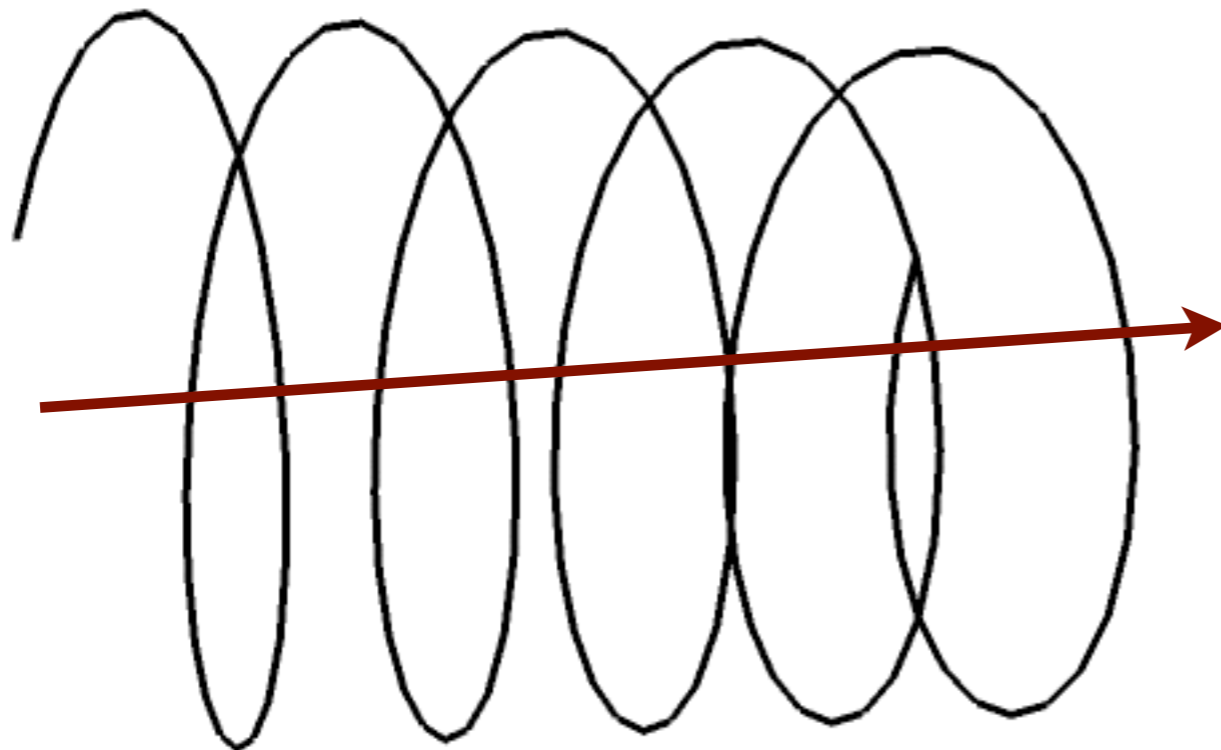

magnetic field

The total momentum is determined with the “dip angle” in addition to p_T :

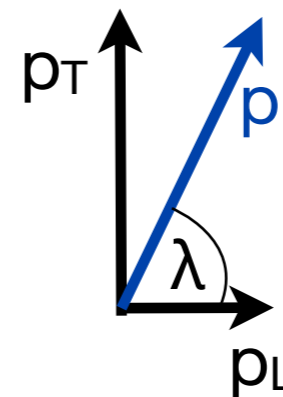

$$p = p_T / \sin \lambda$$

Momentum Measurement in B-Field II

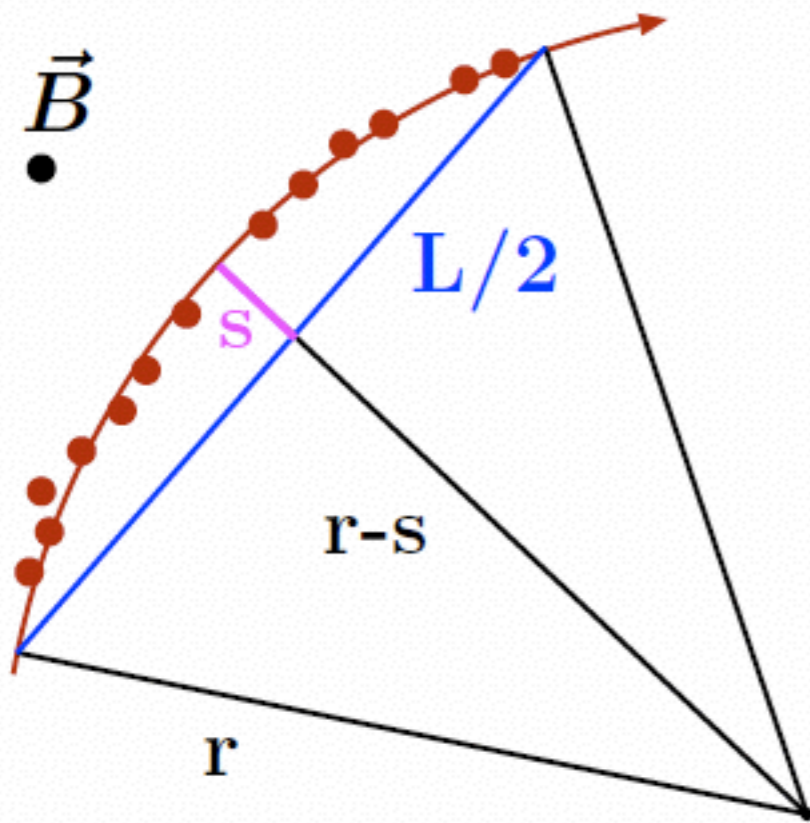

- In real-world applications one does not measure a full circle, but just a slightly bent track segment
- Characteristic variable: **sagitta**

Momentum Measurement in B-Field II

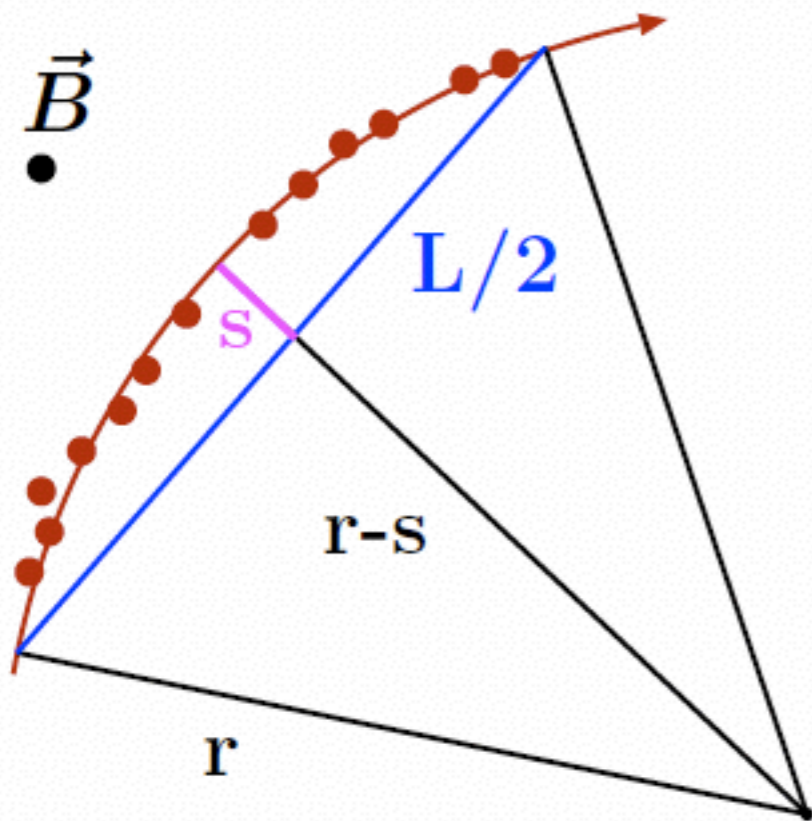

- In real-world applications one does not measure a full circle, but just a slightly bent track segment
- Characteristic variable: **sagitta**

Mathematical calculation:

$$s = r - \sqrt{r^2 - \frac{L^2}{4}}$$

$$\Rightarrow r = \frac{s}{2} + \frac{L^2}{8s} \approx \frac{L^2}{8s} \quad (s \ll L)$$

Momentum Measurement in B-Field II

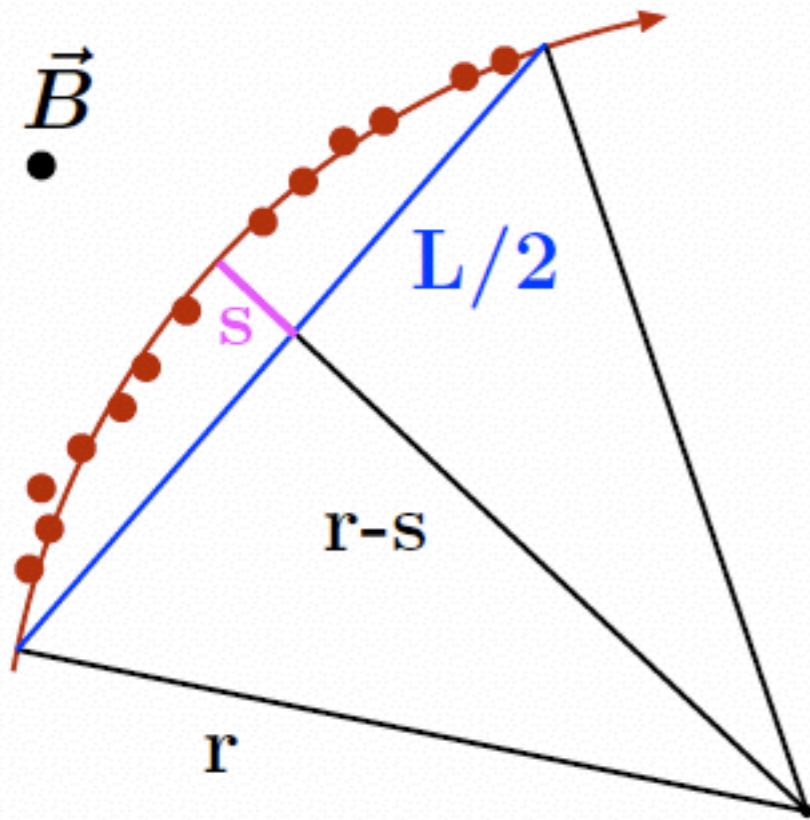

- In real-world applications one does not measure a full circle, but just a slightly bent track segment
- Characteristic variable: **sagitta**

Mathematical calculation:

$$s = r - \sqrt{r^2 - \frac{L^2}{4}}$$

$$\Rightarrow r = \frac{s}{2} + \frac{L^2}{8s} \approx \frac{L^2}{8s} \quad (s \ll L)$$

Taking the relation of radius, momentum and B-field gives:

$$r = \frac{p_T}{0.3 B} \Rightarrow s = \frac{0.3 B L^2}{8 p_T}$$

Momentum Measurement in B-Field III

- A minimum of 3 points are required to determine the sagitta
 - Taking into account the point-by-point measurement uncertainty:

$$\sigma^2(s) = \frac{1}{N-1} \sum_{i=1}^N \sigma^2(x) \quad \text{für } N = 3 \text{ there are 2 degrees of freedom}$$

$\sigma(s)$ sagitta error ; $\sigma(x)$ uncertainty of a single point

Momentum Measurement in B-Field III

- A minimum of 3 points are required to determine the sagitta
- Taking into account the point-by-point measurement uncertainty:

$$\sigma^2(s) = \frac{1}{N-1} \sum_{i=1}^N \sigma^2(x) \quad \text{für } N = 3 \text{ there are 2 degrees of freedom}$$

$\sigma(s)$ sagitta error ; $\sigma(x)$ uncertainty of a single point

$$\text{with } p_T = \frac{0.3 B L^2}{8 s}$$

$$\sigma(s) = \sqrt{\frac{3}{2}} \sigma(x) \Rightarrow \frac{\sigma(p_T)}{p_T} = \frac{\sigma(s)}{s} = \frac{\sqrt{\frac{3}{2}} \sigma(x) 8 p_T}{0.3 B L^2}$$

Momentum Measurement in B-Field III

- A minimum of 3 points are required to determine the sagitta
- Taking into account the point-by-point measurement uncertainty:

$$\sigma^2(s) = \frac{1}{N-1} \sum_{i=1}^N \sigma^2(x) \quad \text{für } N = 3 \text{ there are 2 degrees of freedom}$$

$\sigma(s)$ sagitta error ; $\sigma(x)$ uncertainty of a single point

$$\text{with } p_T = \frac{0.3 B L^2}{8 s}$$

$$\sigma(s) = \sqrt{\frac{3}{2}} \sigma(x) \Rightarrow \frac{\sigma(p_T)}{p_T} = \frac{\sigma(s)}{s} = \frac{\sqrt{\frac{3}{2}} \sigma(x) 8 p_T}{0.3 B L^2}$$

generalization to an arbitrary number of points:

$$\frac{\sigma(p_T)}{p_T} = \frac{\sigma(x)}{0.3 B L^2} \sqrt{720/(N+4)} p_T$$

R.L. Gluckstern,
NIM 24, 381 (1963)

Momentum Measurement in B-Field III

- A minimum of 3 points are required to determine the sagitta
 - Taking into account the point-by-point measurement uncertainty:

$$\sigma^2(s) = \frac{1}{N-1} \sum_{i=1}^N \sigma^2(x) \quad \text{für } N = 3 \text{ there are 2 degrees of freedom}$$

$\sigma(s)$ sagitta error ; $\sigma(x)$ uncertainty of a single point

with $p_T = \frac{0.3 B L^2}{8 s}$

$$\sigma(s) = \sqrt{\frac{3}{2}} \sigma(x) \Rightarrow \frac{\sigma(p_T)}{p_T} = \frac{\sigma(s)}{s} = \frac{\sqrt{\frac{3}{2}} \sigma(x) 8 p_T}{0.3 B L^2}$$

generalization to an arbitrary number of points:

$$\frac{\sigma(p_T)}{p_T} = \frac{\sigma(x)}{0.3 B L^2} \sqrt{720 / (N + 4)} p_T$$

R.L. Gluckstern,
NIM 24, 381 (1963)

- ➡ The bigger B, lever arm L and the number of measurements and the better the spatial resolution, the higher is the accuracy of the momentum measurement
example (ATLAS Si-Tracker): $N = 7$, $L = 0.5$, $B = 2\text{T}$, $\sigma(x) = 20 \mu\text{m}$, $p_t = 5 \text{ GeV}/c$:
 $\Delta p_t / p_t = 0.5 \%$, $r = 8.3 \text{ m}$, $s = 3.75 \text{ mm}$

Conflicting Effect: Multiple Scattering

- Charged particles are deflected when traversing matter:
Multiple scattering via Coulomb interaction

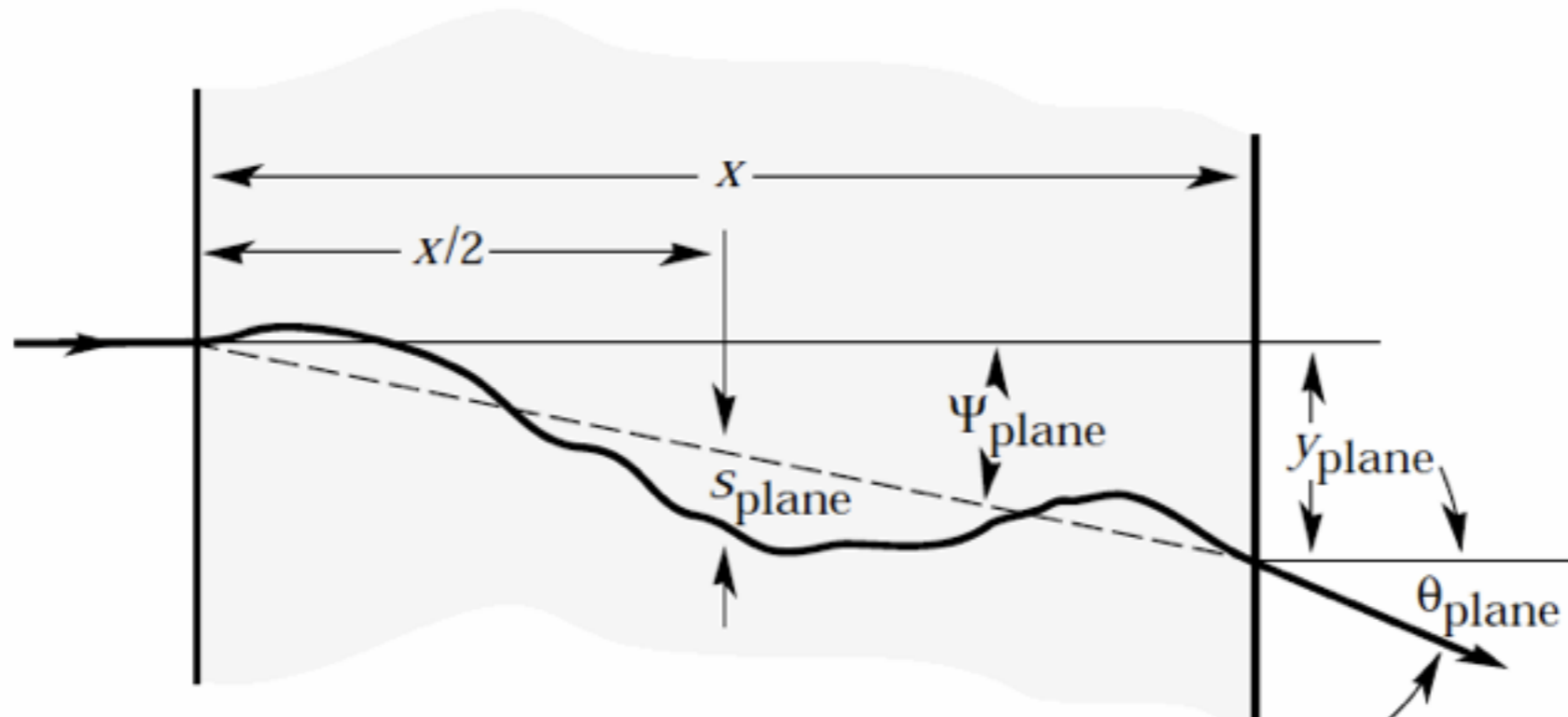

$$\theta_0 = \theta_{\text{plane}}^{\text{rms}} = \frac{1}{\sqrt{2}} \theta_{\text{space}}^{\text{rms}} \quad \theta_0 = \frac{13.6 \text{ MeV}}{\beta c p} z \sqrt{x/X_0} [1 + 0.038 \ln(x/X_0)]$$

- valid for relativistic particles ($\beta = 1$), the central 98% of the distribution, for layer thicknesses from $10^{-3} X_0$ to $100 X_0$ with an accuracy of better than 11%

Impulsauflösung: Ortsauflösung & Vielfachstreuung

- Two effects influence the momentum resolution $\sigma(p_T)/p_T$ of tracking systems:
 - Momentum resolution of the tracker: $\sigma(p_T) \propto p_T$

Impulsauflösung: Ortsauflösung & Vielfachstreuung

- Two effects influence the momentum resolution $\sigma(p_T)/p_T$ of tracking systems:
 - Momentum resolution of the tracker: $\sigma(p_T) \propto p_T$
 - Influence of multiple scattering

$\theta \propto \frac{1}{p}$ and with that also the spatial inaccuracy due to scattering:

$$\sigma(x)_{MS} \propto \frac{1}{p}$$

Impulsauflösung: Ortsauflösung & Vielfachstreuung

- Two effects influence the momentum resolution $\sigma(p_T)/p_T$ of tracking systems:
 - Momentum resolution of the tracker: $\sigma(p_T) \propto p_T$
 - Influence of multiple scattering

$\theta \propto \frac{1}{p}$ and with that also the spatial inaccuracy due to scattering:

$$\sigma(x)_{MS} \propto \frac{1}{p}$$

We know: $\frac{\sigma(p_T)}{p_T} \propto \sigma(x)_{MS} \times p_T$

and with that: $\left. \frac{\sigma(p_T)}{p_T} \right|_{MS} = \text{const}$

Impulsauflösung: Ortsauflösung & Vielfachstreuung

- Two effects influence the momentum resolution $\sigma(p_T)/p_T$ of tracking systems:
 - Momentum resolution of the tracker: $\sigma(p_T) \propto p_T$
 - Influence of multiple scattering

$\theta \propto \frac{1}{p}$ and with that also the spatial inaccuracy due to scattering:

$$\sigma(x)_{MS} \propto \frac{1}{p}$$

We know: $\frac{\sigma(p_T)}{p_T} \propto \sigma(x)_{MS} \times p_T$

and with that: $\left. \frac{\sigma(p_T)}{p_T} \right|_{MS} = \text{const}$

The measurement of low-momentum particles is limited by multiple scattering!
At higher momenta the intrinsic resolution of the detector dominates.

Spatial Resolution of Tracking Detectors

- Depends on detector geometry and charge collection:
 - distance between strips
 - charge sharing between neighboring strips

Spatial Resolution of Tracking Detectors

- Depends on detector geometry and charge collection:
 - distance between strips
 - charge sharing between neighboring strips

Easiest case: The full charge is collected on a single strip:

Spatial Resolution of Tracking Detectors

- Depends on detector geometry and charge collection:
 - distance between strips
 - charge sharing between neighboring strips

Easiest case: The full charge is collected on a single strip:

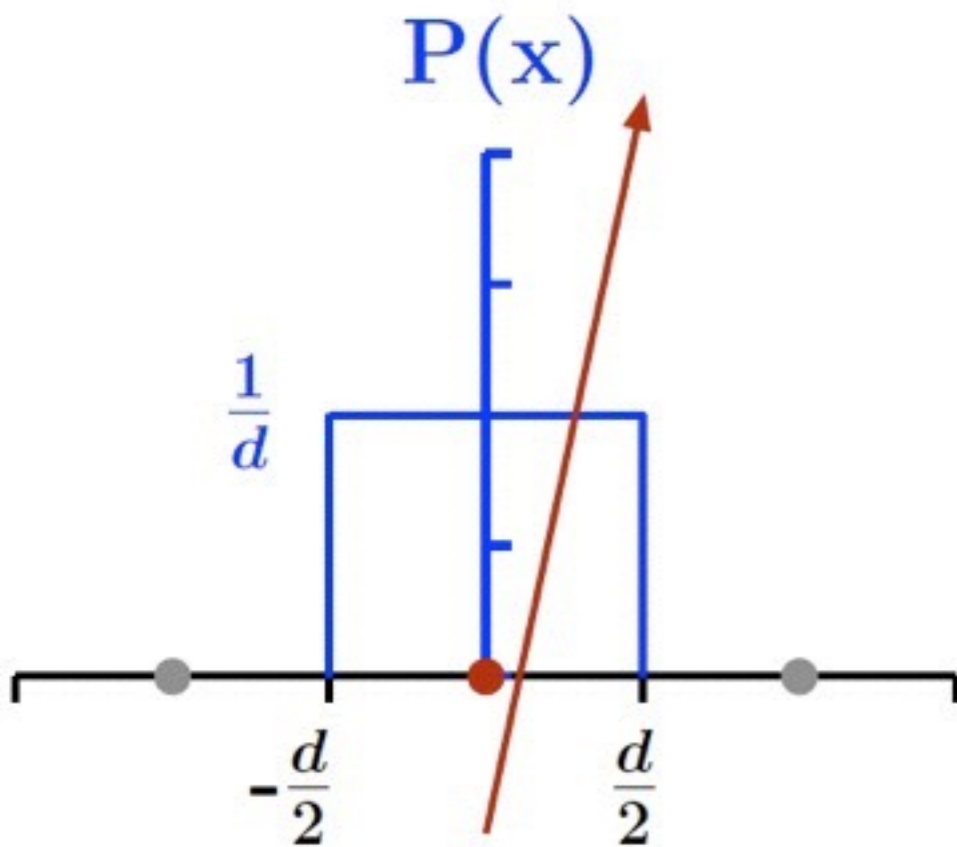

- Particle impact generates a signal in the hit strip
 - The response does not depend on impact point, no point on the strip is “special”
- ▶ Equal probability distribution for particle position:

$$P(x) = \frac{1}{d} \quad \Rightarrow \quad \int_{-d/2}^{d/2} P(x) dx = 1$$

Spatial Resolution of Tracking Detectors

- Depends on detector geometry and charge collection:
 - distance between strips
 - charge sharing between neighboring strips

Easiest case: The full charge is collected on a single strip:

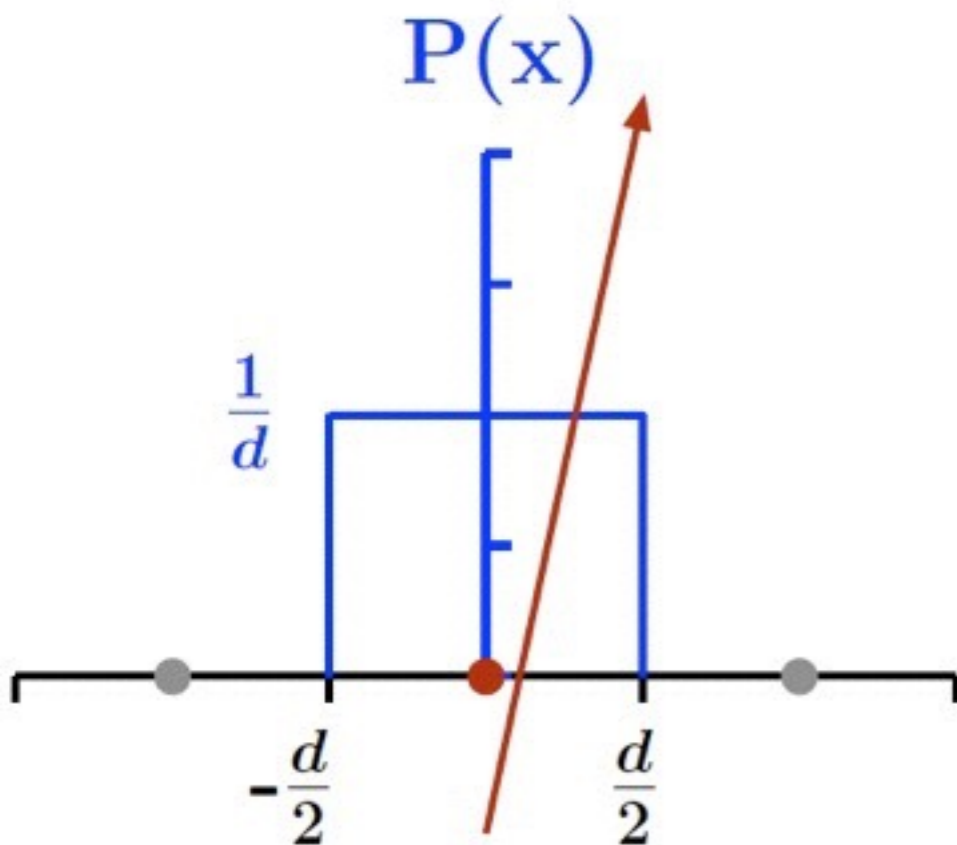

- Particle impact generates a signal in the hit strip
 - The response does not depend on impact point, no point on the strip is “special”
- ▶ Equal probability distribution for particle position:

$$P(x) = \frac{1}{d} \quad \Rightarrow \quad \int_{-d/2}^{d/2} P(x) dx = 1$$

The reconstructed impact position is always the strip center:

$$\langle x \rangle = \int_{-d/2}^{d/2} x P(x) dx = 0$$

Spatial Resolution of Tracking Detectors II

- The spatial resolution orthogonal to the strip direction is thus:

$$\sigma_x^2 = \langle (x - \langle x \rangle)^2 \rangle = \int_{-d/2}^{d/2} x^2 P(x) dx = \frac{d^2}{12}$$

Spatial Resolution of Tracking Detectors II

- The spatial resolution orthogonal to the strip direction is thus:

$$\sigma_x^2 = \langle (x - \langle x \rangle)^2 \rangle = \int_{-d/2}^{d/2} x^2 P(x) dx = \frac{d^2}{12}$$

- General law for tracking detectors (also applies to wire chambers, pixels, ...) without signal sharing across several channels:

$$\sigma = \frac{d}{\sqrt{12}}$$

Spatial Resolution of Tracking Detectors II

- The spatial resolution orthogonal to the strip direction is thus:

$$\sigma_x^2 = \langle (x - \langle x \rangle)^2 \rangle = \int_{-d/2}^{d/2} x^2 P(x) dx = \frac{d^2}{12}$$

- General law for tracking detectors (also applies to wire chambers, pixels, ...) without signal sharing across several channels:

$$\sigma = \frac{d}{\sqrt{12}}$$

- For silicon detectors with a strip pitch of 80 μm (ATLAS) the minimum resolution is $\sim 23 \mu\text{m}$
- If the charge is collected by more than one strip, and if the charge sharing depends on the position of the particle impact the resolution can be substantially improved by calculating the center of gravity of the total signal

Tracker Technologies

Gas Detectors



Reminder: The Classic Ionization Chamber

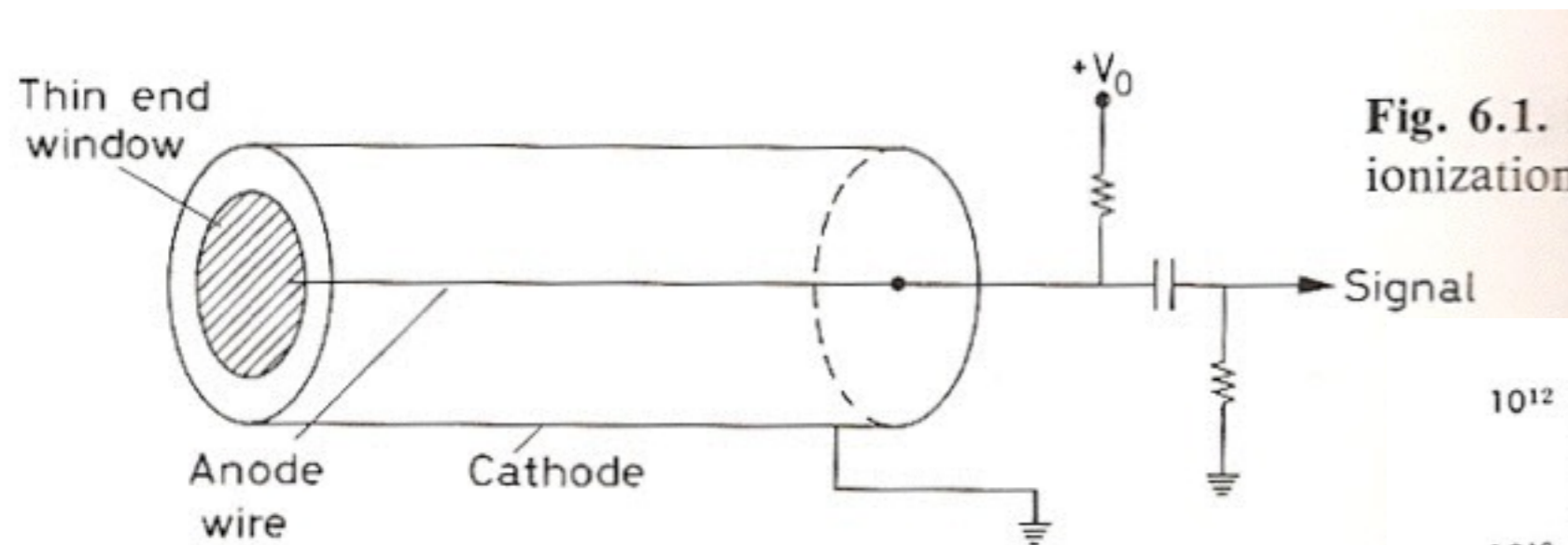
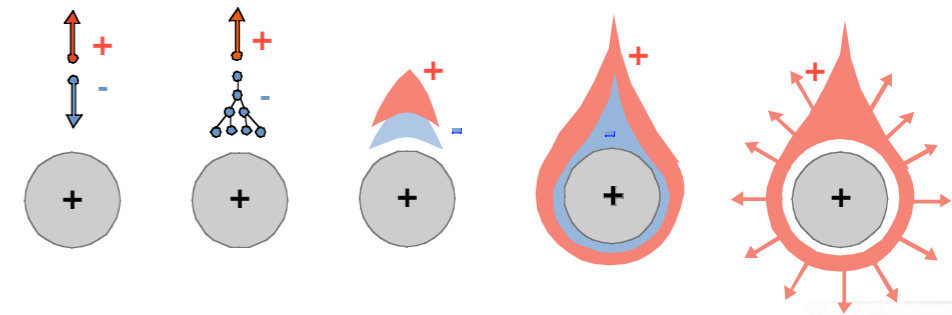
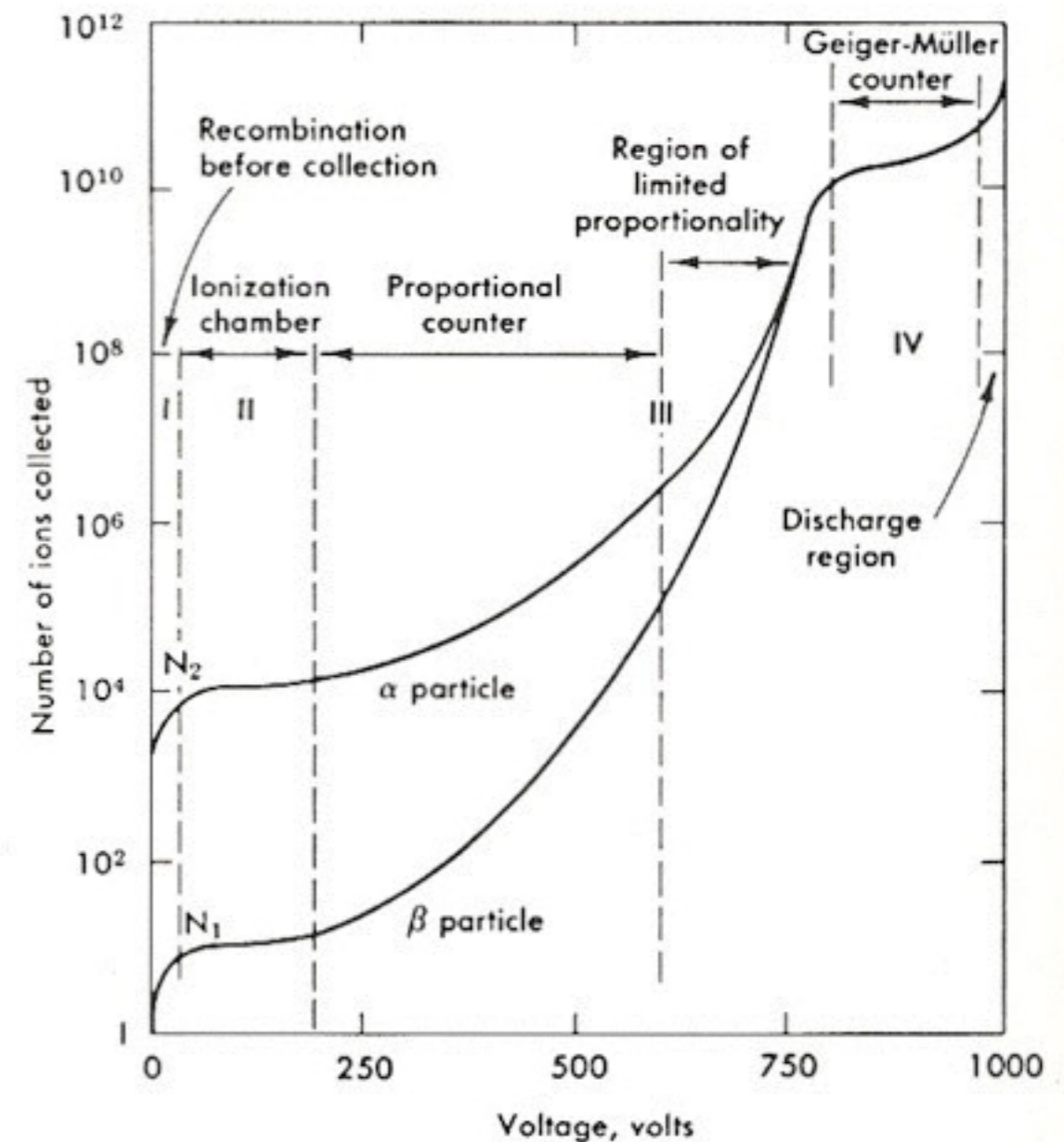

Fig. 6.1. Ionization



- Particles create electron-ion pairs in gas volume
- Electrons are accelerated in strong electric field, resulting in avalanche multiplication
- Depending on the applied voltage, the signal is proportional to the original energy deposition or goes into saturation



A Common Technique: Drift Tubes

- For example: ATLAS muon system

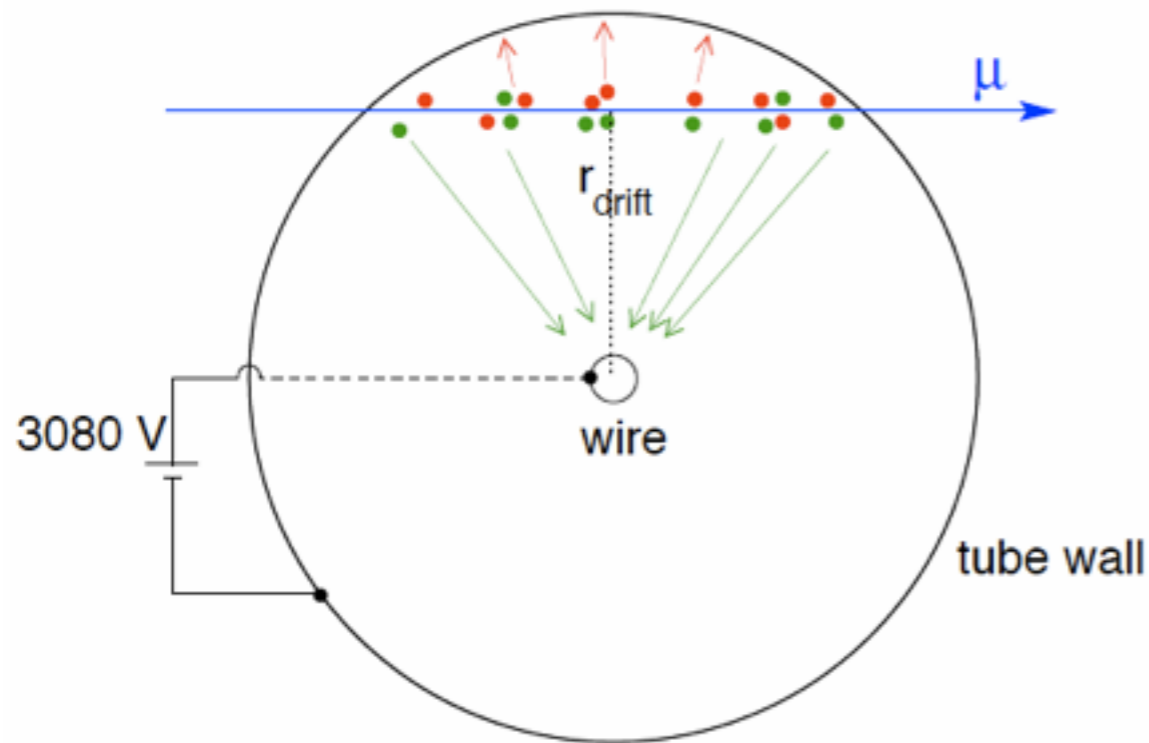

Measurement of the drift time: gives smallest distance to wire

⇒ Left/right ambiguity: Several staggered layers are required

⇒ Typical spatial resolution $\sim 100 \mu\text{m}$

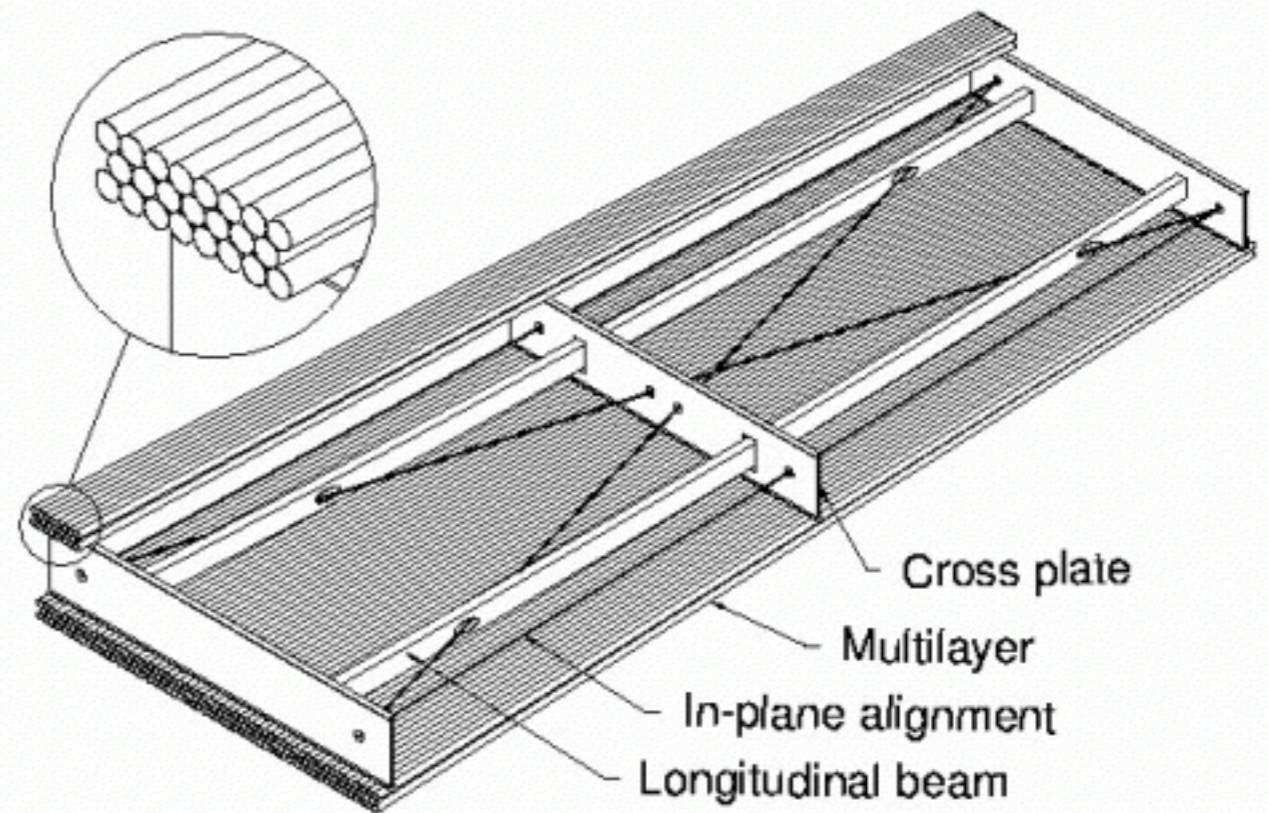

A Common Technique: Drift Tubes

- For example: ATLAS muon system

Measurement of the drift time: gives

smallest distance to wire

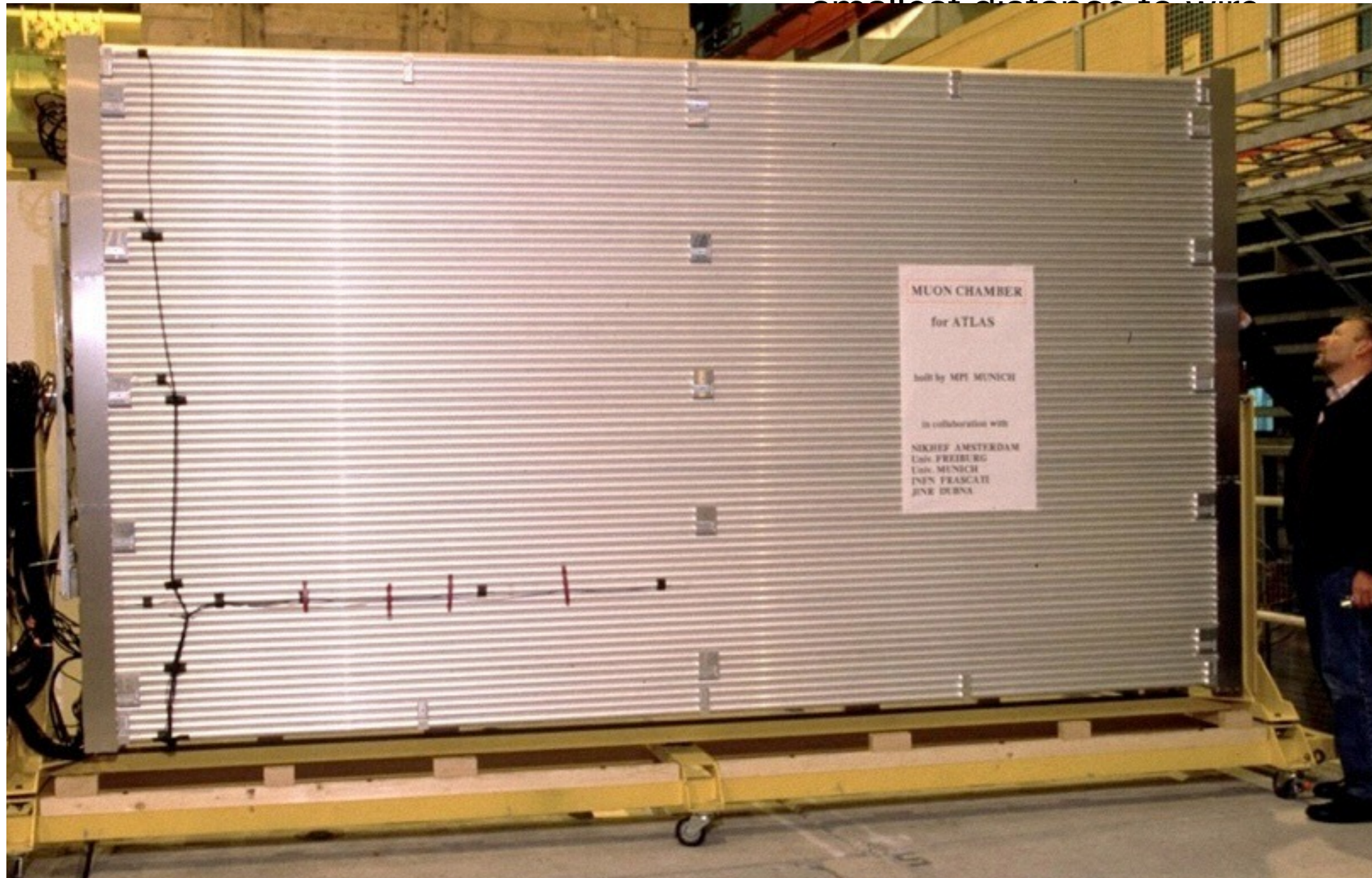

staggered

100 μm

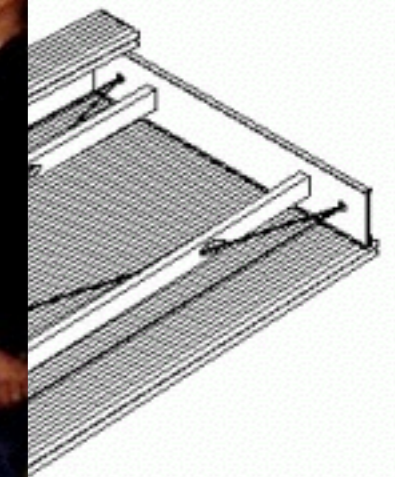

Cross plate

multilayer

alignment

beam

Foto: CERN

TPC: 3D Track Reconstruction

- The drift chamber idea - pushed further: Combination of 2D spatial information and time into real 3D point reconstruction

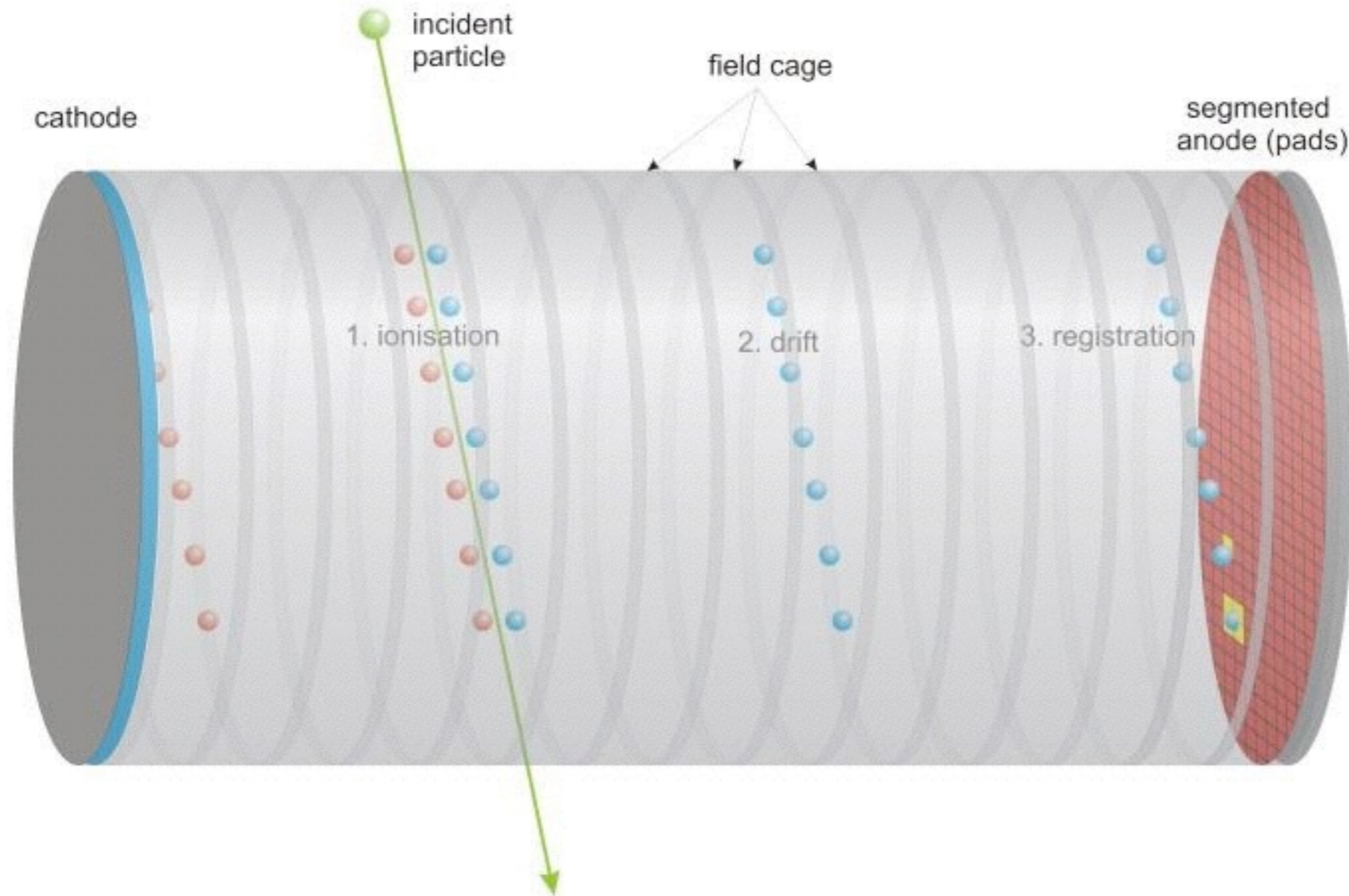

readout at the anode typically with MWPCs, newer technologies increasingly common

Schon länger im Einsatz: TPC bei STAR



Foto: LBL

- 4 m diameter, 4.2 m long

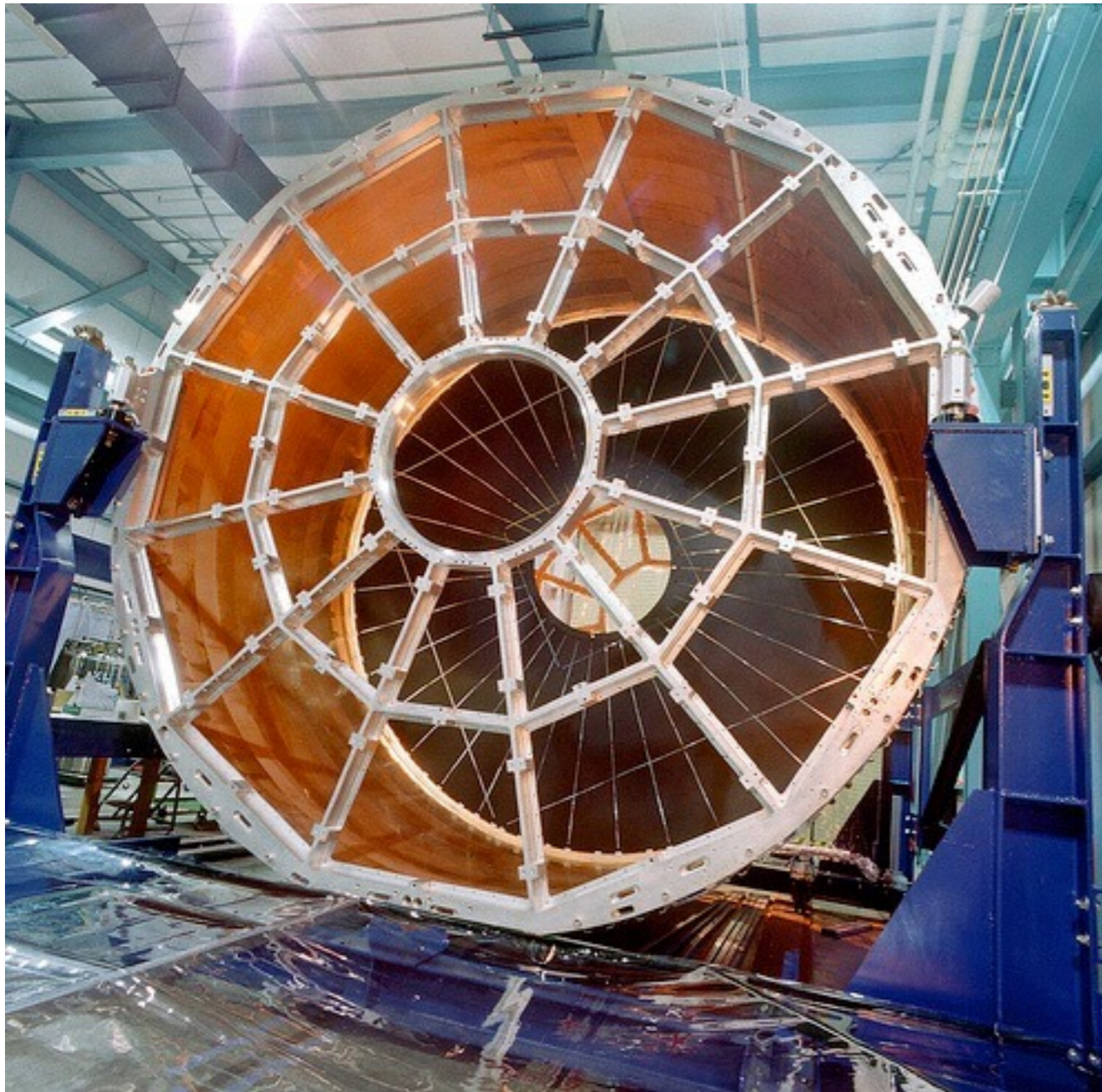
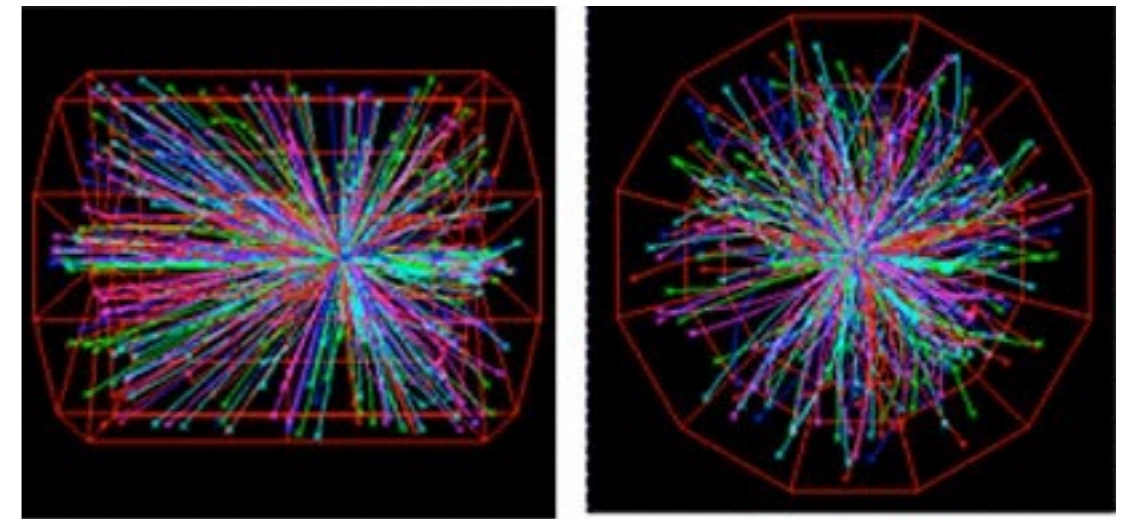

(a)

(b)

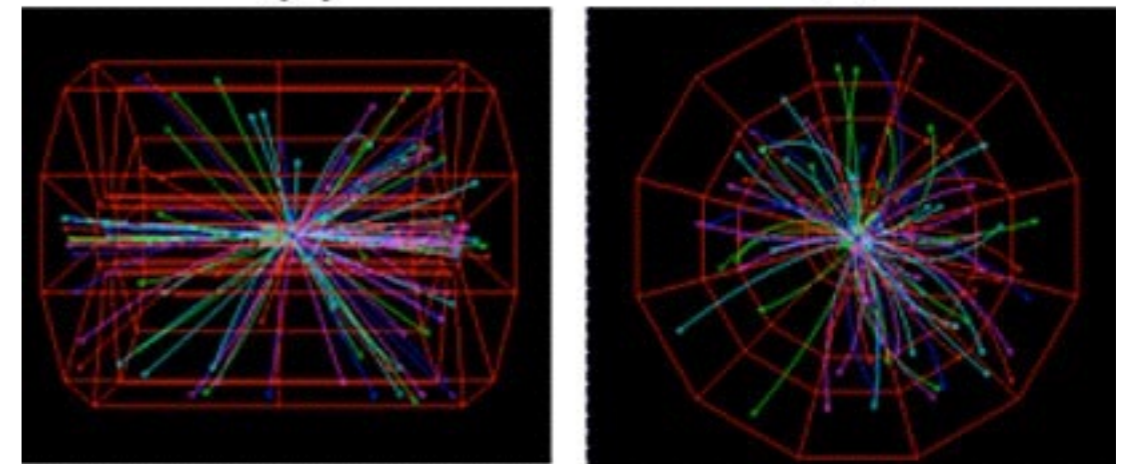

(c)

(d)

Events with low track multiplicity
Au+Au collisions at 9.2 GeV/nucleon

Schon länger im Einsatz: TPC bei STAR



Foto: LBL

- 4 m diameter, 4.2 m long

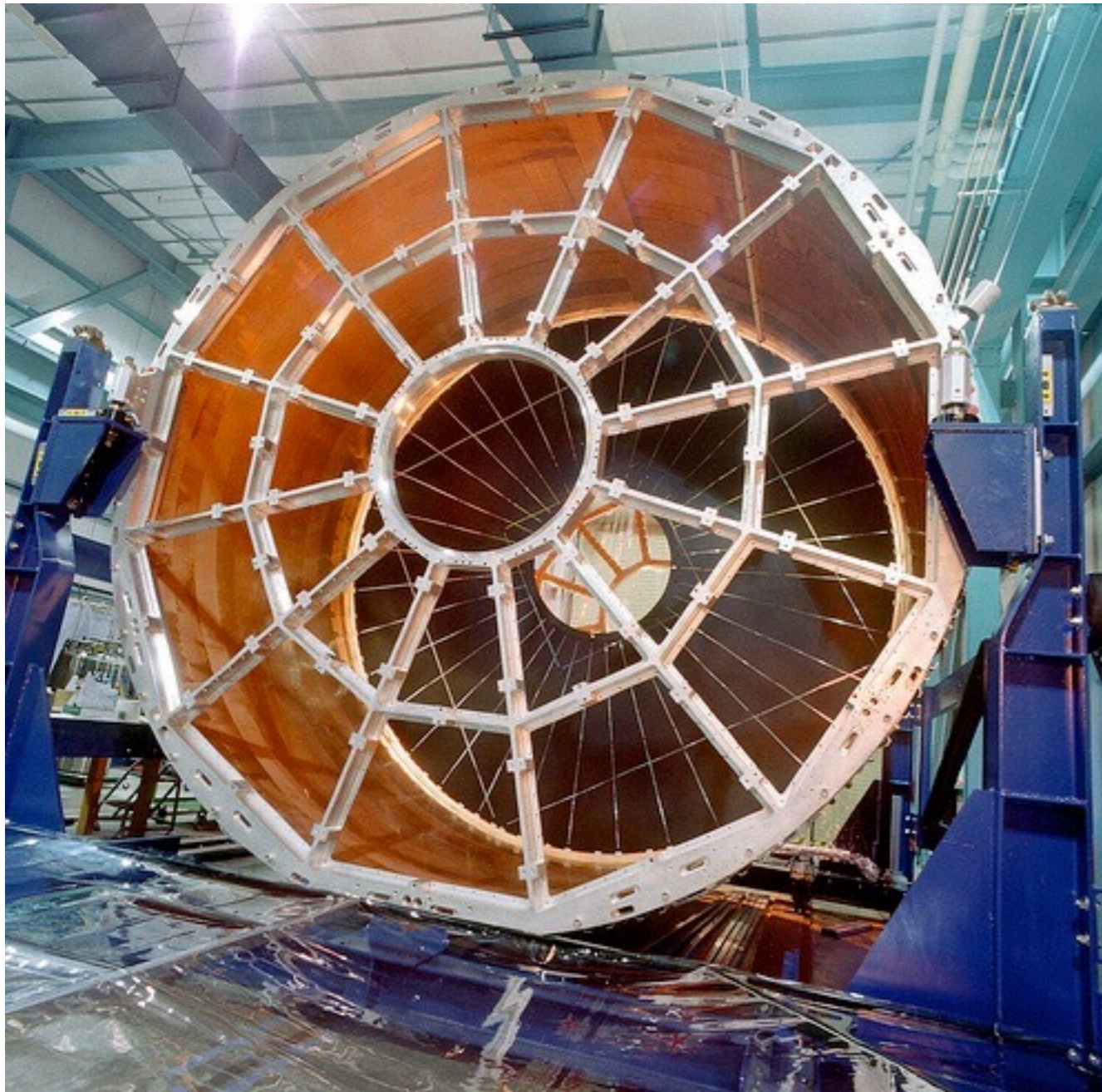
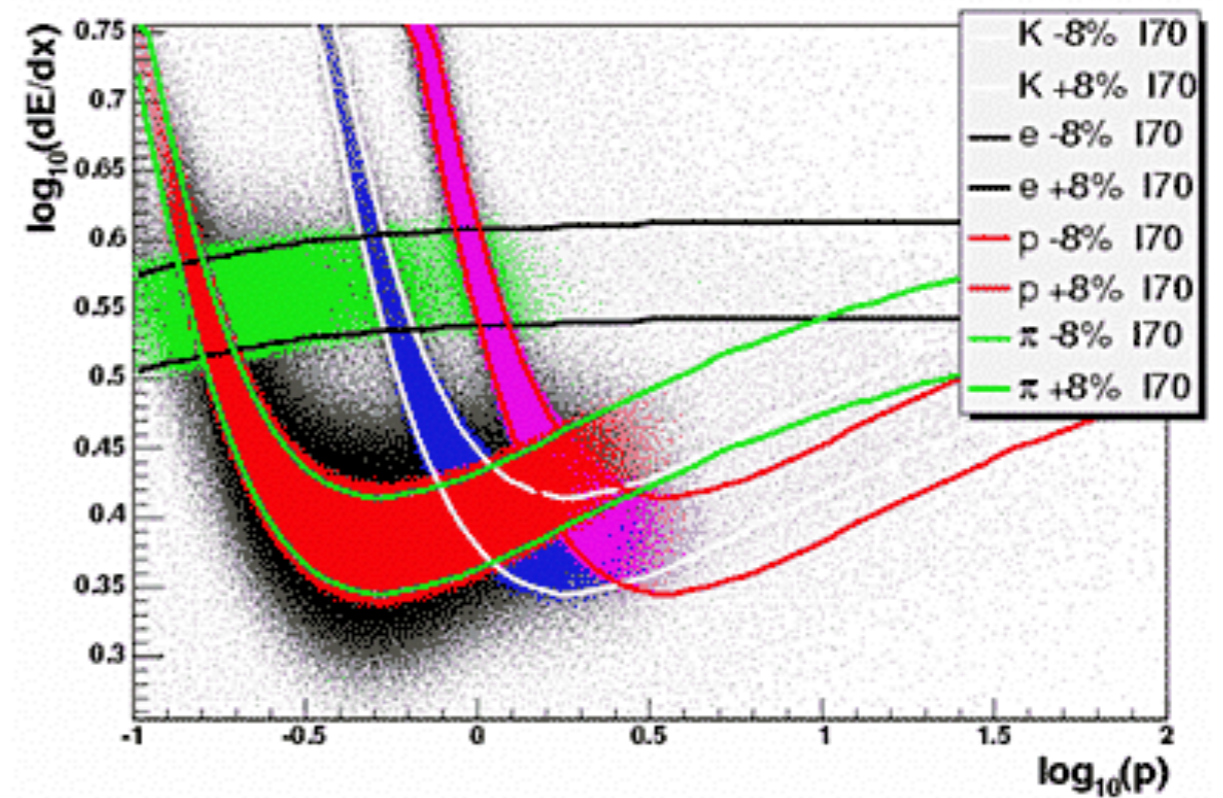

Particle identification via specific energy loss dE/dx

(pion ID also works at high energy!)

STAR TPC: Central Au+Au Collisions at 200 GeV

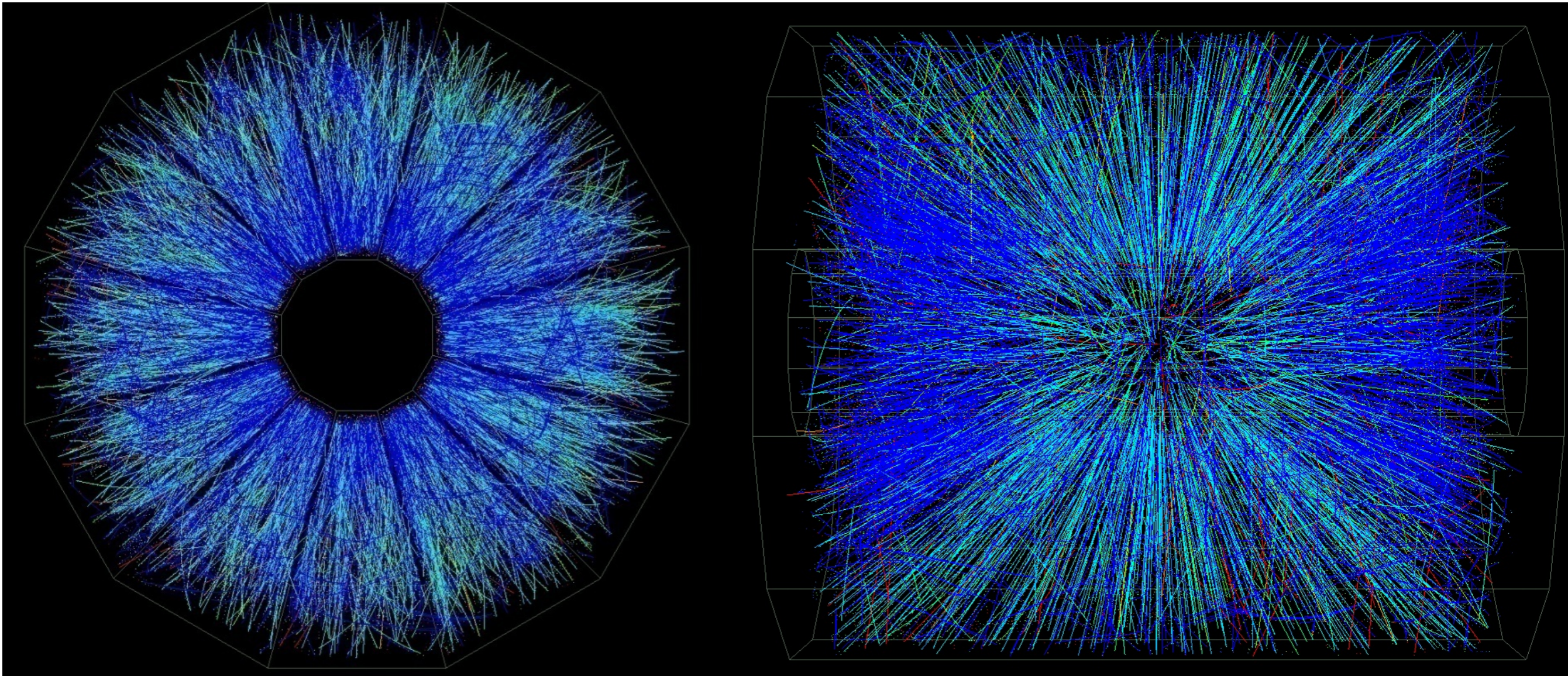

- TPCs can reconstruct complex events with many particles - several 1000 tracks
 - The limitation: Long readout times due to the drift time of electrons: $\sim 40 \mu\text{s}$

The biggest TPC: ALICE

- 4.9 m diameter, 5 m length

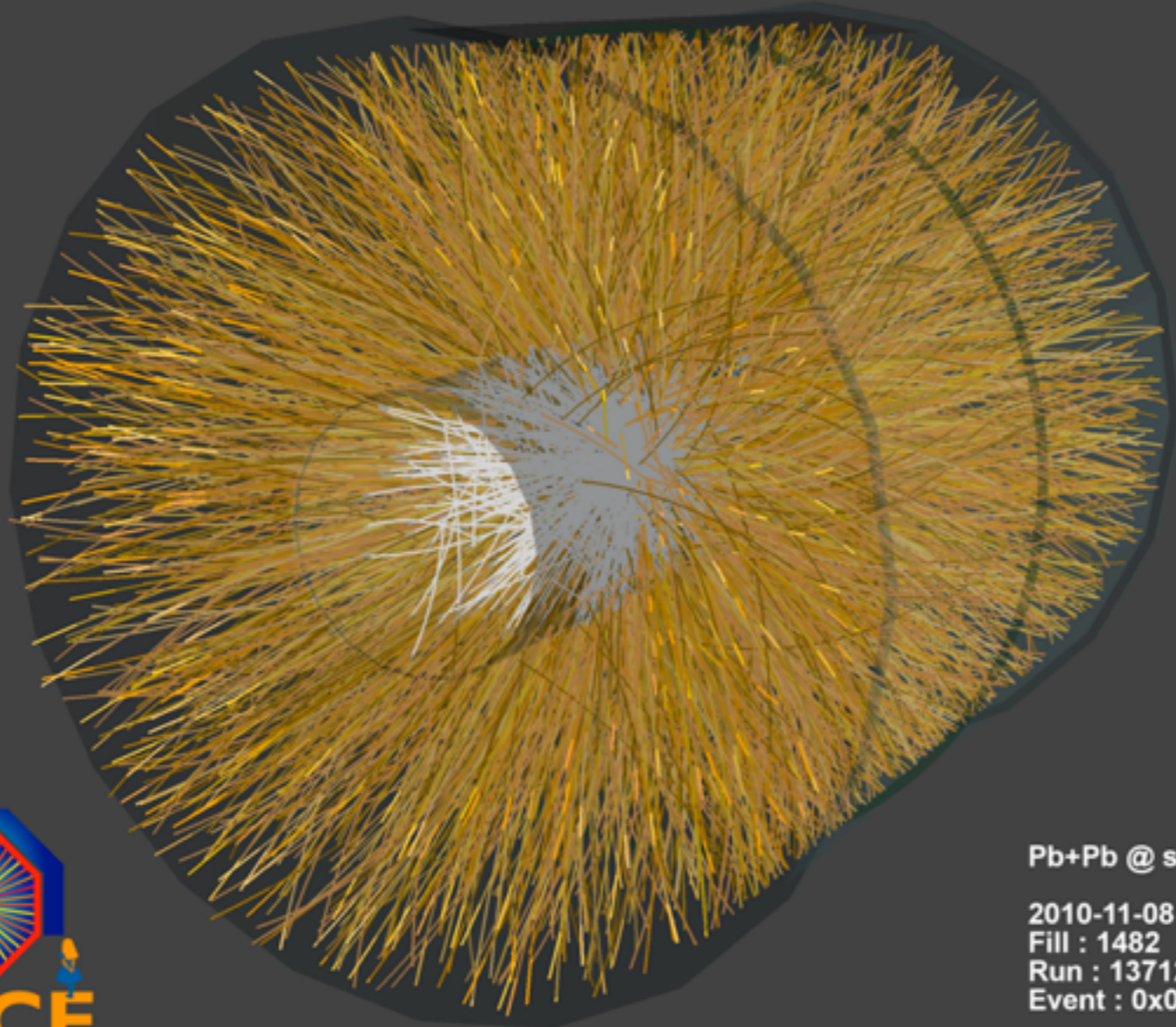

Pb-Pb collisions
at 2.76 TeV/
nucleon - many
thousand tracks
per event!



Pb+Pb @ sqrt(s) = 2.76 ATeV

2010-11-08 11:30:46

Fill : 1482

Run : 137124

Event : 0x00000000D3BBE693

Image: CERN

Tracker Technology: Semiconductor Detectors



Spatial Resolution: Strip Detectors

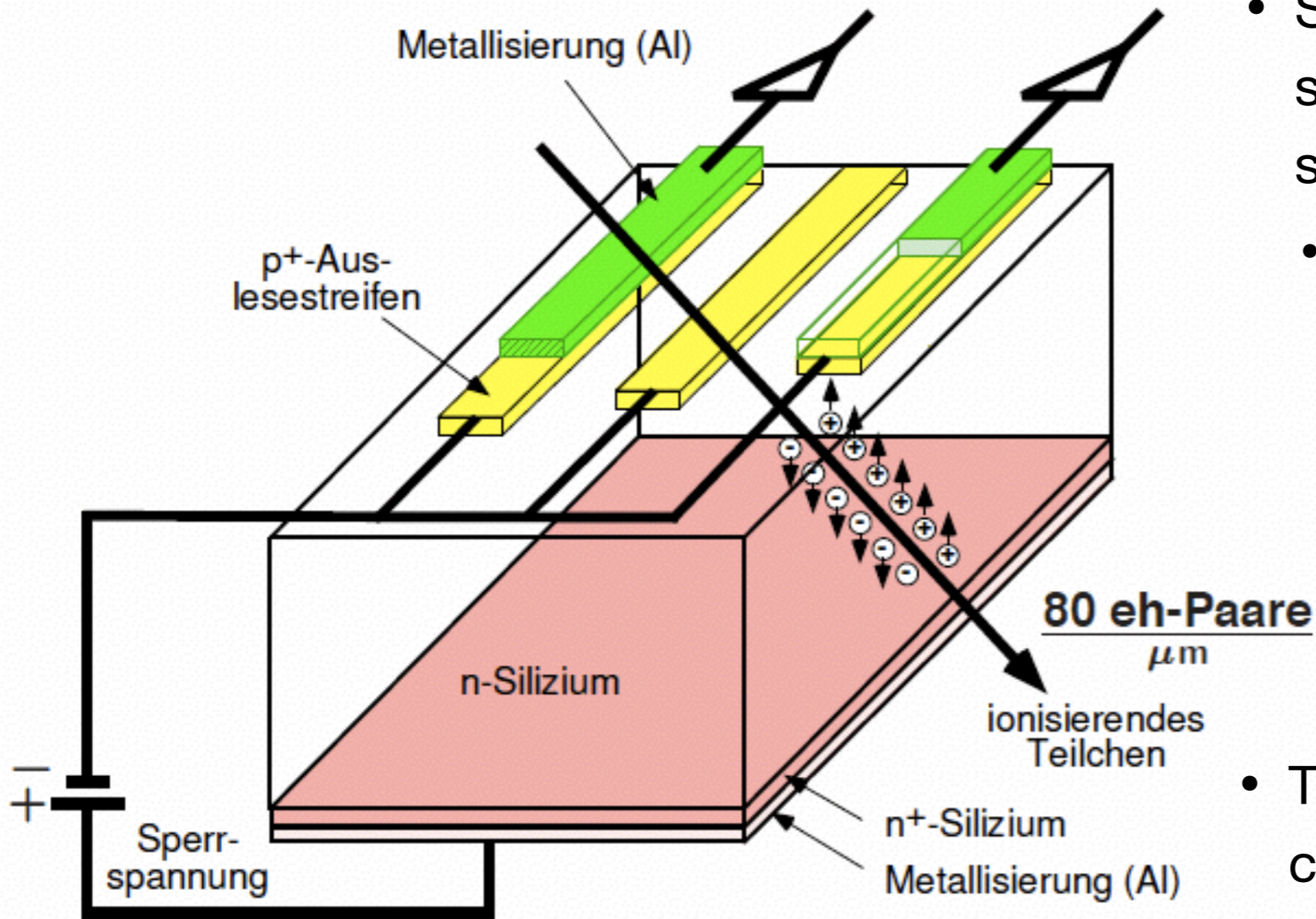

- Silicon allows very fine structures - ideal for high spatial resolution
- typical strip-to-strip distance $\sim 50 \mu\text{m}$
- The price to pay: Very high channel counts - Requires highly integrated electronics

2D - Resolution with Silicon

- 2D resolution can be provided by collection of electrons and holes on opposite sides of the sensor

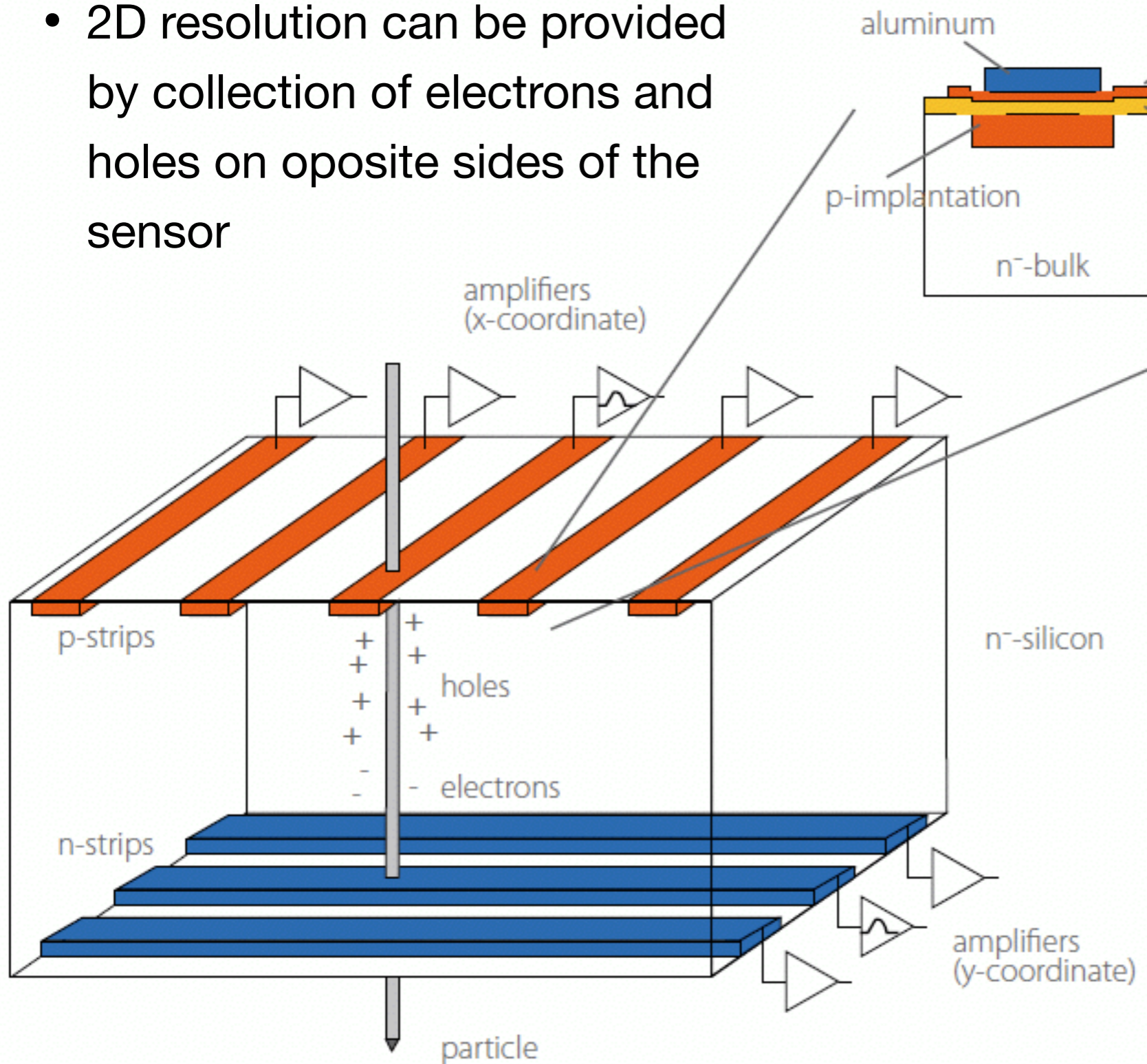

- Caveat: The electronics on one side has to be on high voltage instead of ground, due to the bias voltage across the sensor
- ▶ Complicates the detector infrastructure considerably, often avoided by using several single-sided layers with different strip orientation

The Limits of Strip Detectors

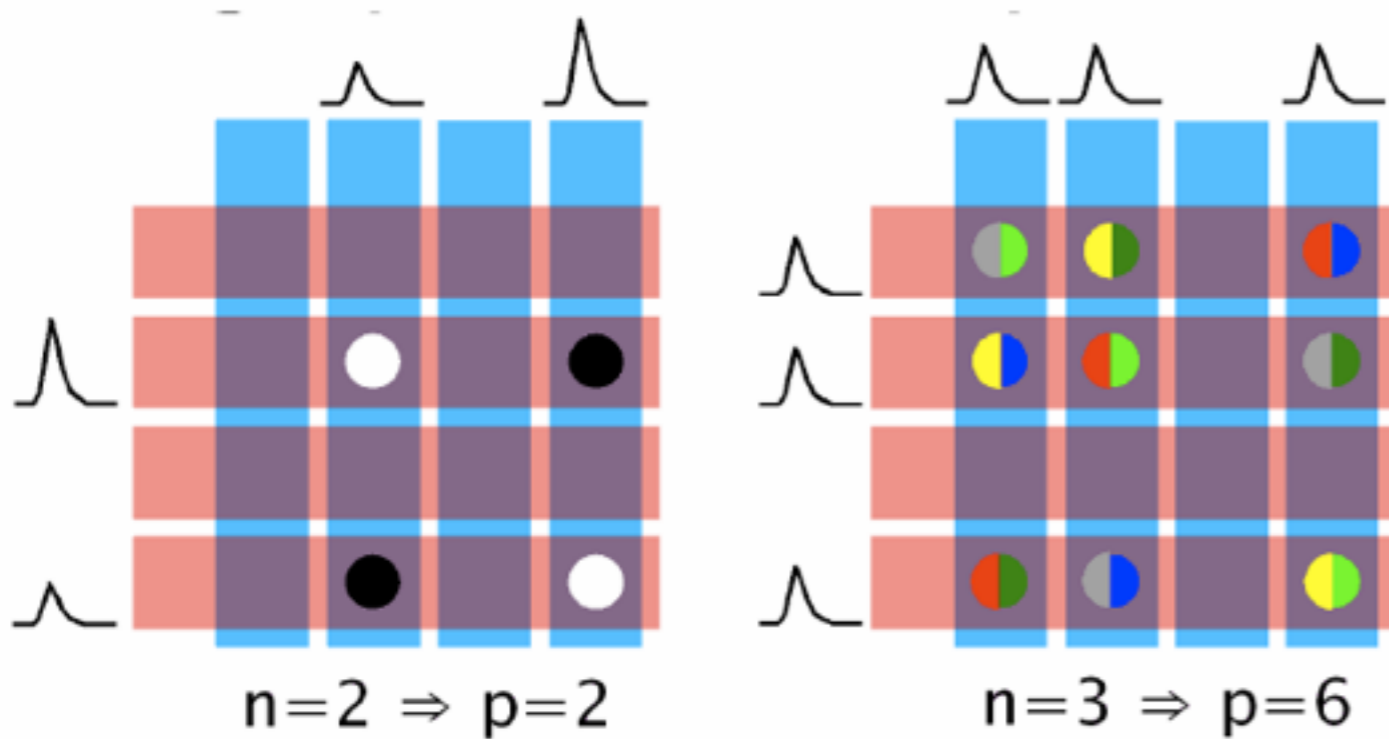

- For high particle densities there are ambiguities when going from 1D hits to 2D points: Track reconstruction collapses at some point

- Also: Spatial resolution typically only good in one coordinate (orthogonal to strip) - Insufficient to reconstruct secondary vertices

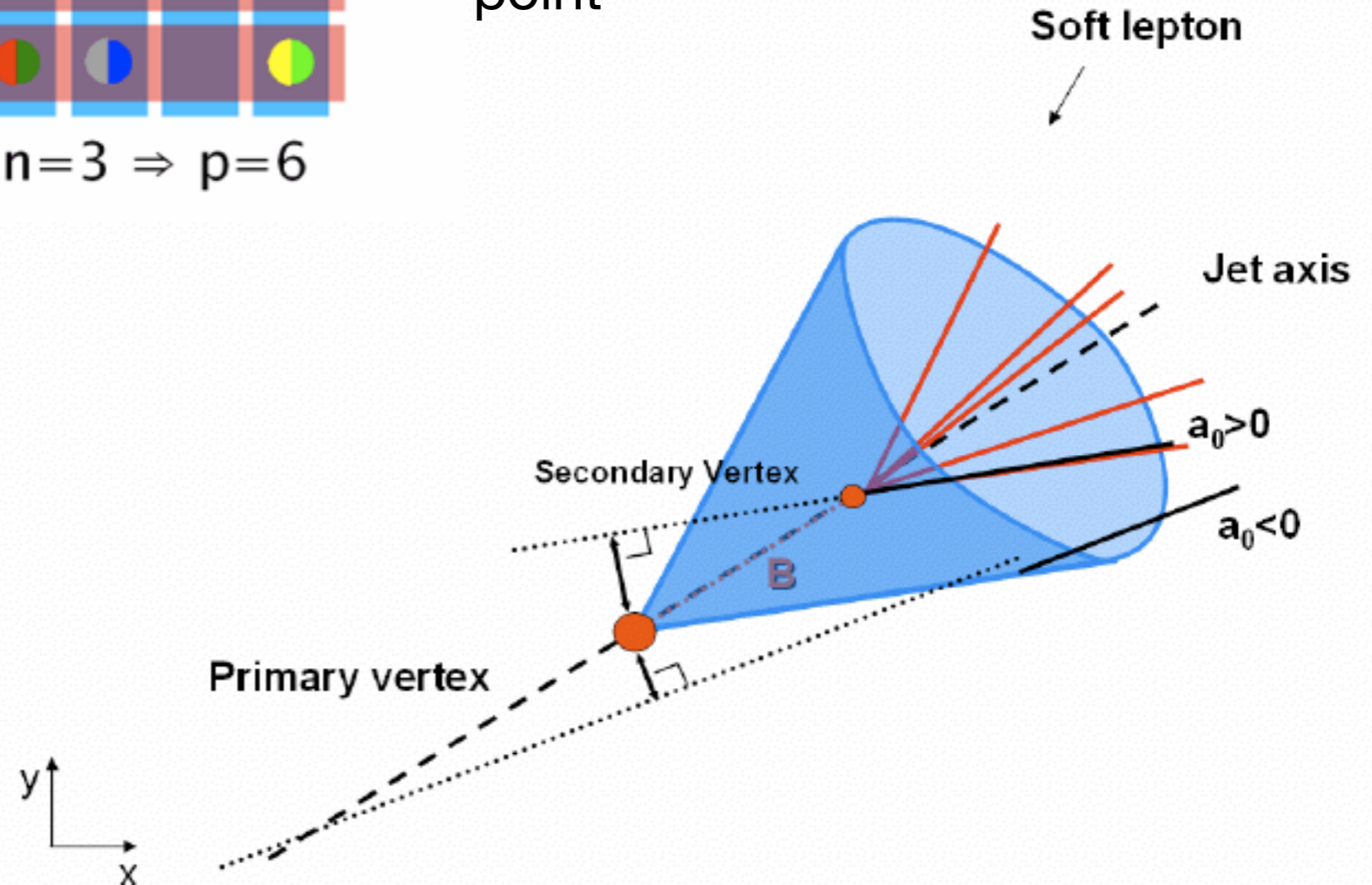

Pixel Detectors - The Principle

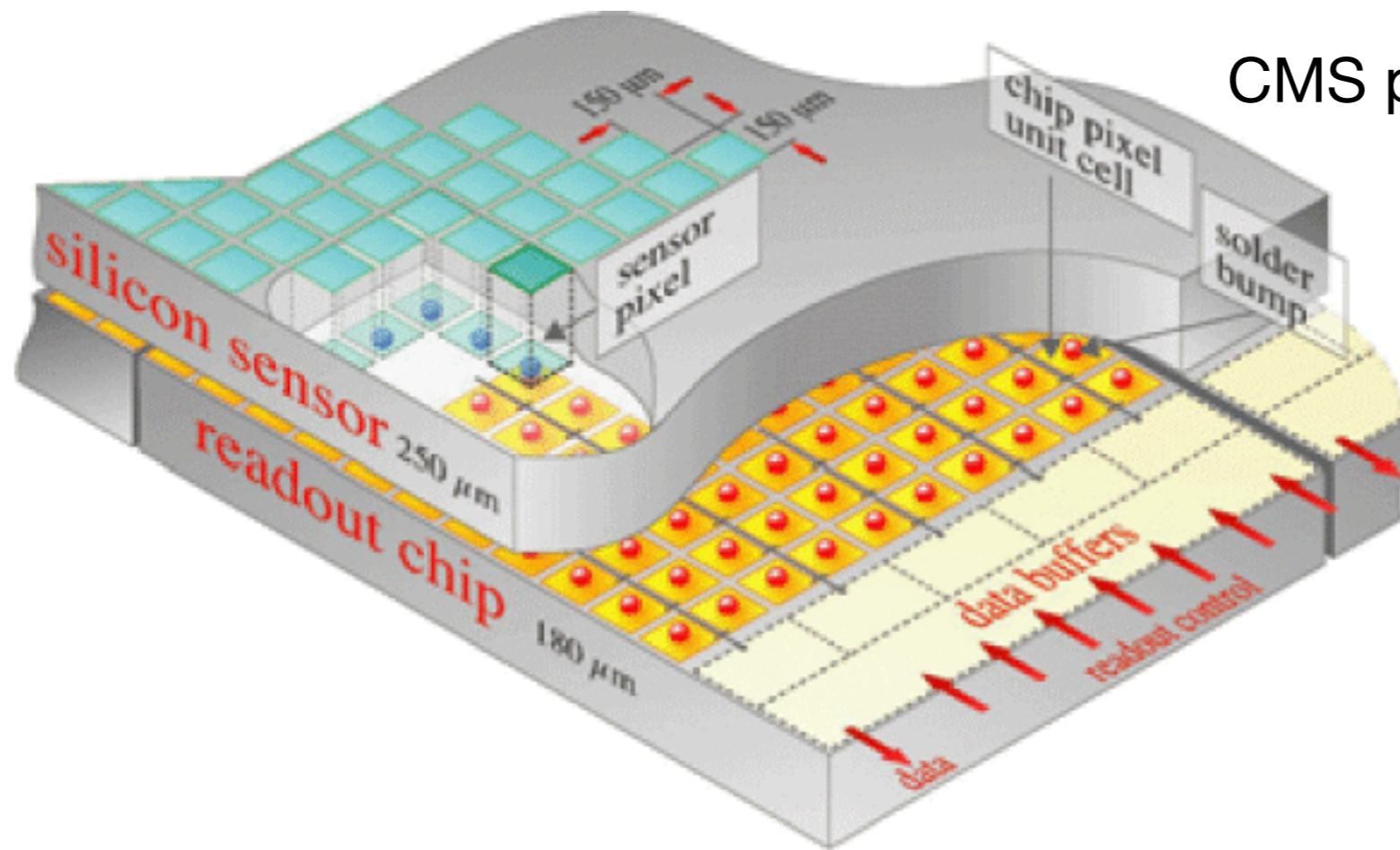

CMS pixel scheme

“Hybrid Pixels”

- CMS Pixels: ~65 M channels
150 x 150 μm
 - ATLAS Pixels: ~80 M channels
50 x 400 μm (long in z or r)
-
- Pixel-detectors allow tracking in environments with high particle density without ambiguities
 - Good spatial resolution in two coordinates with a single layer (depending on pixel size and charge sharing between pixels)
 - ▶ Very high channel count -> Challenging readout, in particular if it needs to be fast

Pixel Detectors - The Principle

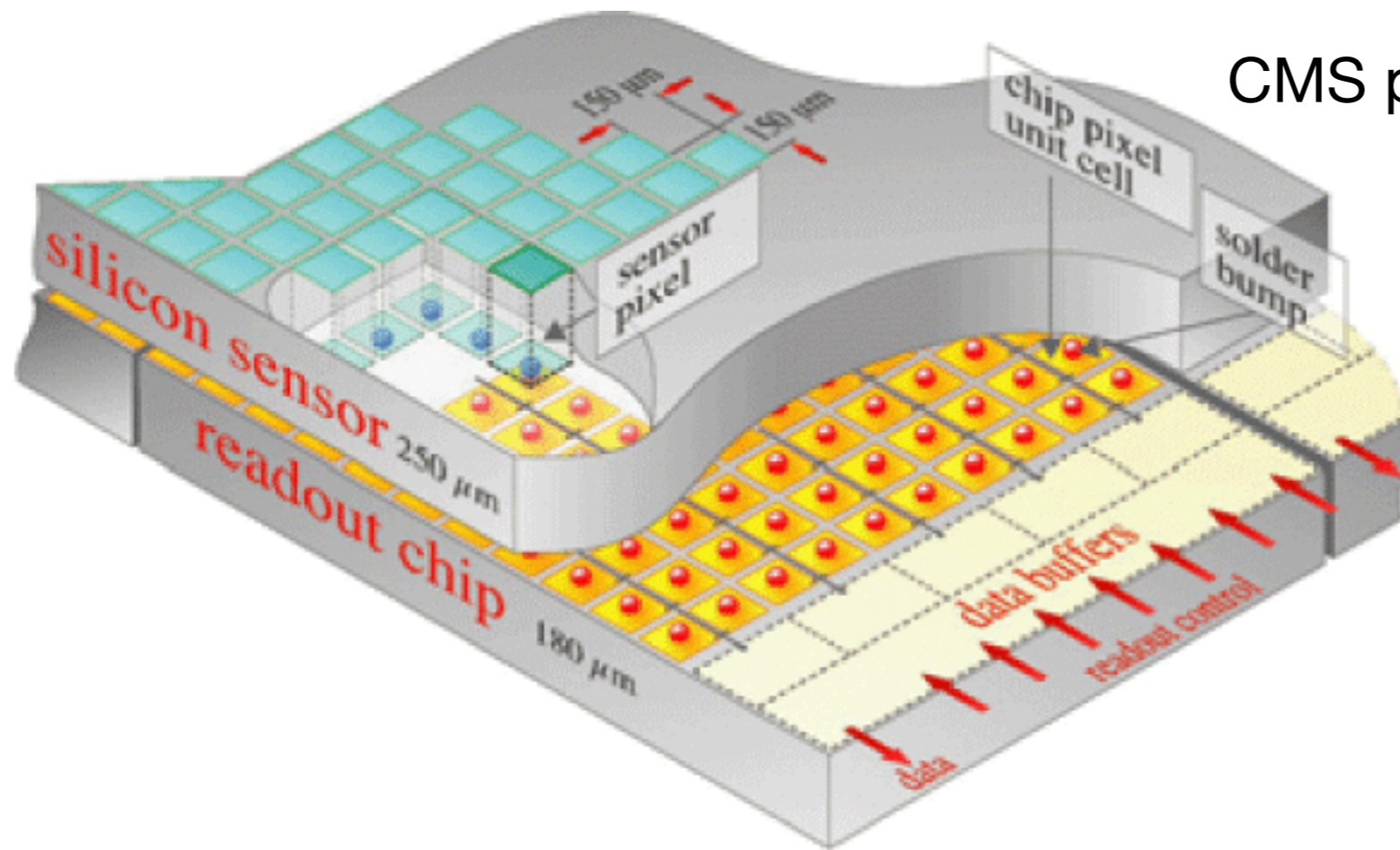

CMS pixel scheme

“Hybrid Pixels”

- CMS Pixels: ~65 M channels
150 x 150 μm
 - ATLAS Pixels: ~80 M channels
50 x 400 μm (long in z or r)
-
- Pixel-detectors allow tracking in environments with high particle density without ambiguities
 - Good spatial resolution in two coordinates with a single layer (depending on pixel size and charge sharing between pixels)
 - ▶ Very high channel count -> Challenging readout, in particular if it needs to be fast
... relatively high material budgets with fast readout: separate electronics layer!

ATLAS Pixels: A Closer Look

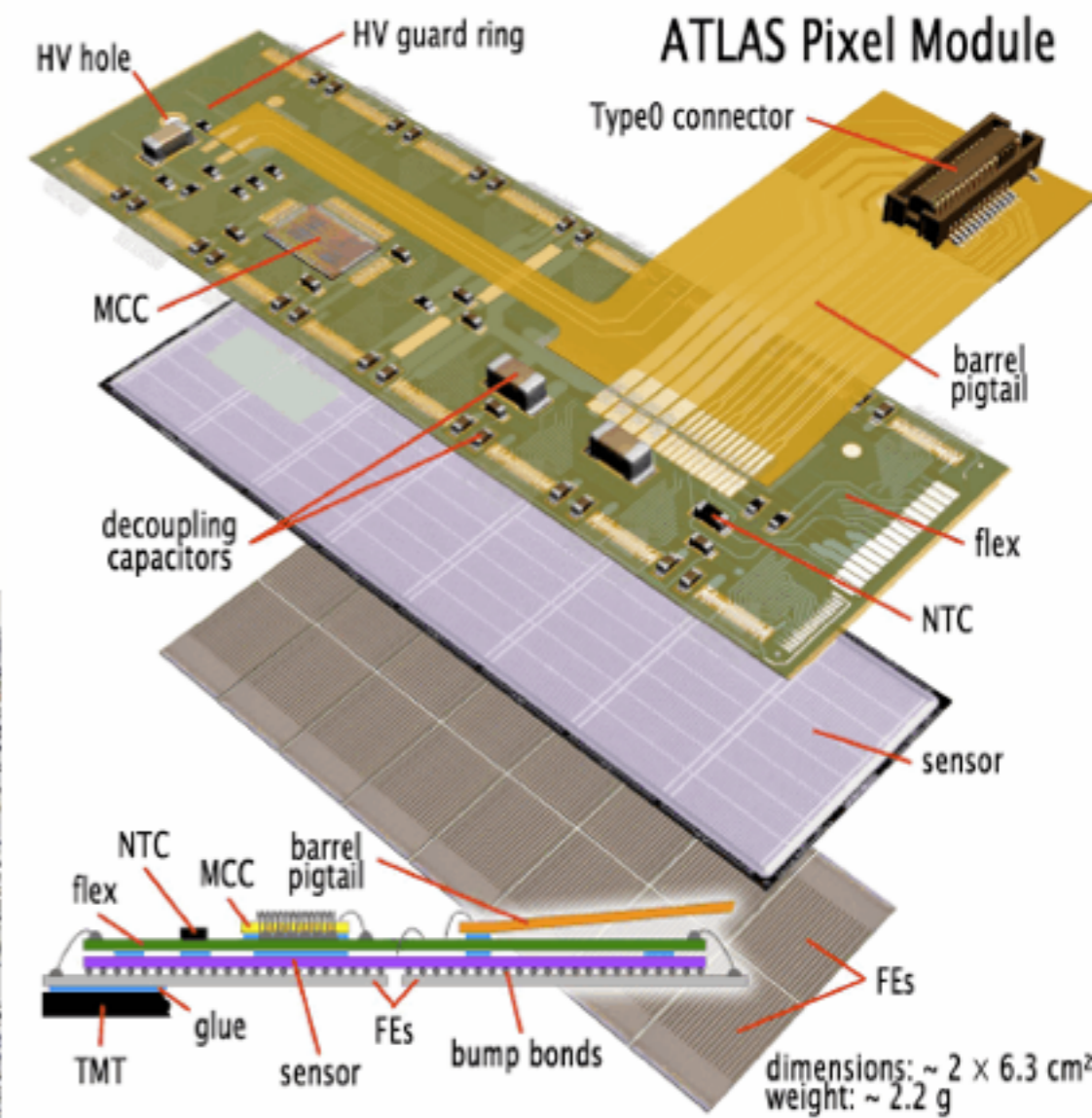
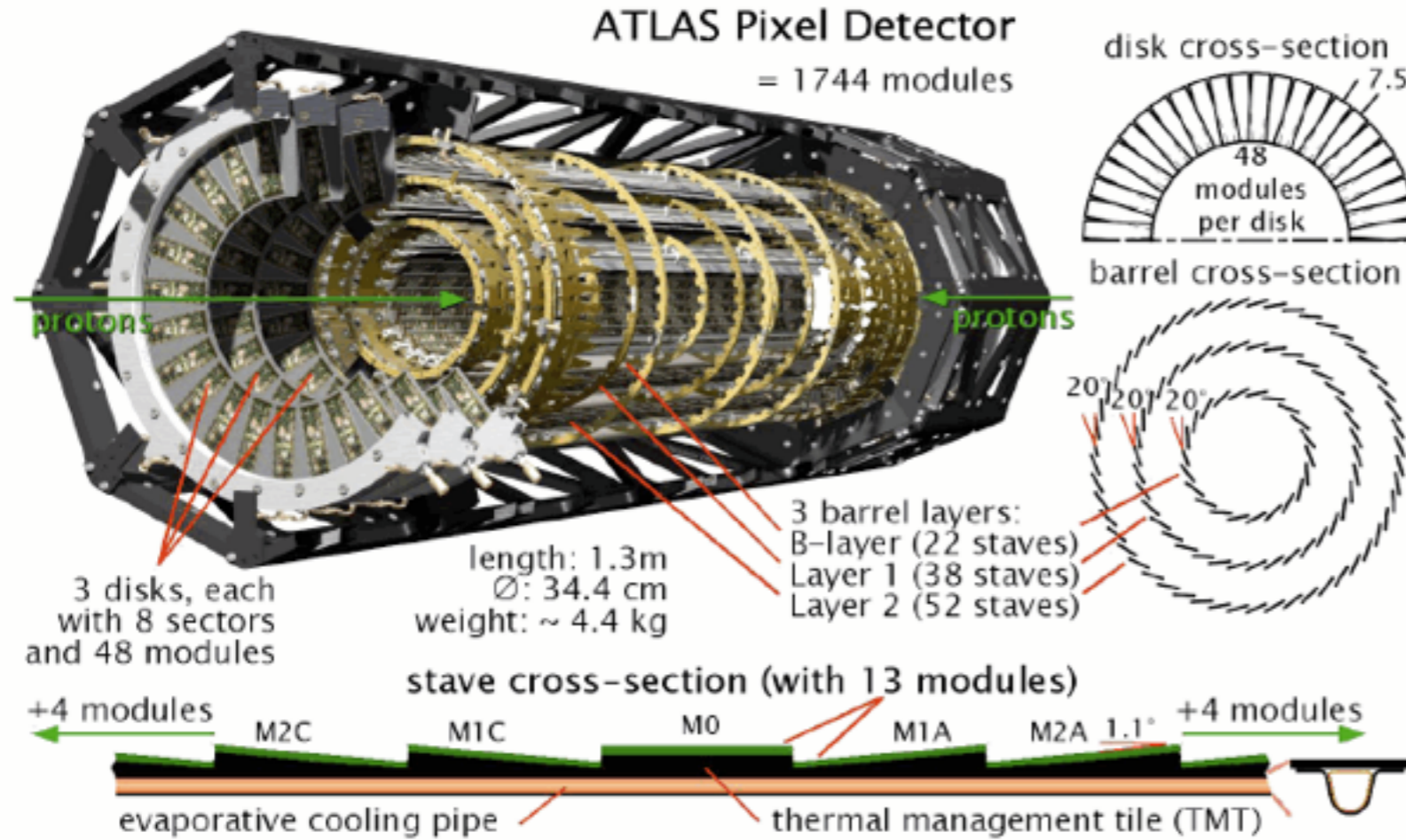

Technologies for the Future: 3D Silicon

- The dream: All on a single chip
 - sensitive detector
 - analog pulse shaping
 - digitization
 - communication and control

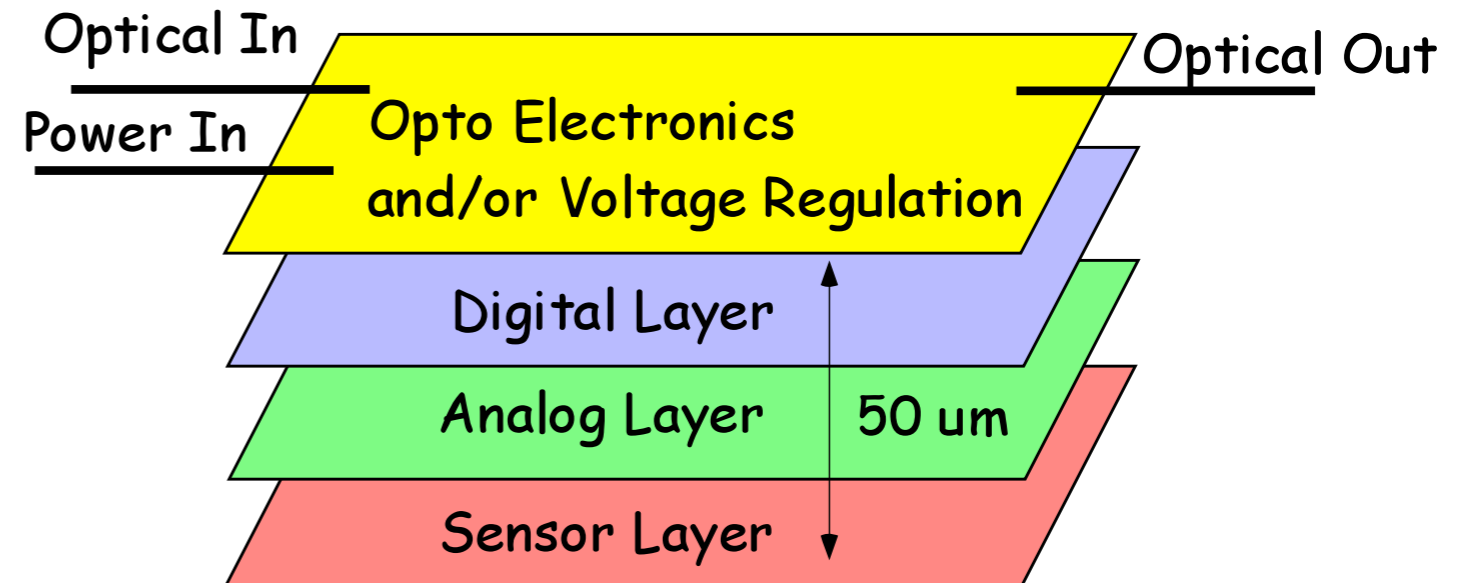

Technologies for the Future: 3D Silicon

- The dream: All on a single chip
 - sensitive detector
 - analog pulse shaping
 - digitization
 - communication and control
- Use of several thin Si layers which can be based on different processing technologies
- Important: The electrical connection between the different layers

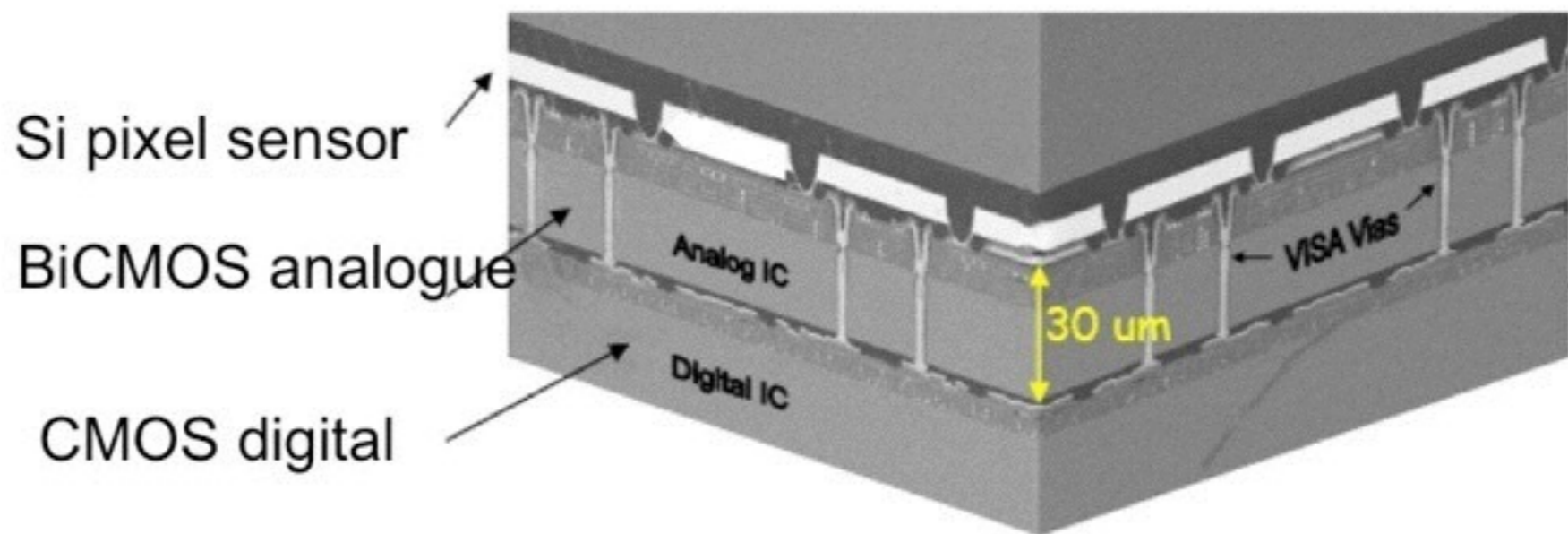
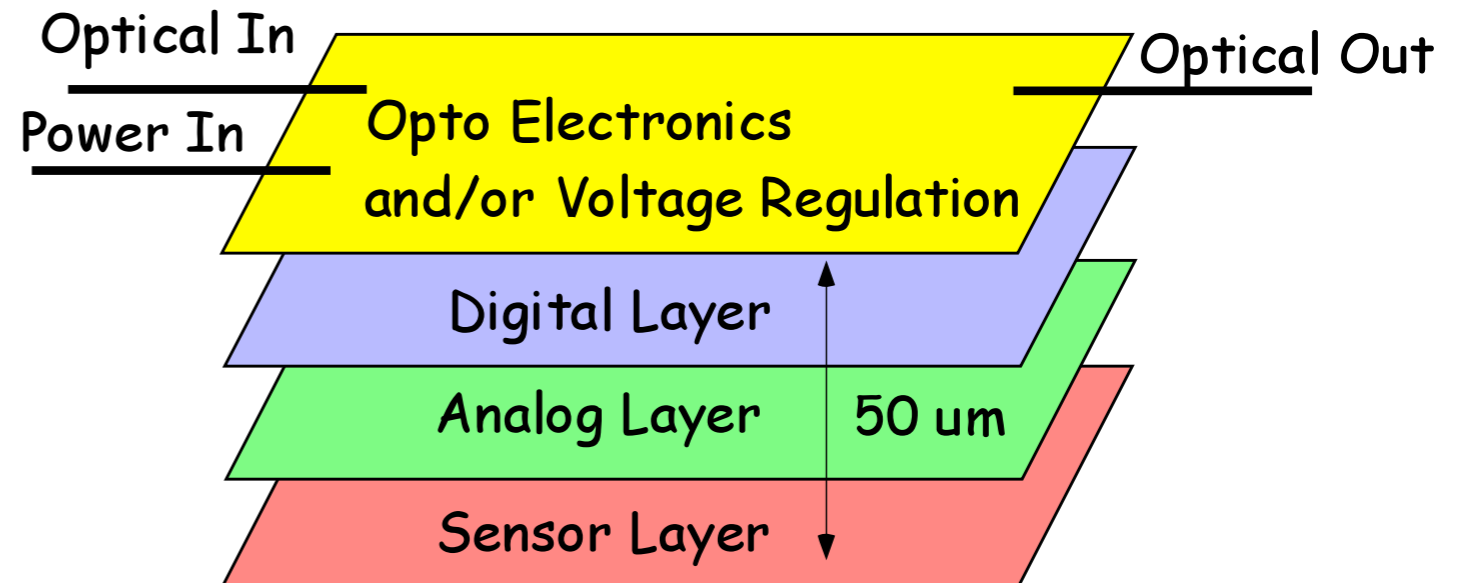

At the moment different technologies are being developed and tested...

Calorimetry: Energy Measurement

The Concept

- Originally from chemistry: Measurement of the released heat by a chemical reaction: Here increase of temperature of a well-known amount of water
- For elementary particles: Measurement of the energy of a particle by total absorption
 - $1 \text{ cal} = 10^7 \text{ TeV}$: Very small energies, no temperature increase!
 - ▶ Somewhat more sophisticated strategy for energy measurement needed

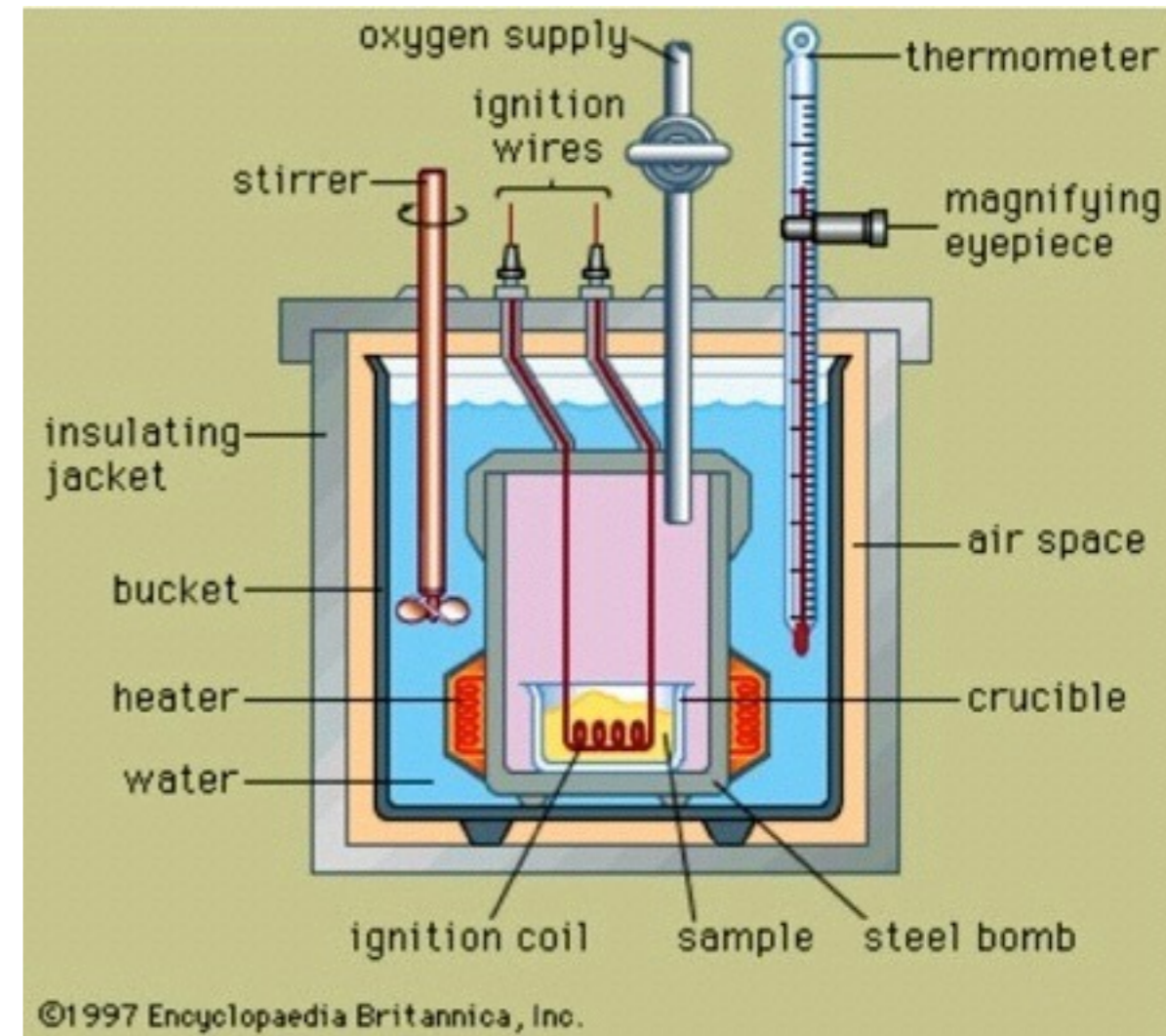

Measuring Energy with a Calorimeter

- Convert the energy of the incident particle to a detector response
- Choose something that is easily detectable also for “small” energies
 - Electric charge
 - Photons (in or close to visible range)

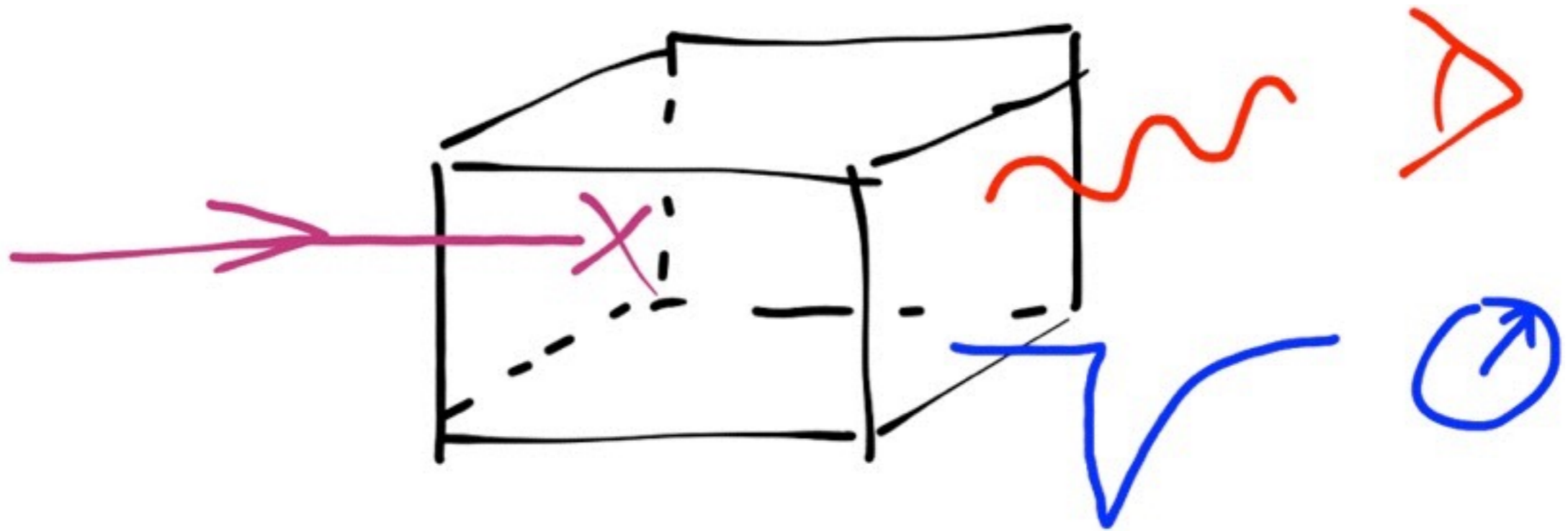

Measuring Energy with a Calorimeter

- Convert the energy of the incident particle to a detector response
- ▶ Choose something that is easily detectable also for “small” energies
 - ▶ Electric charge
 - ▶ Photons (in or close to visible range)

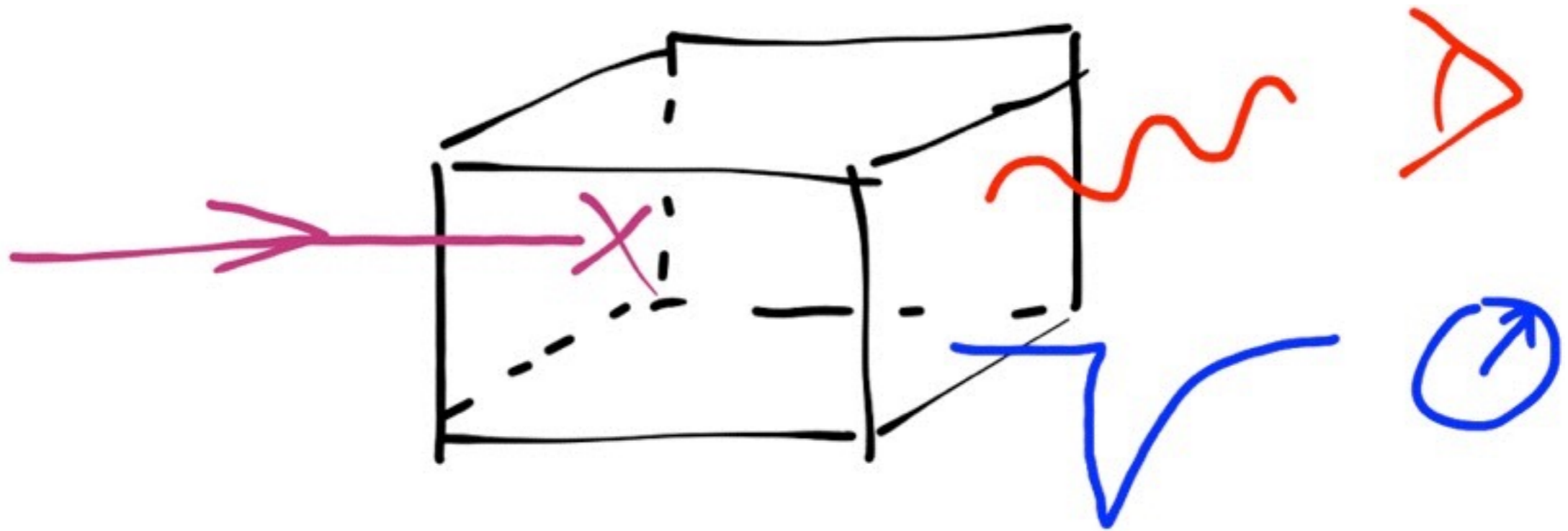

N.B.: Also other channels are used - thermal for example in cryogenic DM-search experiments, acoustic measurements, ... Not covered here!

Measuring Energy with a Calorimeter

- Calorimetric processes are stochastic:
 - Counting of photons / created charge carriers
 - Number of secondary particles in showers induced by high-energy particles

Energy resolution often well-described by

$$\frac{\sigma}{E} = \frac{a}{\sqrt{E}} \oplus \frac{b}{E} \oplus c$$

- Three components:
 - a : The **stochastic** term: The counting aspect of the measurement: Simple statistical error: scales with the square root of the number of particles
⇒ Resolution term scales with $1/\sqrt{E}$
 - b : The **noise** term: Constant, energy-independent noise contribution to the signal -
⇒ Resolution term scales with $1/E$
 - c : The **constant** term: Contributions that scale with energy: Influence of inhomogeneities in the detector material, un-instrumented or dead regions, ...
⇒ Resolution term is independent of energy

Calorimeter Types

- The dream: Contain the full energy of one particle, convert all energy into a measurable signal which is linear to the deposited energy
- Reality is often different, in particular when measuring hadrons

Two types: **homogeneous calorimeters** and *sampling calorimeters*

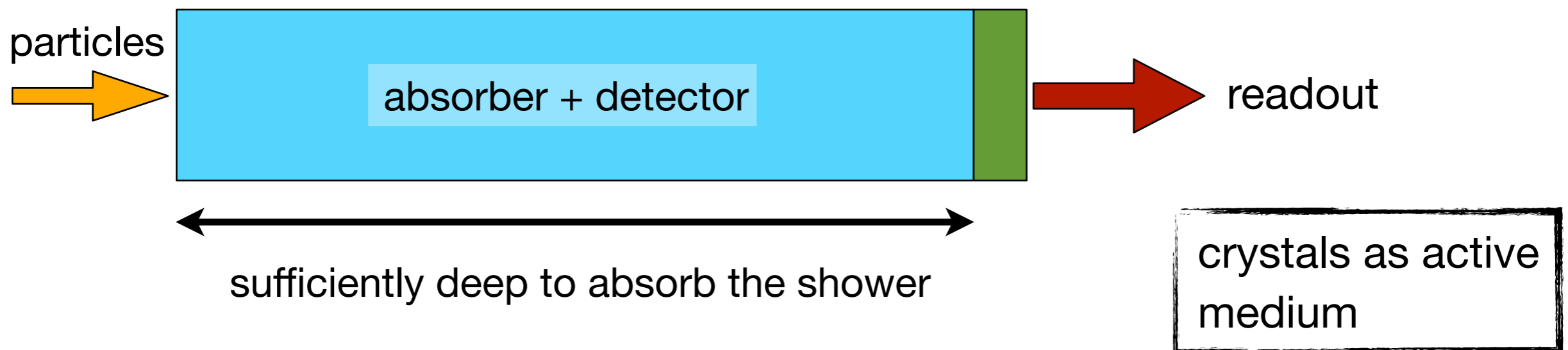

- The shower develops in the sensitive medium
 - Potentially optimal energy resolution: Complete energy deposit is measured
 - Challenging readout: No passive readout structures in detector volume

Calorimeter Types

- The dream: Contain the full energy of one particle, convert all energy into a measurable signal which is linear to the deposited energy
- Reality is often different, in particular when measuring hadrons

Two types: *homogeneous calorimeters* and *sampling calorimeters*

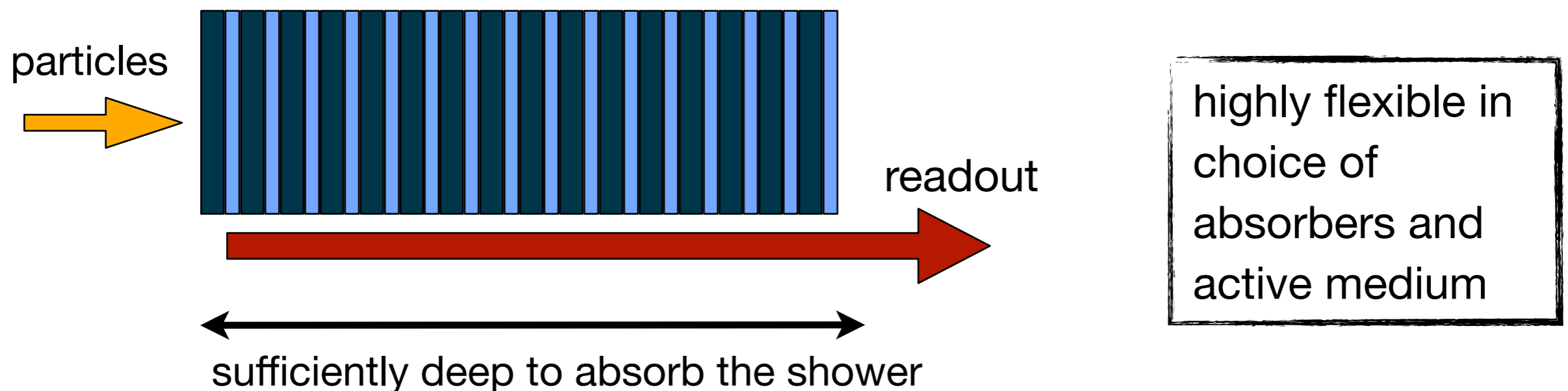

- The shower develops (mostly) in dense absorber medium, particles are detected in interleaved active structures
- Potentially reduced energy resolution: Only a fraction of the deposited energy is detected

Particle Showers

- Measurement of highly energetic particles: Showers
 - Electromagnetic: Successive pair creation / Bremsstrahlung

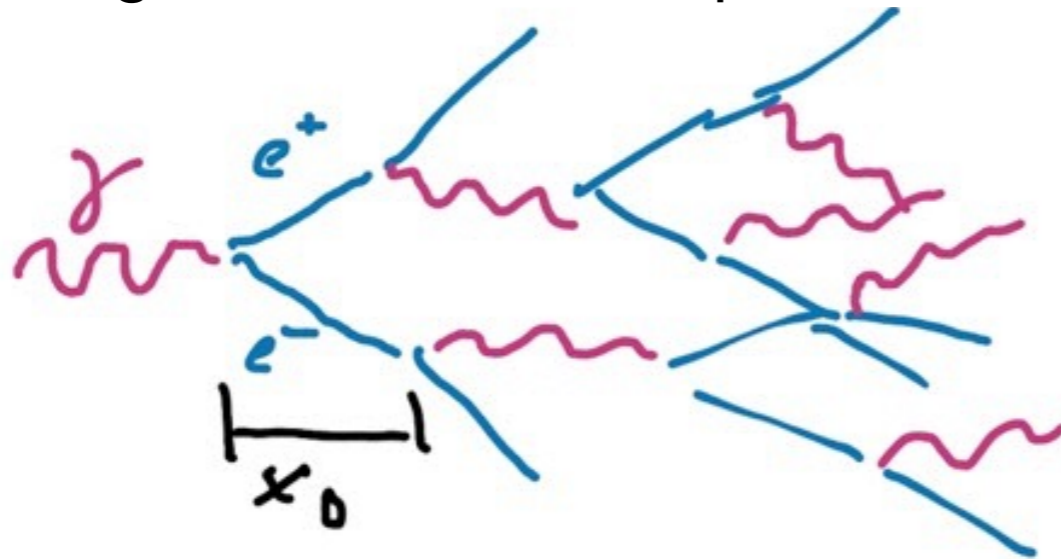

- Hadronic: Hadronic cascade with hadronic and em content

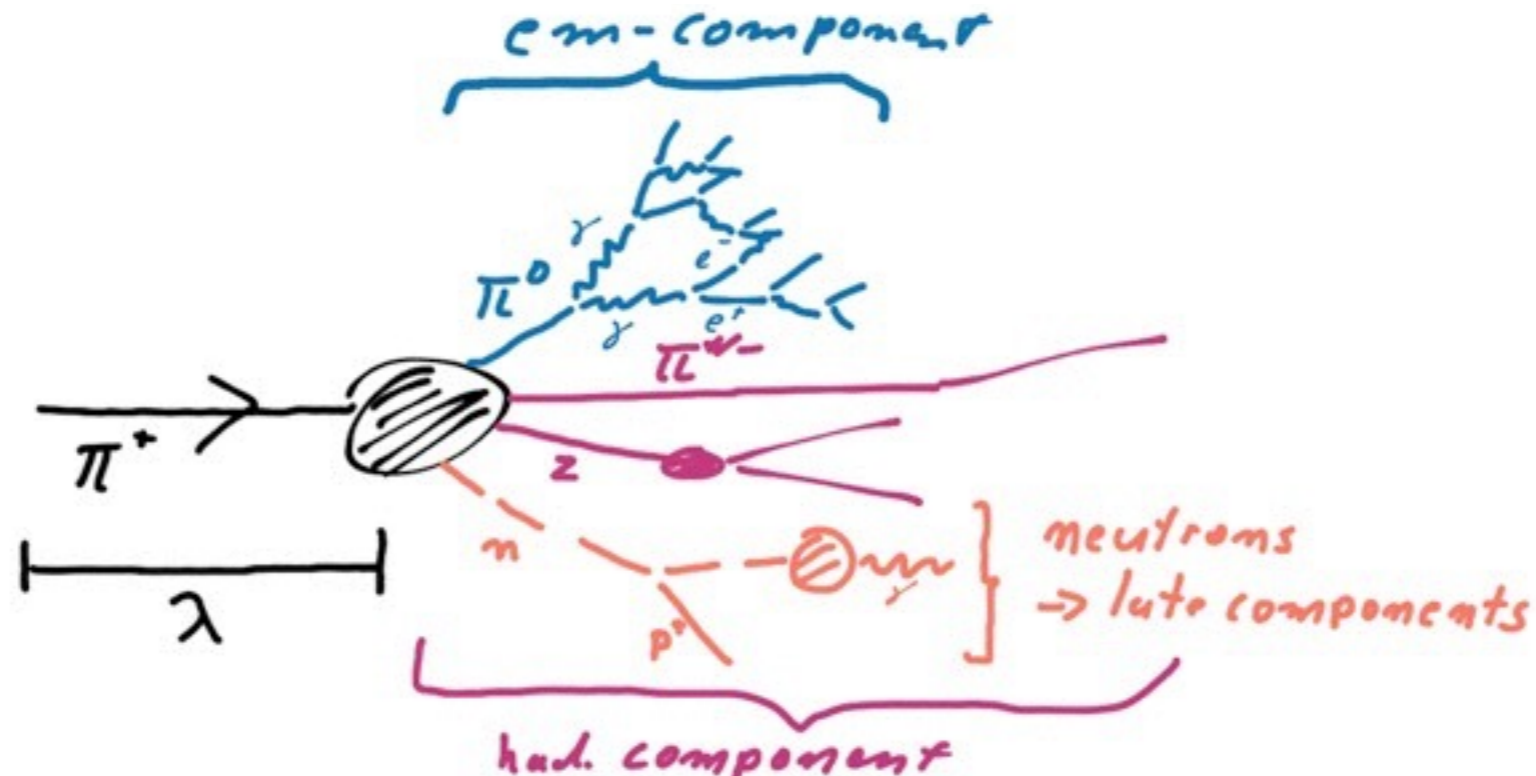

Characteristic Parameters of Showers - EM

- Longitudinal development described by X_0
- Lateral shower size given by Moliere Radius ρ_M (also depends on X_0)
90% of all energy is contained in a cylinder with a radius of $1 \rho_M$ around the shower axis
- Shower maximum: Depth where number of particles in the shower is maximal
 - $t_{\max} \sim \ln(E_0/\varepsilon) + t_0$ in X_0 , with $t_0 = -0.5$ für e^- , $+0.5$ für γ

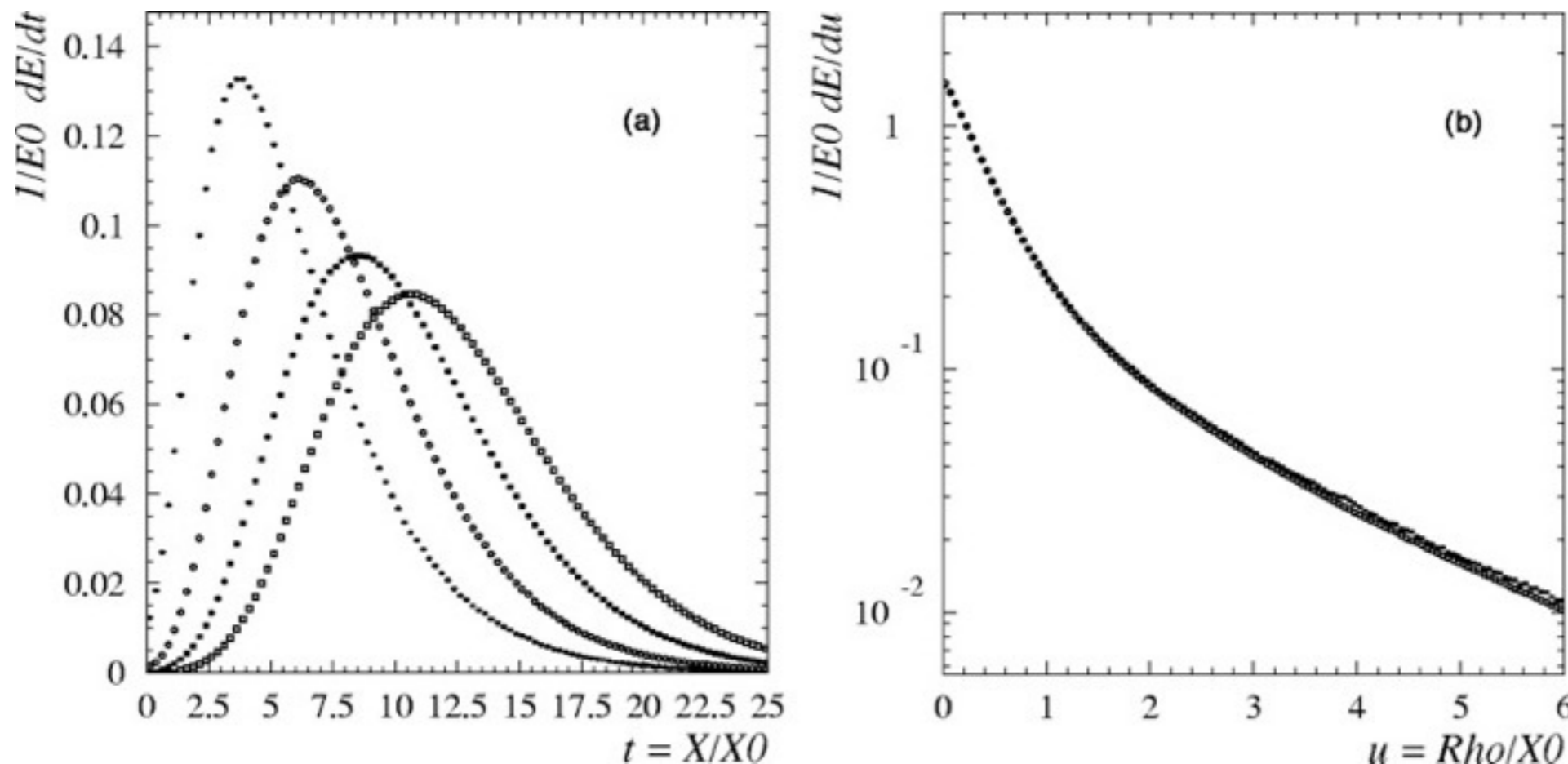

Characteristic Parameters of Showers - Hadronic

- The length scale of hadronic showers is given by the **nuclear interaction length λ_I** (mean free path between hadronic interactions)

$\lambda_I > X_0$ for all materials with $Z > 4$

	λ_I	X_0
Polystyrene	81.7 cm	43.8 cm
PbWO	20.2 cm	0.9 cm
Fe	16.7 cm	1.8 cm
W	9.9 cm	0.35 cm

Hadronic showers are complicated:

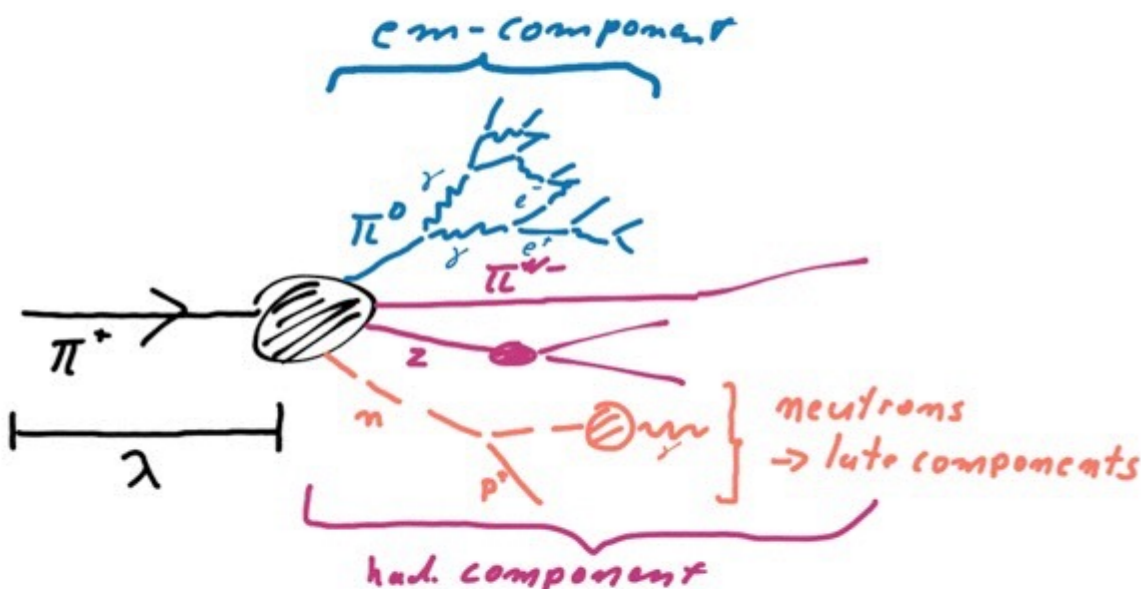

- Relativistic hadrons created in interactions with nuclei, carry a sizeable fraction of momentum of original particle [0 GeV]
- About 1/3 of all pions created are π^0 : instantaneous decay to photons, em subshower
- Neutrons created in evaporation/spallation, photons from neutron capture \rightarrow MeV (or lower)
- Energy loss due to binding energy, ...

Homogeneous ECAL: Anorganic Crystals

- Hohe Reinheit: Gute Transmission des Szintillationslichts
- Hohe Dichte: Bestimmt die Tiefe des Kalorimeters

Example: CMS ECAL

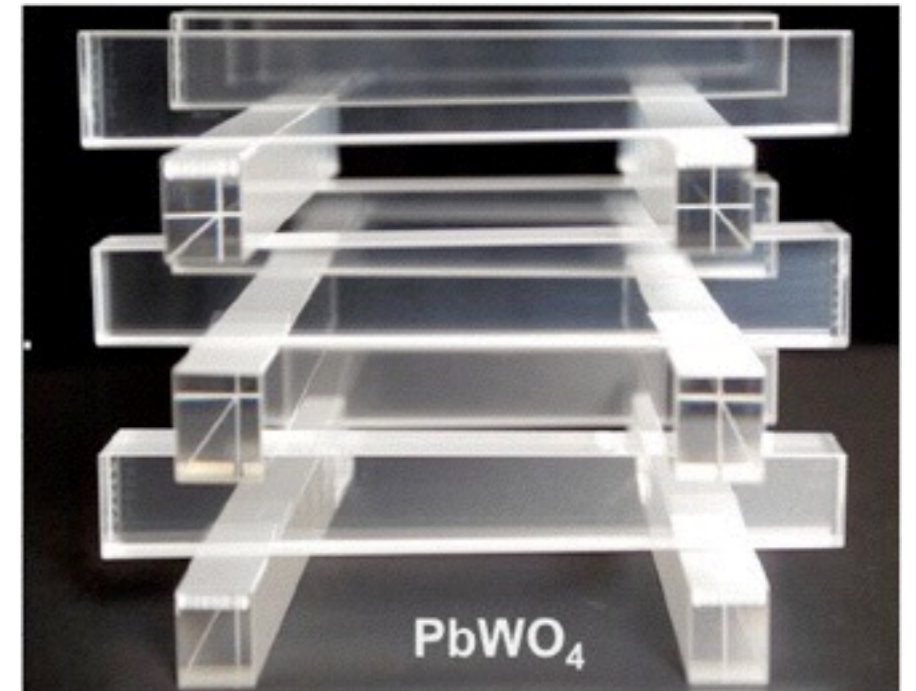
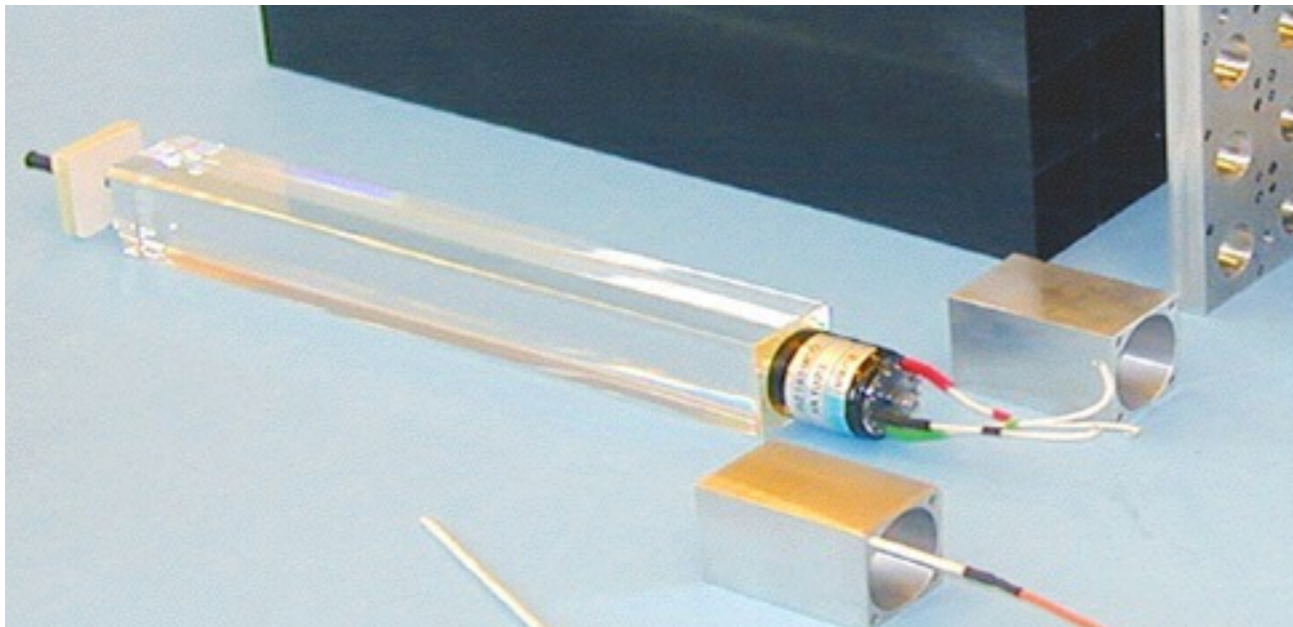

- PbWO_4 : Fast, high-density scintillator
 - Density $\sim 8.3 \text{ g/cm}^3$ (!)
 - ρ_M 2.2 cm, X_0 0.89 cm
 - low light yield: ~ 100 photons / MeV, temperature dependent: $-2\%/^\circ\text{C}$

Sampling Calorimeter: STAR ECAL

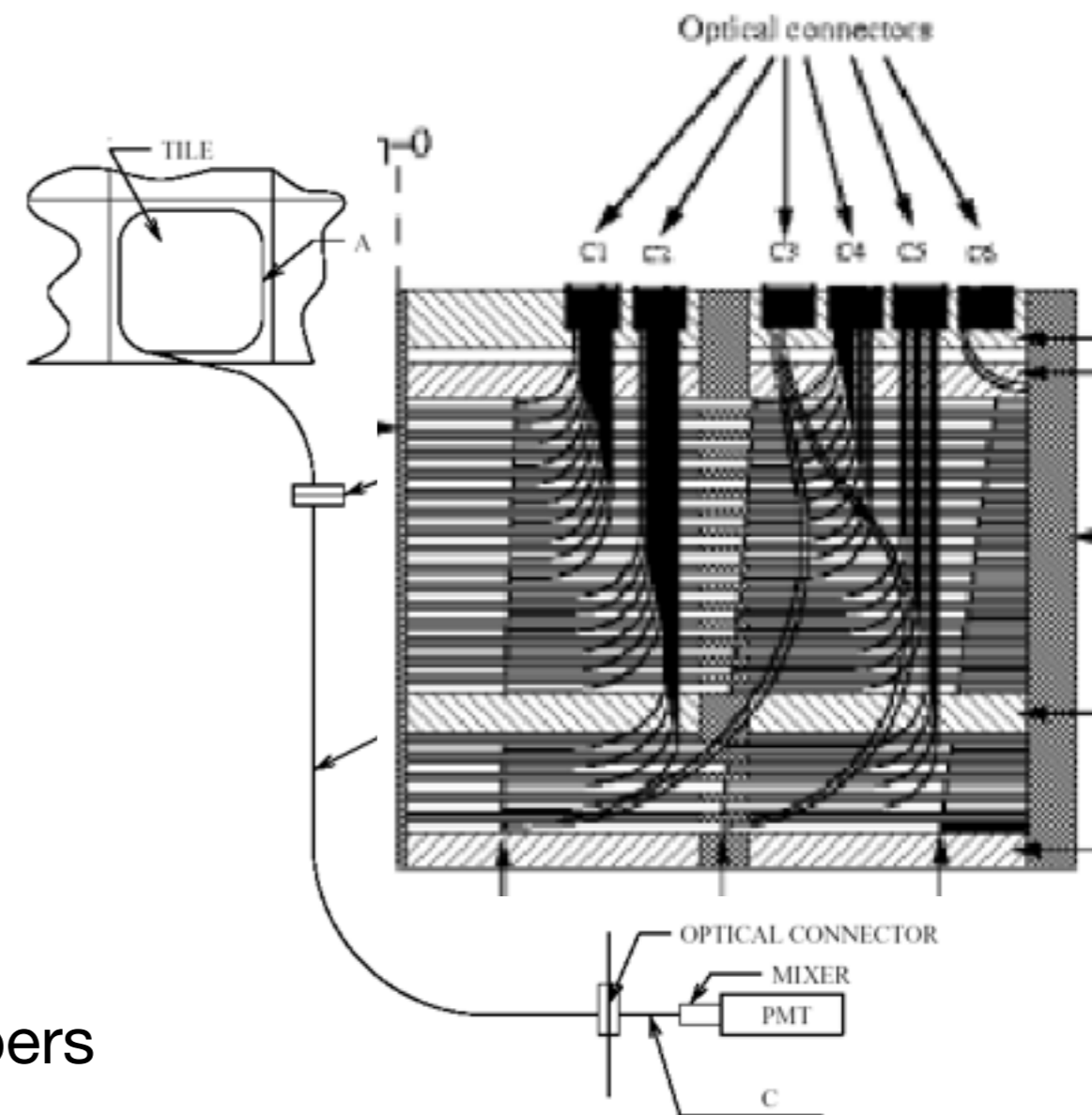
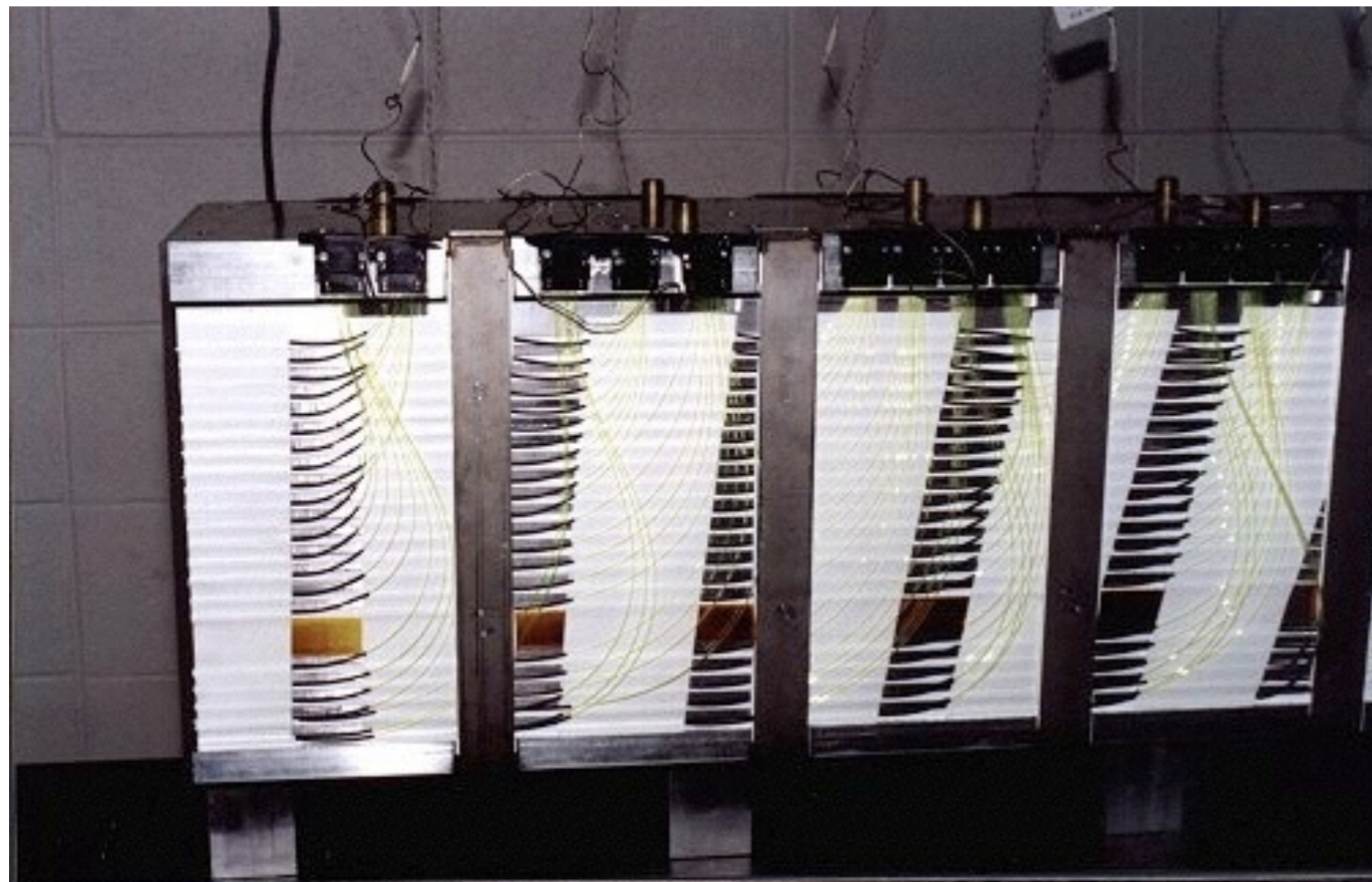

- Plastic scintillator plates between lead absorbers
- The light is collected in each plate by wavelength-shifting fibers
- The fibers guide the light outside of the magnetic field, where it is concentrated per “tower” and read out with a PMT

Homogeneous vs Sampling: Resolution!

Neutral pions

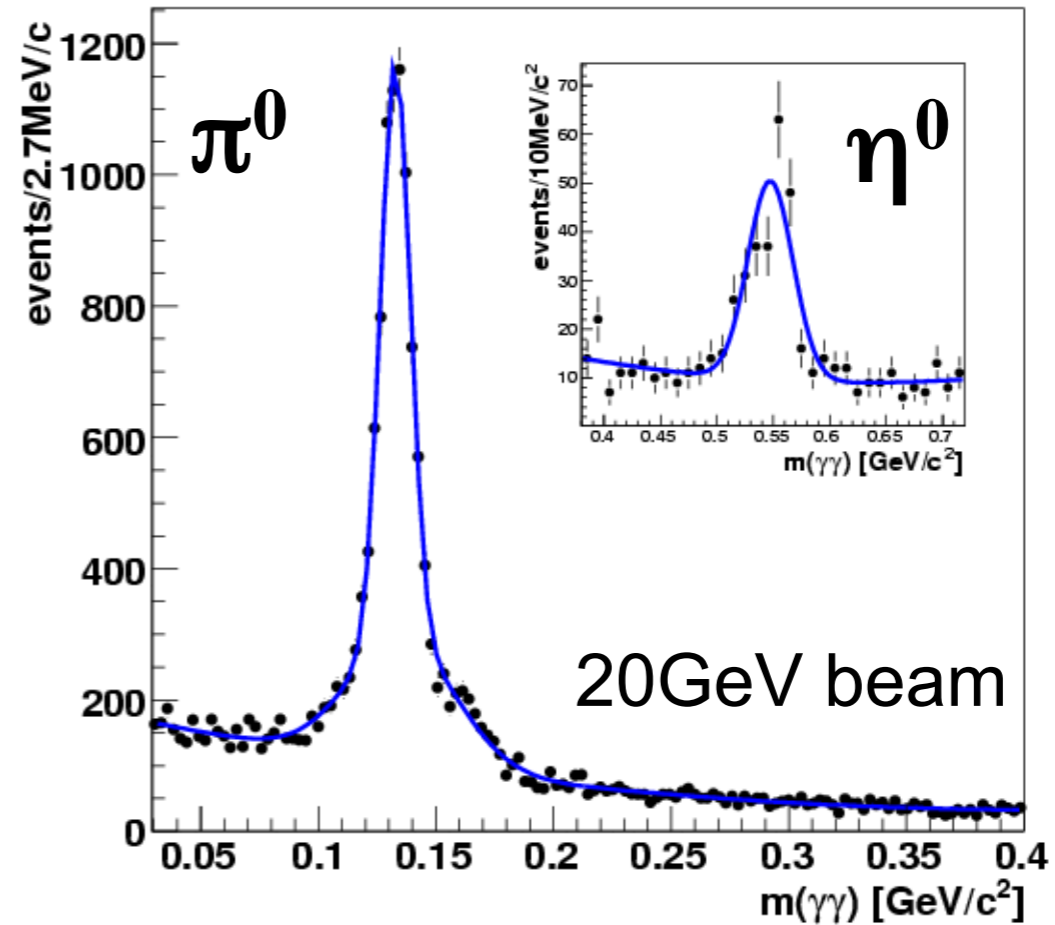
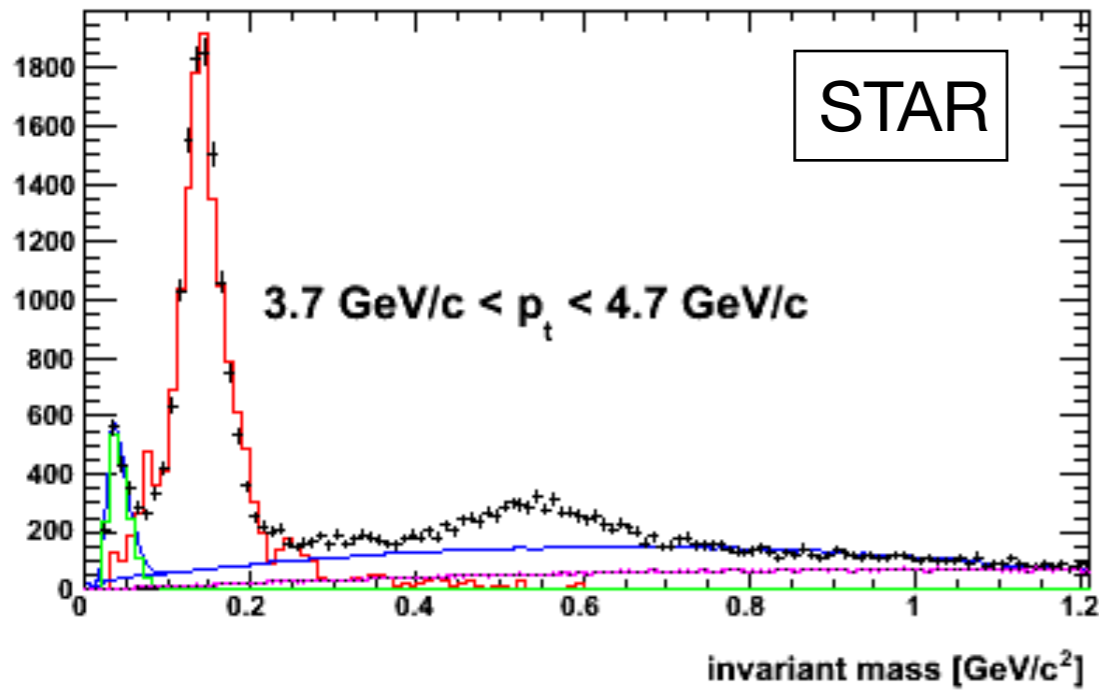

CMS

- Stochastic Term:
 - STAR: $\sim 14\%$
 - CMS: 2.8%

Homogeneous vs Sampling: Resolution!

Neutral pions

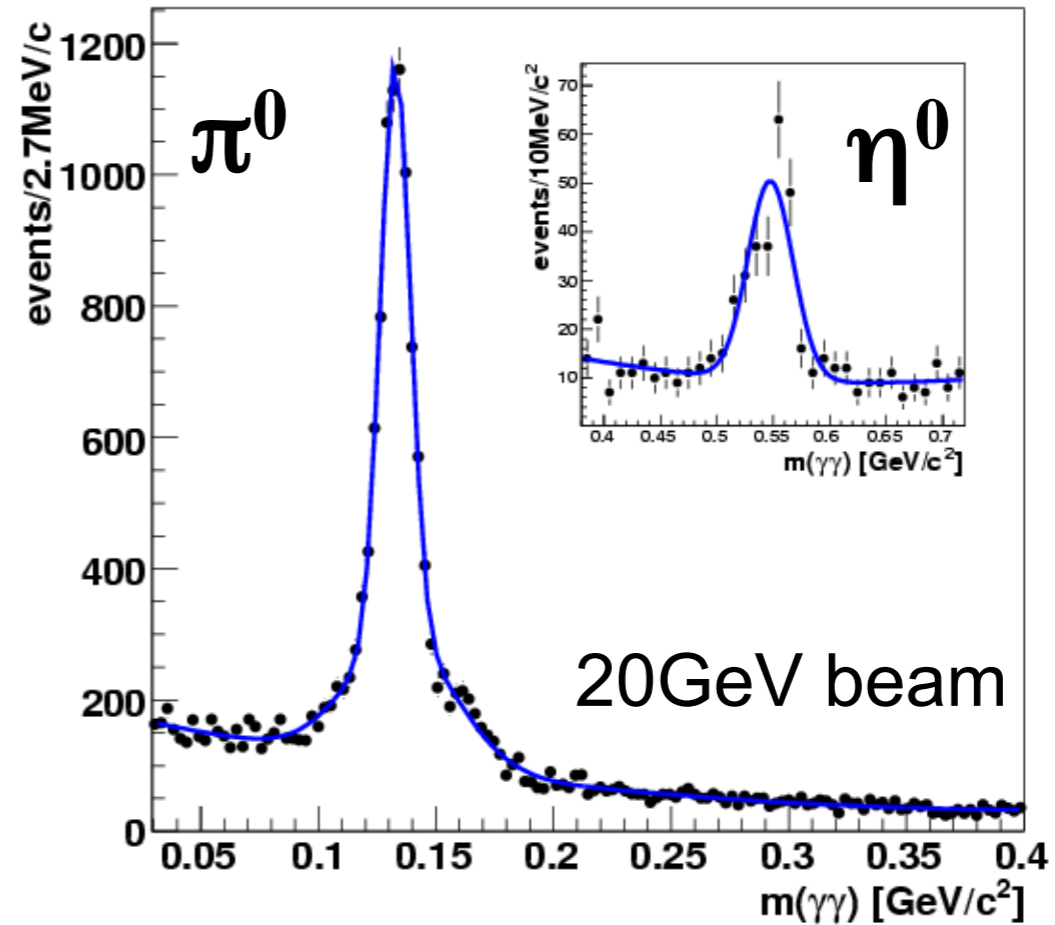
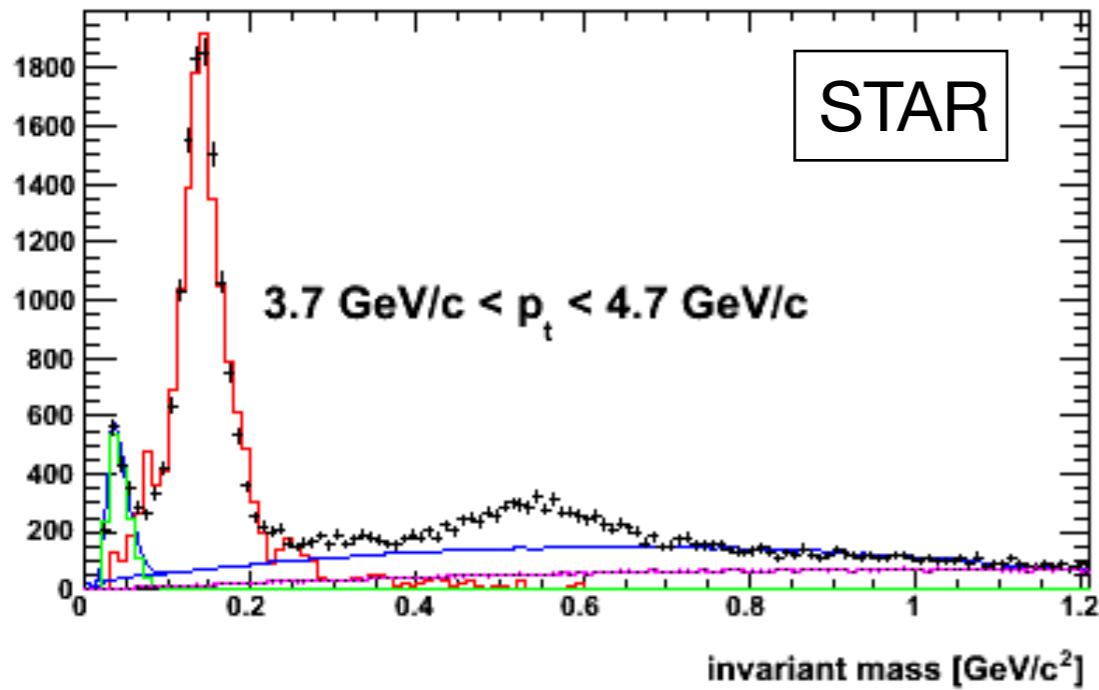

- Stochastic Term:
 - STAR: $\sim 14\%$
 - CMS: 2.8%

But:

Crystals are very expensive!

And: In combination with hadron calorimeters they provide often a very poor hadronic energy resolution

Alternative Technology: ATLAS Liquid Argon

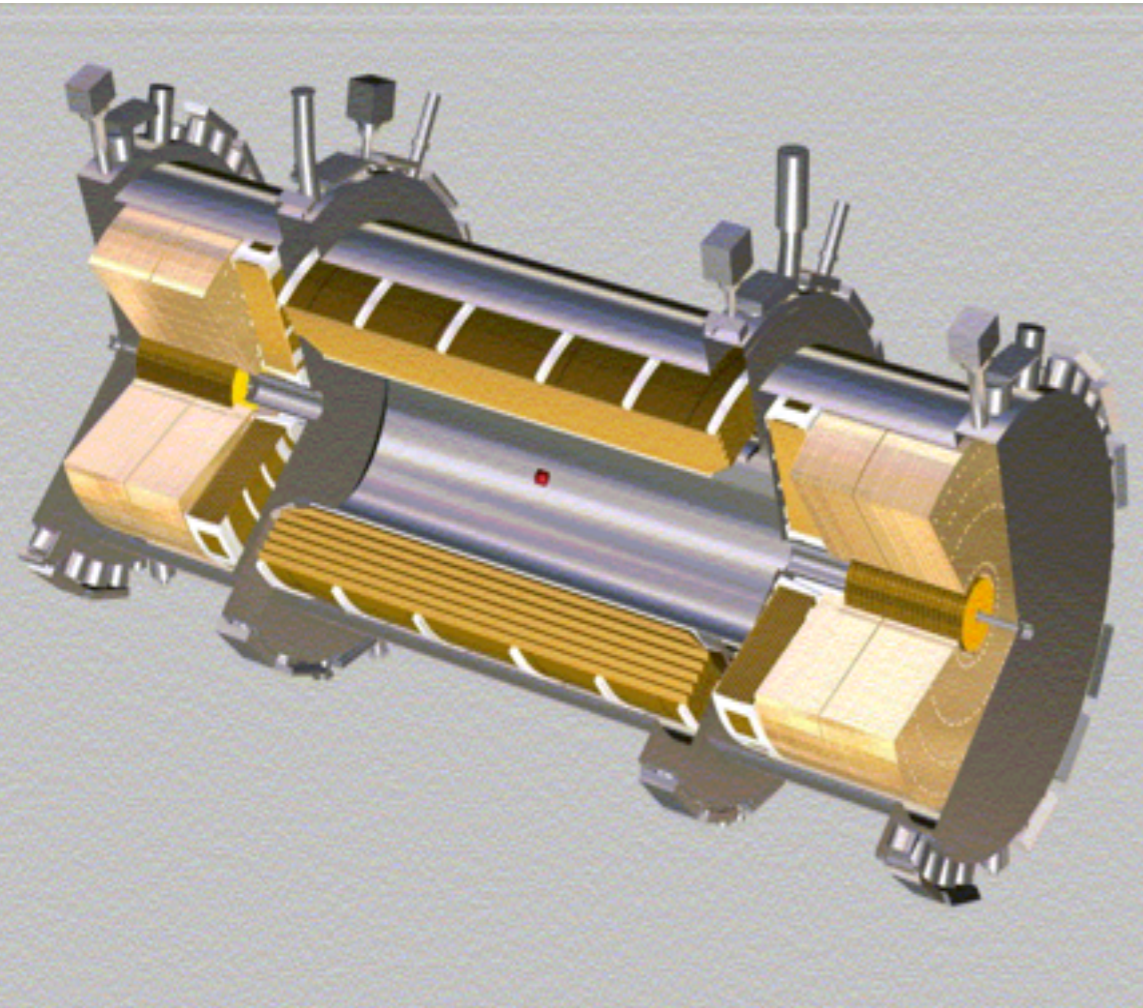

- Barrel EMC
 - (The ATLAS barrel HCAL uses steel + plastic scintillator)
- Endcap - EMC and HCAL
- ECAL: Pb-LAr, with “accordion geometry”

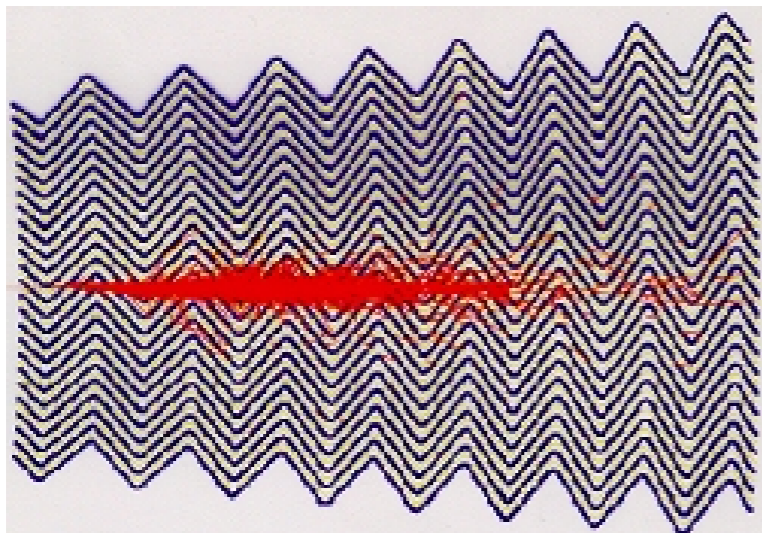

LAr Calorimeters

- LAr: Density 1.4 g/cm^3 , X_0 14 cm
 - ▶ relatively high sampling fraction
- Charge is produced by through-going particles
- Charge collection on electrons (no amplification!)
- high purity of cryogenic liquid required - but then (with constant filtering) the active medium is indestructible also by high radiation levels
- accordion geometry simplifies readout, minimizes drift length and thus allows high rates

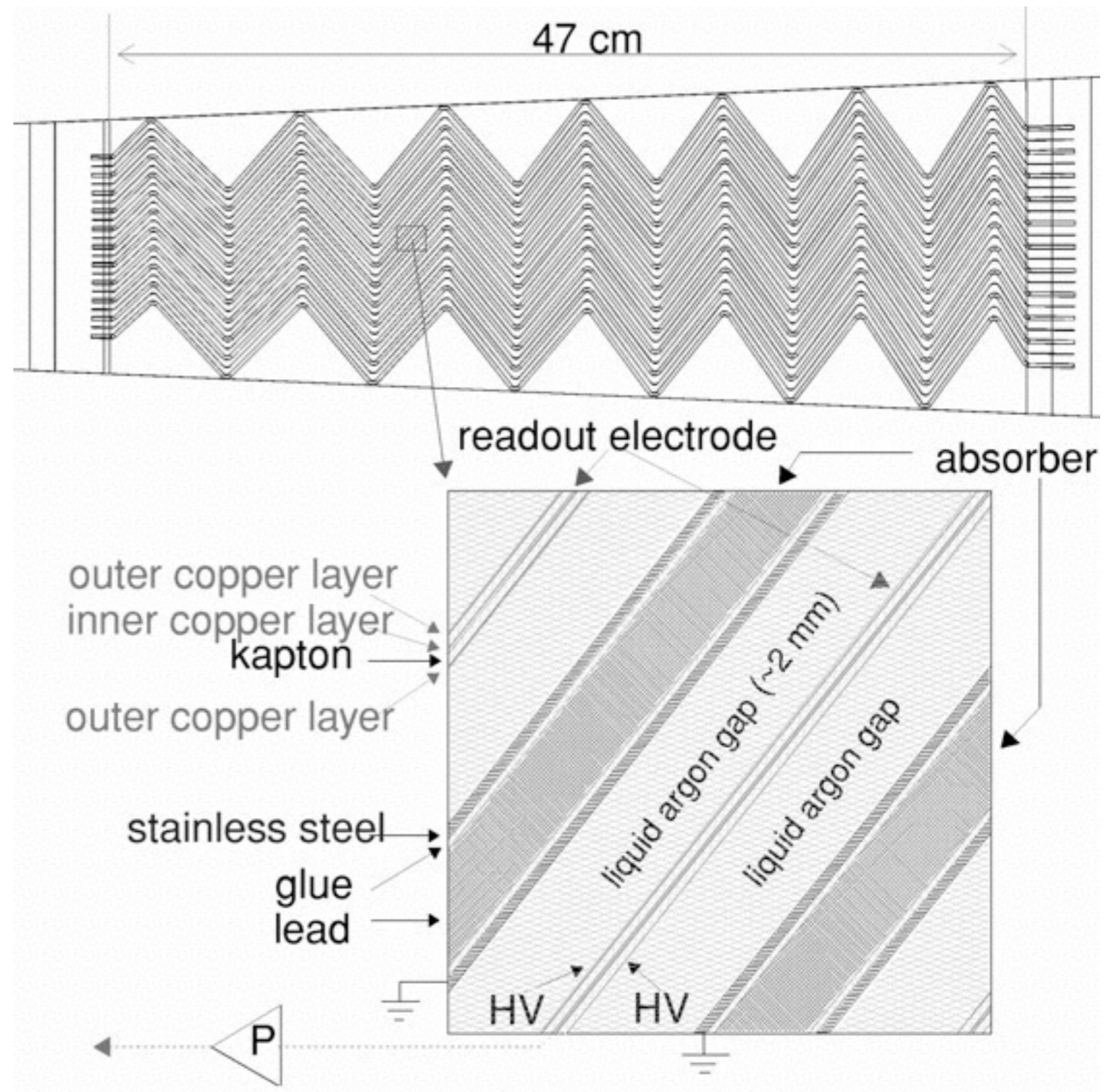

Resolution of Hadronic Calorimeters

- The general considerations for calorimeters apply also here
 - stochastic, constant and noise term
- but: Typically the detector responds differently to pure hadronic sub-showers and electromagnetic components (due to different length scale of interactions and “invisible” losses in hadronic reactions): $e/\pi > 1$
- Fluctuations of electromagnetic fraction deteriorate resolution and result in non-linearities: deviations from expected $1/\sqrt{E}$ behavior

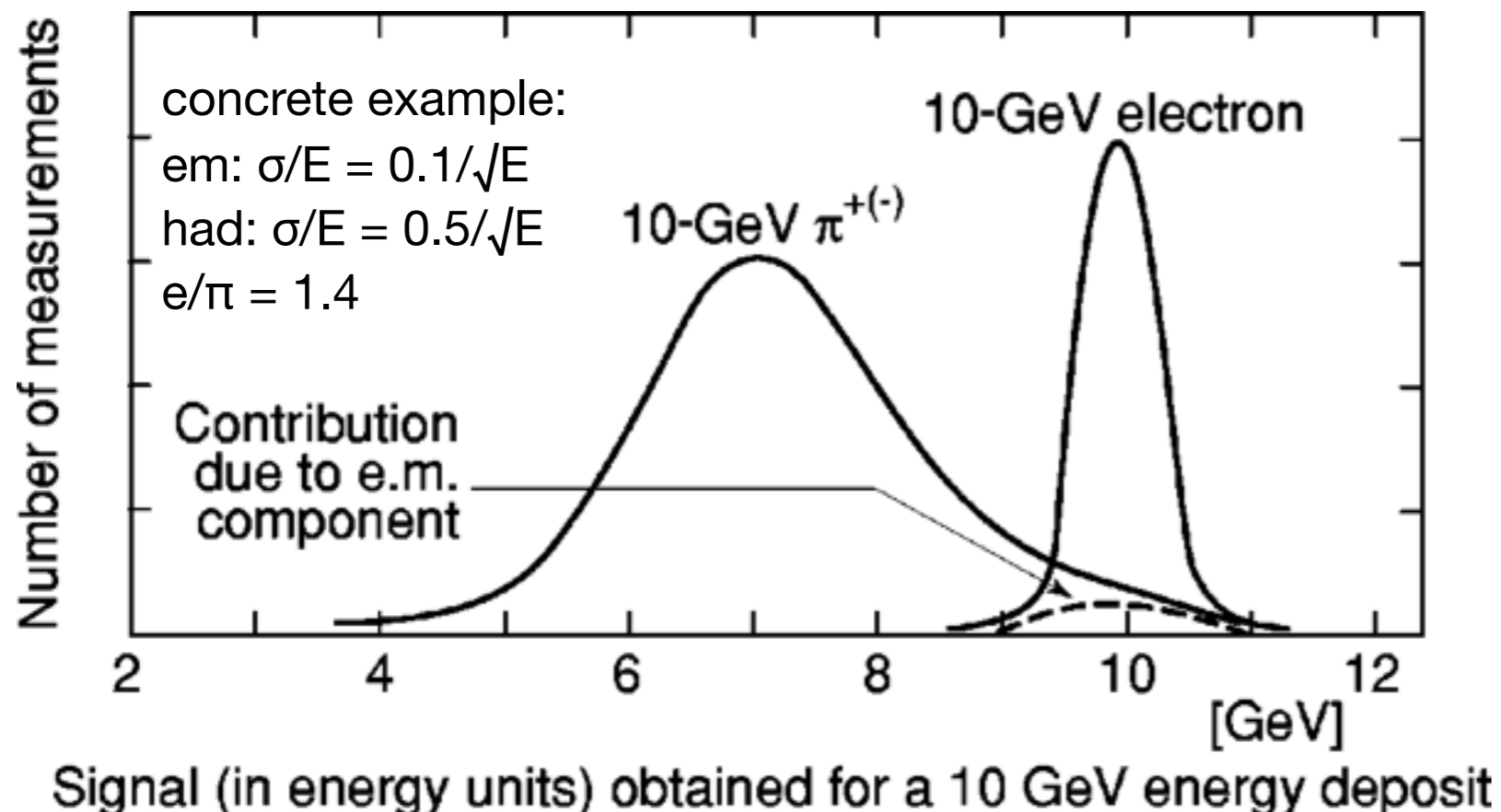

C. Fabjan, F. Gianotti, Rev. Mod. Phys. 75, 1243 (2003)

Resolution of Hadronic Calorimeters

- The general considerations for calorimeters apply also here
 - stochastic, constant and noise term
- but: Typically the detector responds differently to pure hadronic sub-showers and electromagnetic components (due to different length scale of interactions and “invisible” losses in hadronic reactions): $e/\pi > 1$
- Fluctuations of electromagnetic fraction deteriorate resolution and result in non-linearities: deviations from expected $1/\sqrt{E}$ behavior

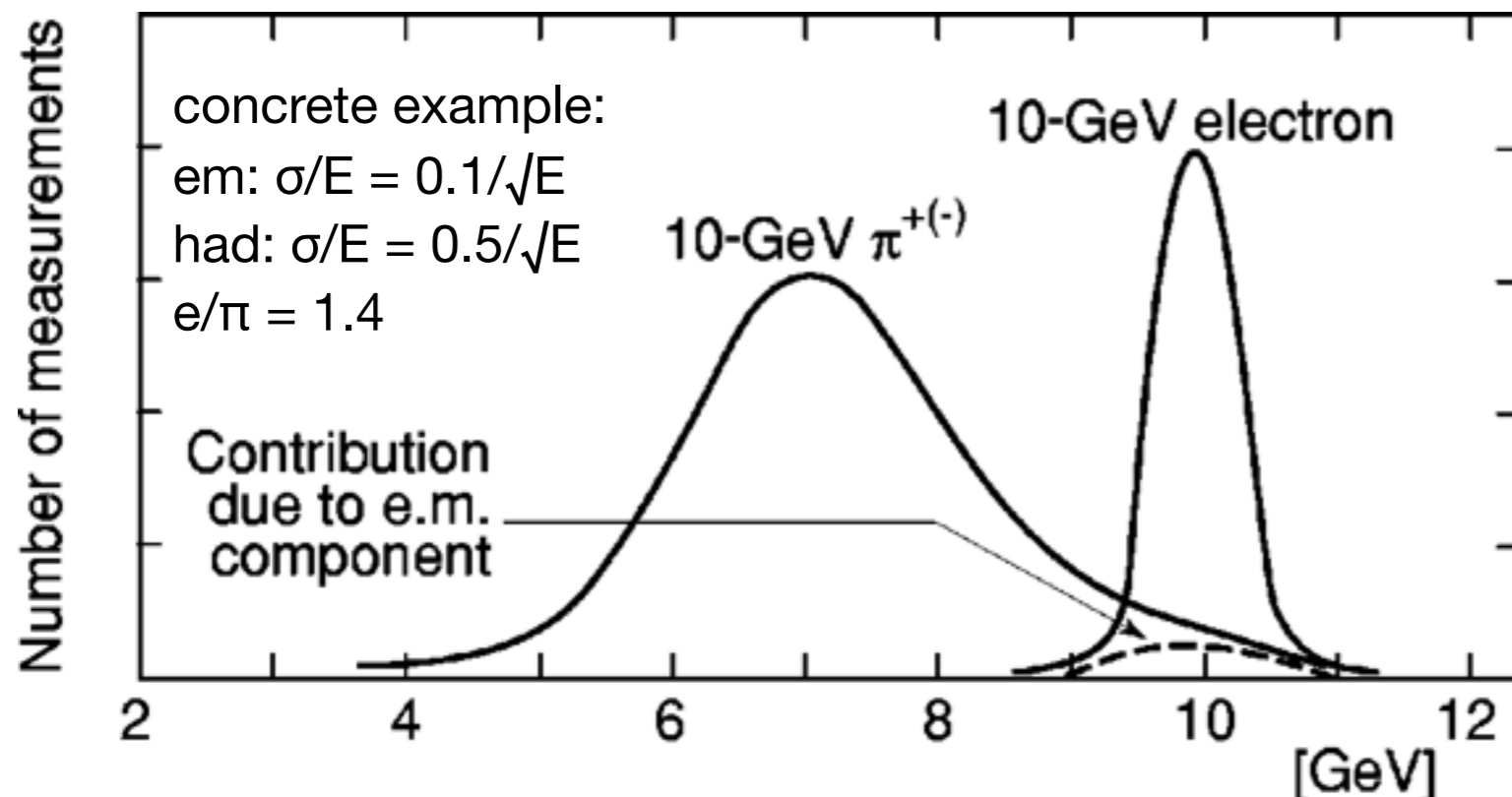

Signal (in energy units) obtained for a 10 GeV energy deposit

can be fixed with
“compensating calorimeters”
 $e/\pi = 1$ - But requires very
specific geometries, for best
results the use of Uranium
absorbers and provides rather
poor electromagnetic
performance

ATLAS Barrel HCAL

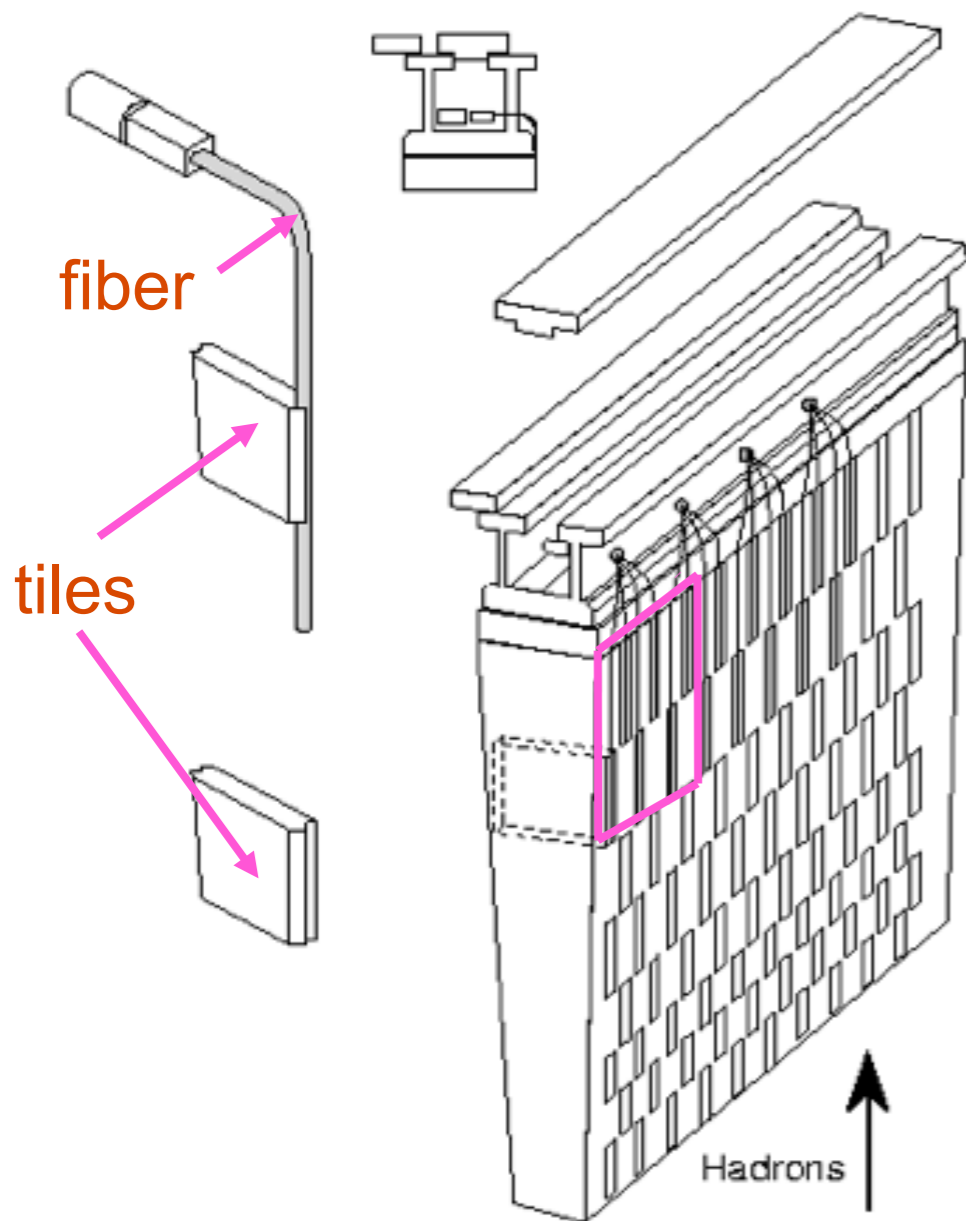

- Stainless steel / scintillator
- Scintillator cells parallel to particle incidence - works since most particles are low energy and travel at larger angles
- Readout with two fibers per tile
- 3 longitudinal segments, fibers are bundled for each segment and read out with a PMT outside magnet

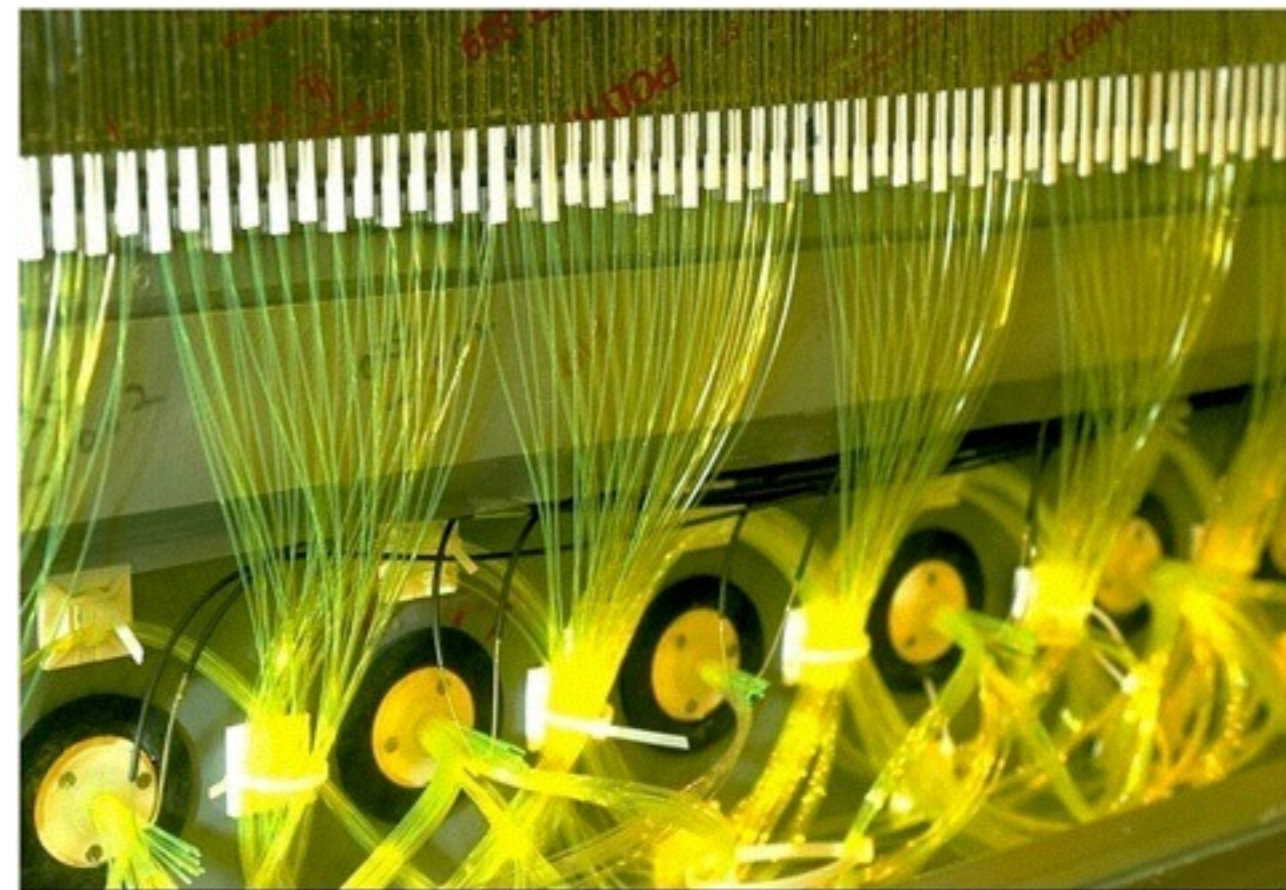

Global Performance for Hadrons - CMS

- A state of the art system: CMS

- A fantastic ECAL - PbWO_4 crystals with APD readout
- EM energy resolution $\sim 2.8\%/\sqrt{E}$
- The price to pay: Single hadron stochastic term $\sim 93\%$

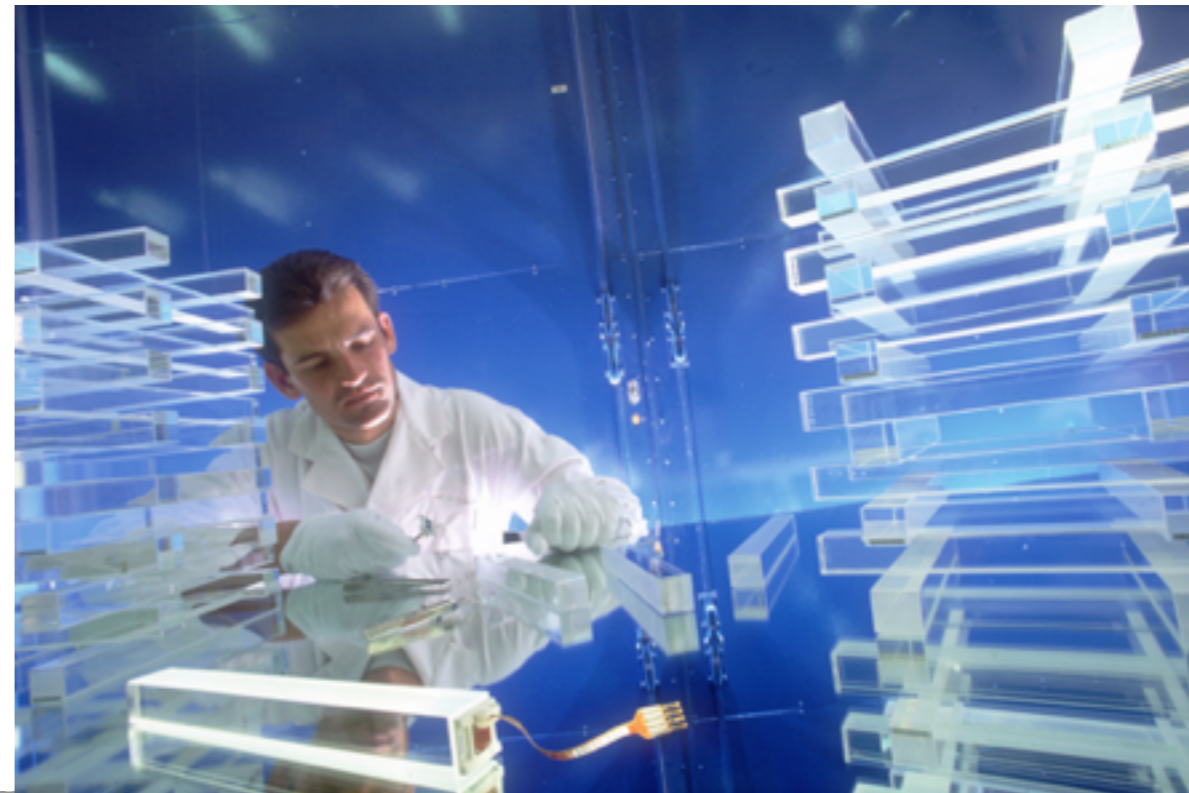
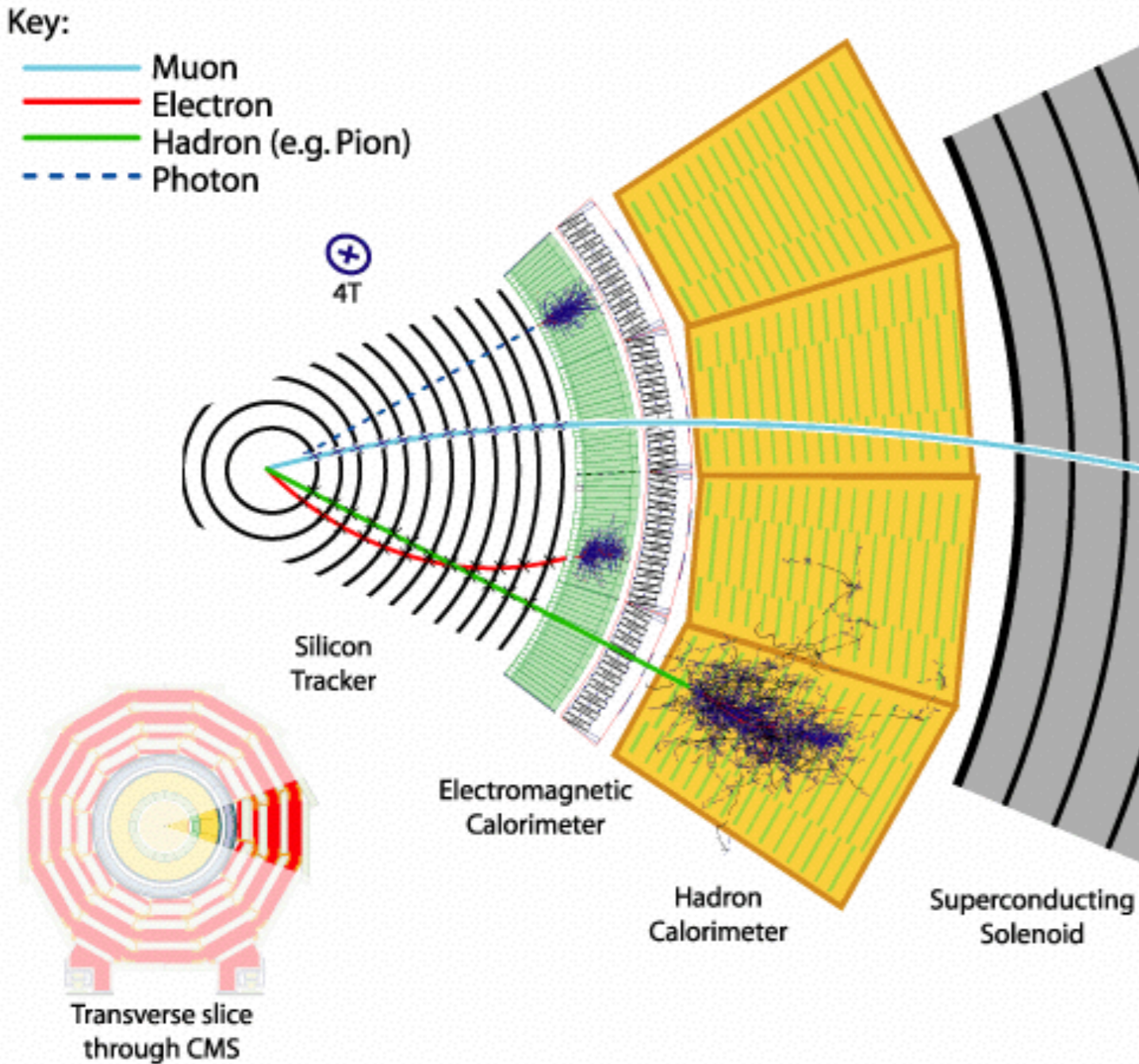

Global Performance for Hadrons - ATLAS

- A state of the art system: ATLAS

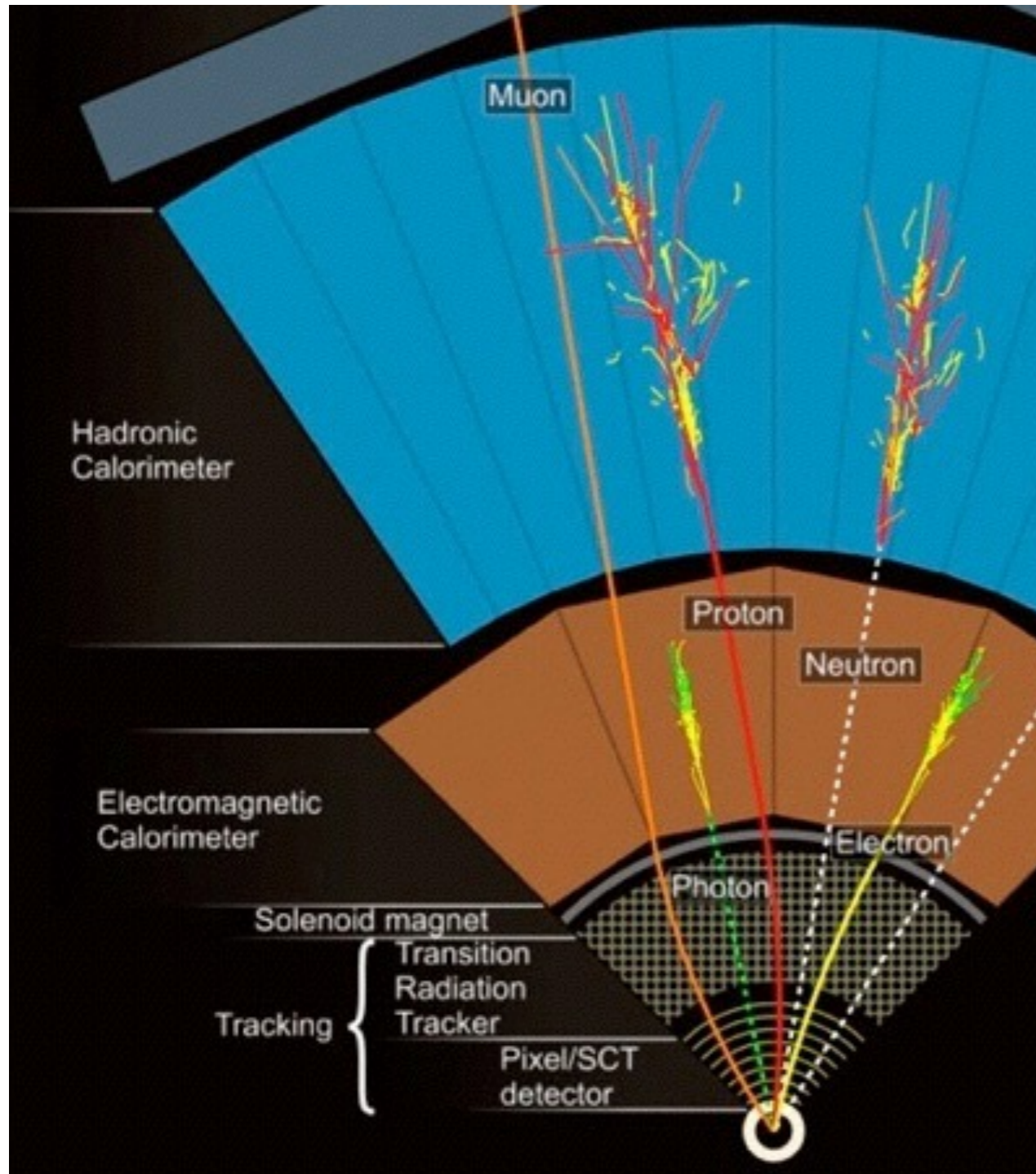

- LAr ECAL, Scintillator HCAL in Barrel both longitudinally segmented
 - EM resolution $\sim 9\%/\sqrt{E}$
 - Single hadron stochastic term $\sim 42\%$ (with software “compensation” making use of segmentation)



Important Measurement: Missing Energy

- Is used to reconstruct “invisible” particles
 - Neutrinos, for example in the decay of W bosons
 - New particles, for example possible dark matter particles
- ▶ An indispensable tool to search for New Physics
- ▶ Calorimeter measure the energy of all particles (except muons) - The most crucial system for total energy measurements

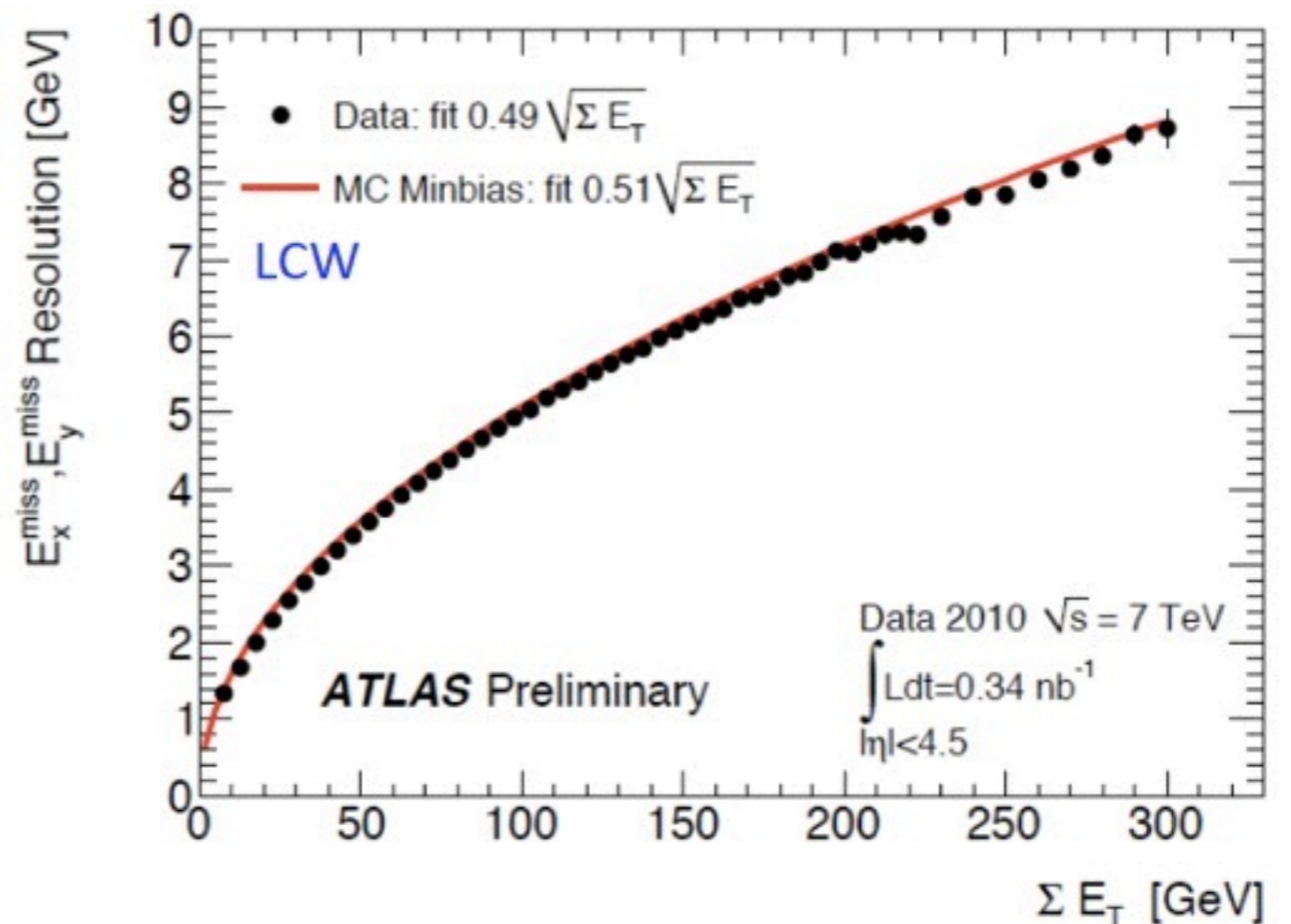
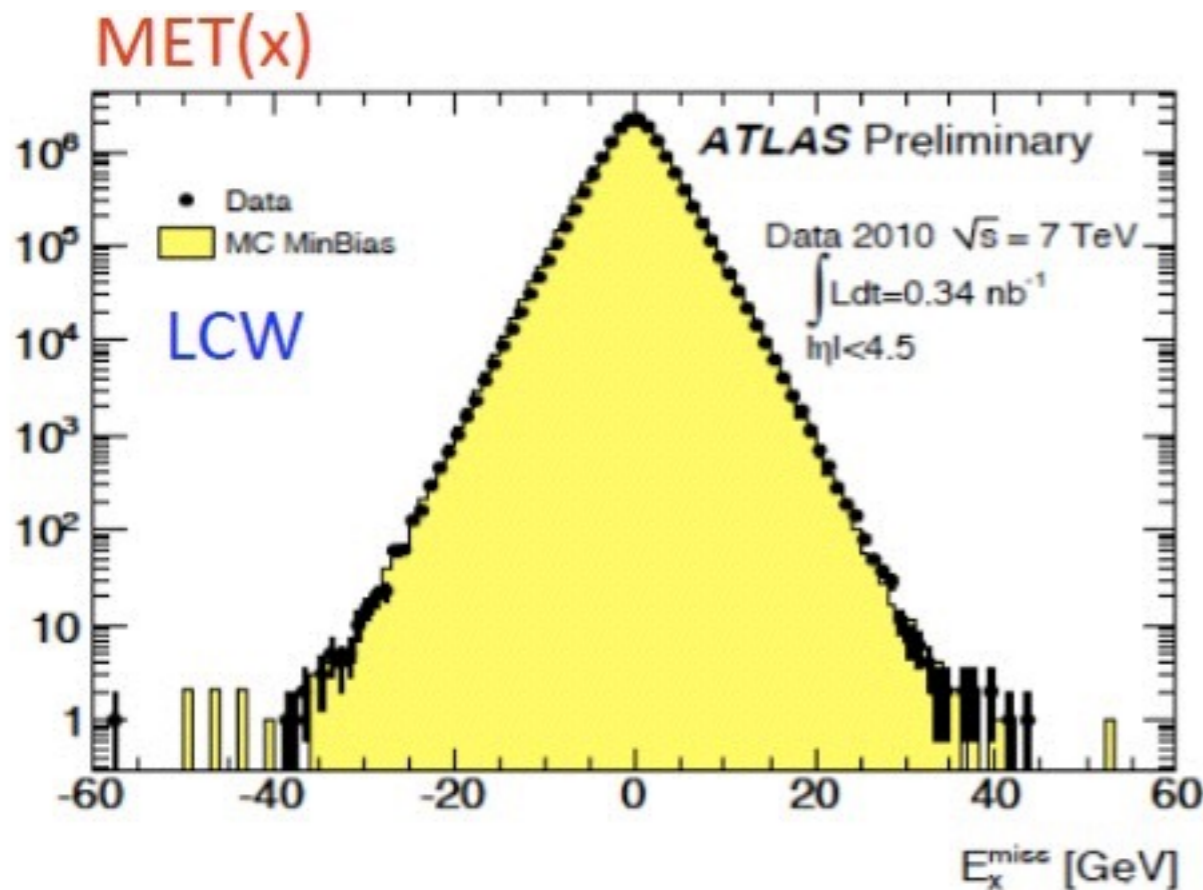

SiPMs - Revolutionizing Calorimetry

- A quantum leap forward - replacing the PMT:
 - High gain -> Fast electronics no problem
 - Small size, low cost -> High channel counts possible (up to 10s of millions in HEP)
 - Insensitivity to B-Fields: Photon detectors in magnetic field

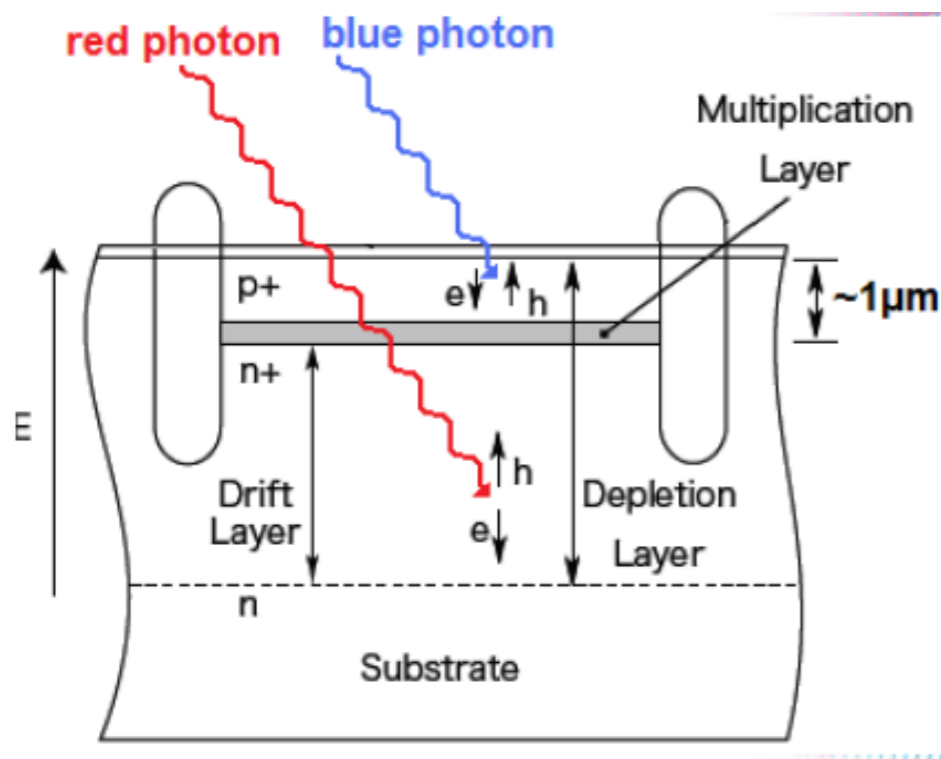

SiPM from MEPHI / PULSAR

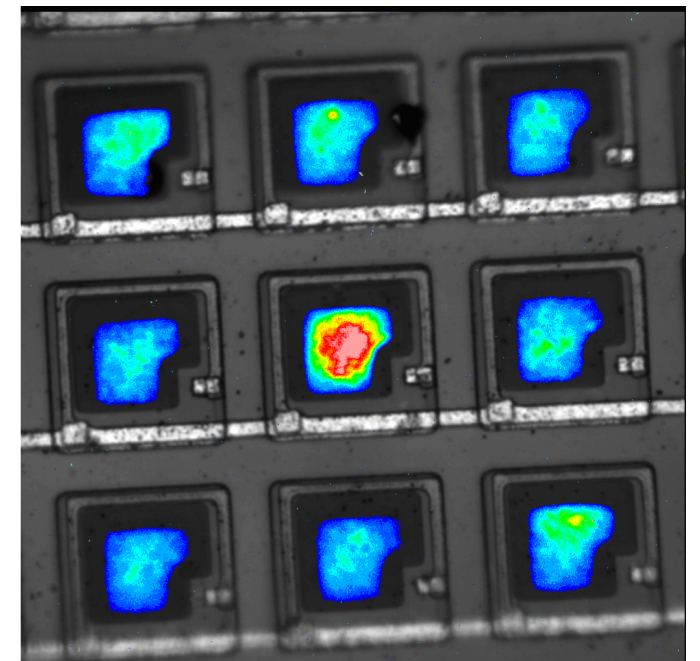
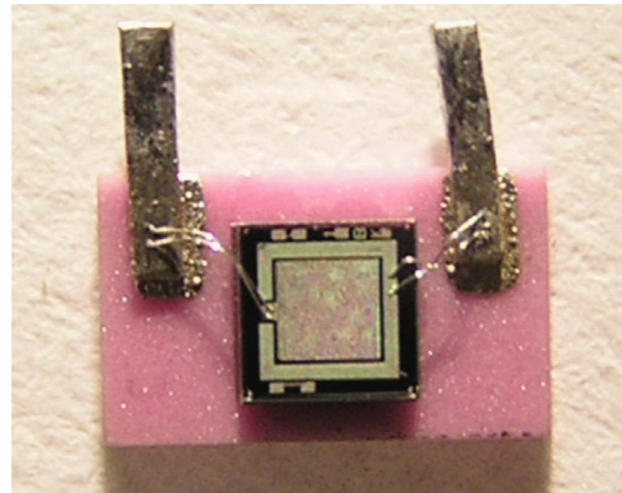

- The first large-scale use of these devices: The CALICE analog HCAL, a physics prototype for Linear Collider detectors -> almost 8k channels (SiPMs)

Particle Flow - Jets from Individual Particles

- Improve jet energy reconstruction by measuring each particle in the jet with best possible precision
 - Measure all charged particles in the tracker (remember, 60% charged hadrons!)
 - ▶ Significantly reduce the impact of hadron calorimeter performance: Only for neutral hadrons
 - ▶ Measure only 10% of the jet energy with the HCAL, the “weakest” detector: significant improvement in resolution

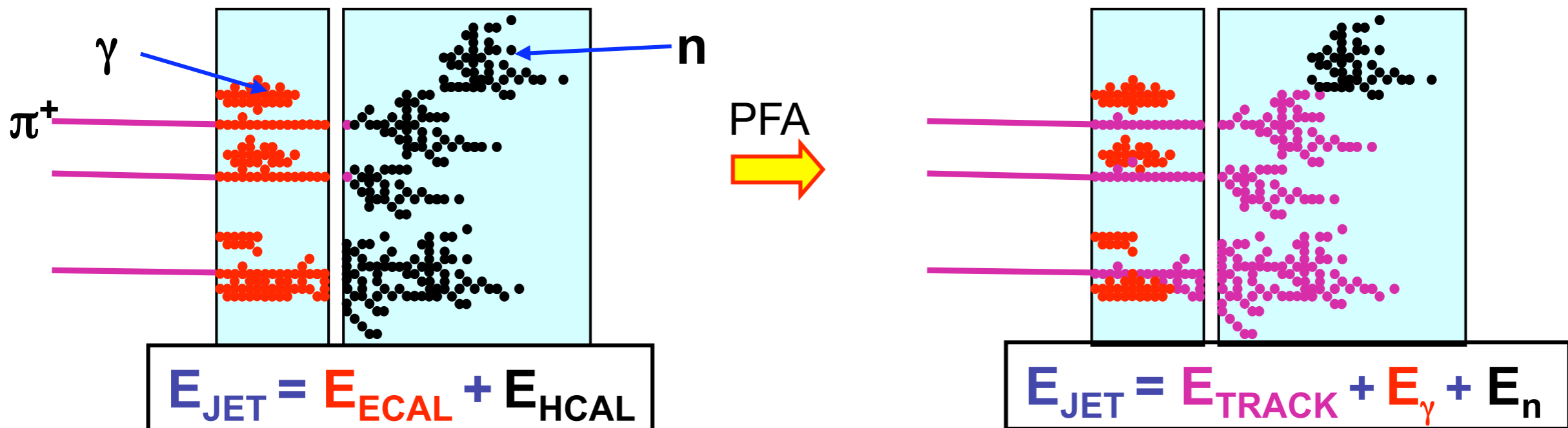

Imaging Calorimeters: Making PFA Happen

- For best results: High granularity in 3D - Separation of individual particle showers
 - Granularity more important than energy resolution!
- Lateral granularity below Moliere radius in ECAL & HCAL
- In particular in the ECAL: Small Moliere radius to provide good two-shower separation - Tungsten absorbers
 - Highest possible density: Silicon active elements - Thin scintillators also a possibility
- And: Sophisticated software!

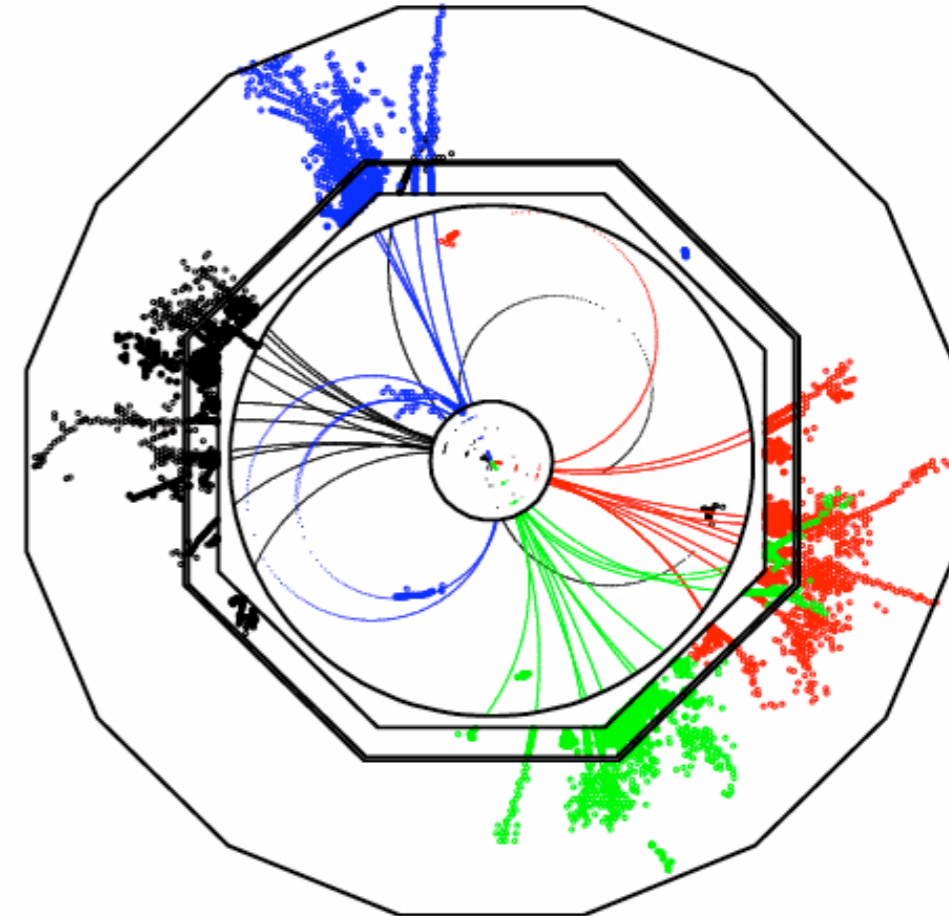

Imaging Calorimeters: Making PFA Happen

- For best results: High granularity in 3D - Separation of individual particle showers
 - ▶ Granularity more important than energy resolution!
- Lateral granularity below Moliere radius in ECAL & HCAL
- In particular in the ECAL: Small Moliere radius to provide good two-shower separation - Tungsten absorbers
 - Highest possible density: Silicon active elements - Thin scintillators also a possibility
- And: Sophisticated software!

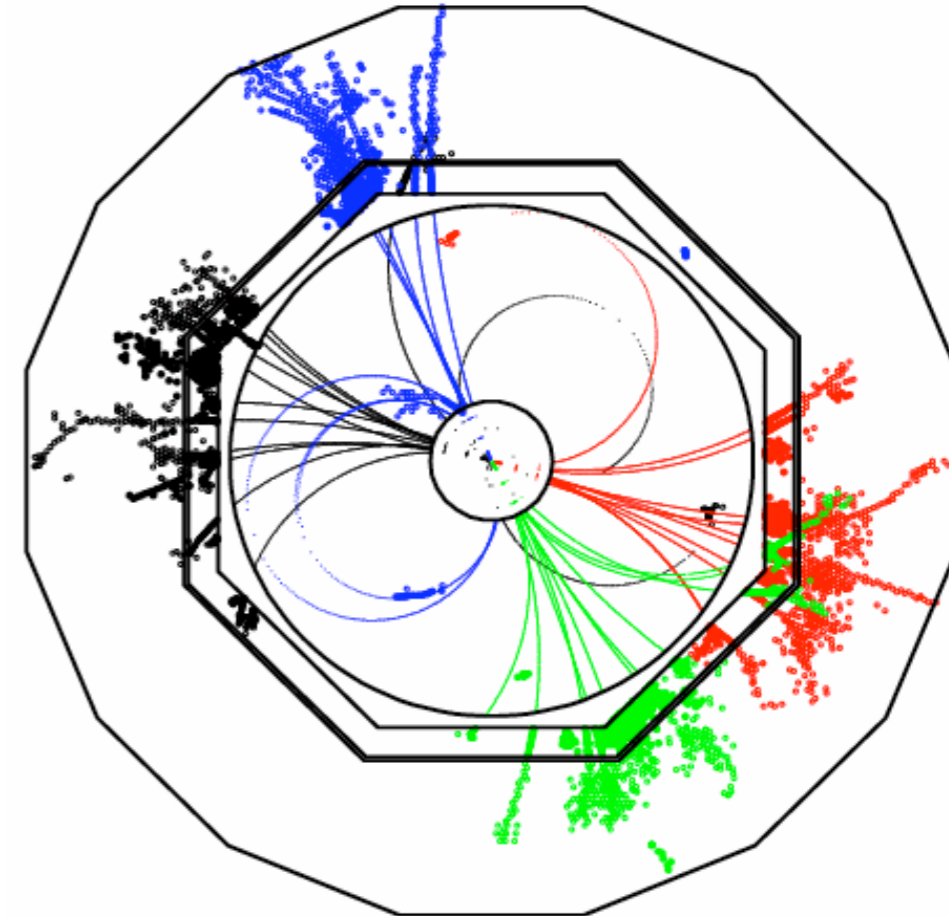

Extensively developed & studied for Linear Collider Detectors: Jet energy resolution goals (3% - 4% or better for energies from 45 GeV to 500 GeV) can be met

PFA - Not Just a Crazy Idea

- Successfully used in CMS - A granular detector (but far less so than linear collider detectors)

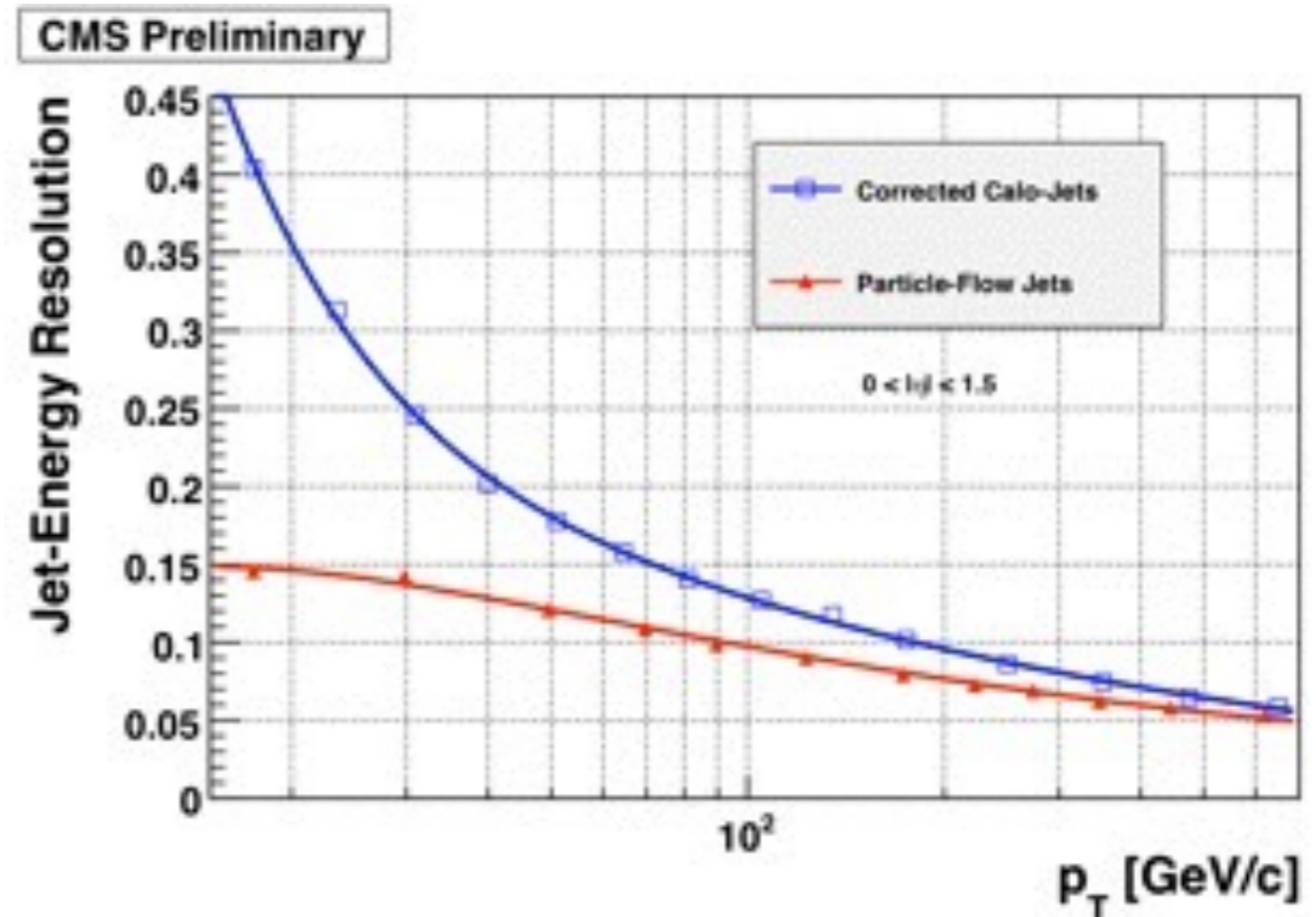
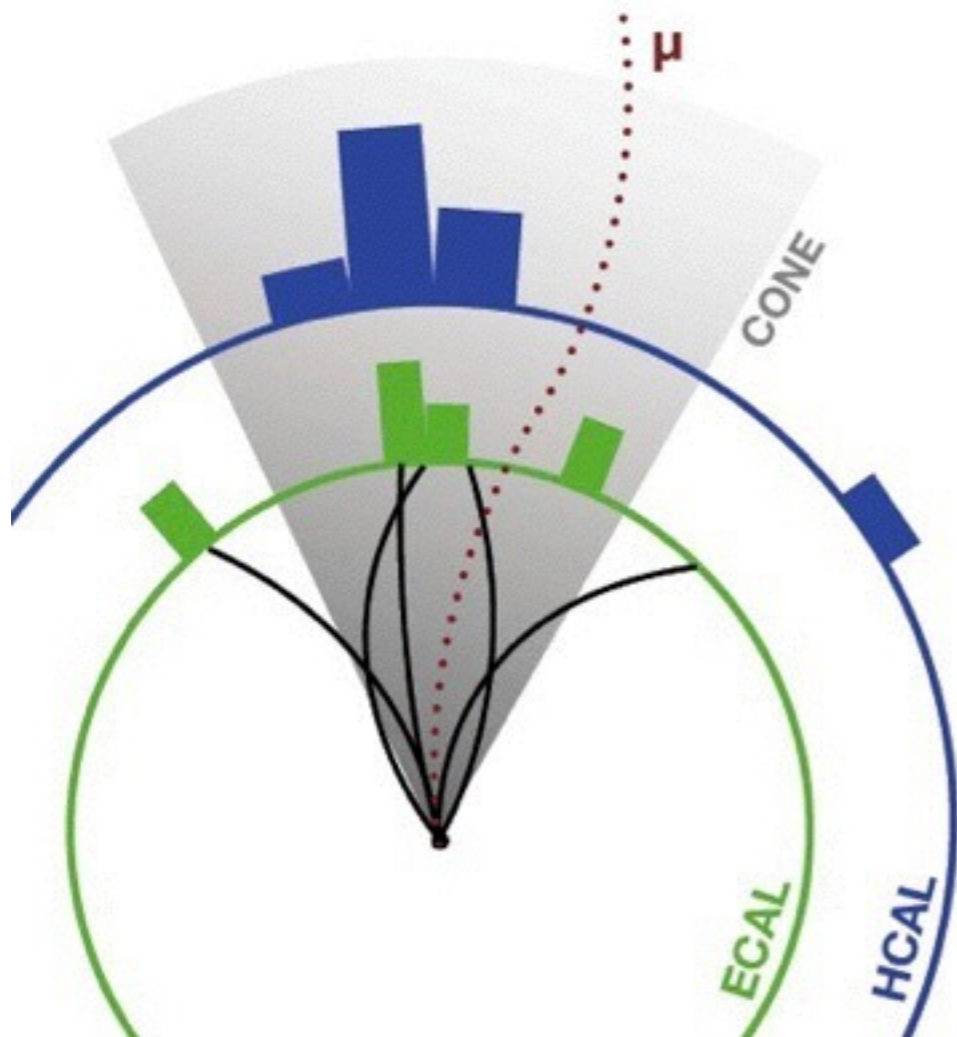

- Resolution improved by up to a factor of 3 at low energy

High Granularity with SiPMs

- PFA calorimeters developed by the CALICE collaboration - Various different technologies
 - ECALs with W absorber, Si & Scintillator + SiPM readout
 - HCALs with Steel and W absorber, Scintillator + SiPM & Gas detector readout

One of the technology highlights: The first large-scale use of SiPMs in the CALICE analog HCAL

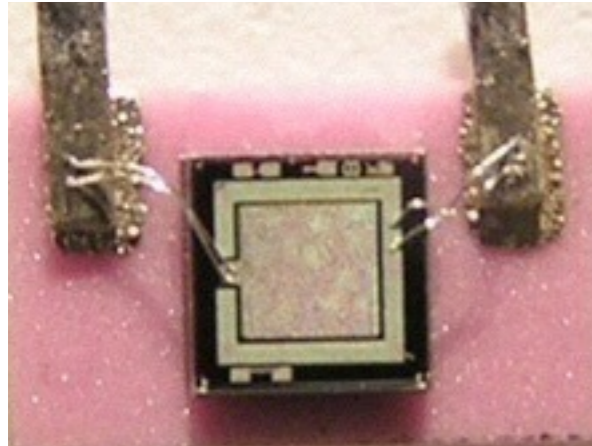

Plastic scintillator tiles with WLS fiber & SiPM

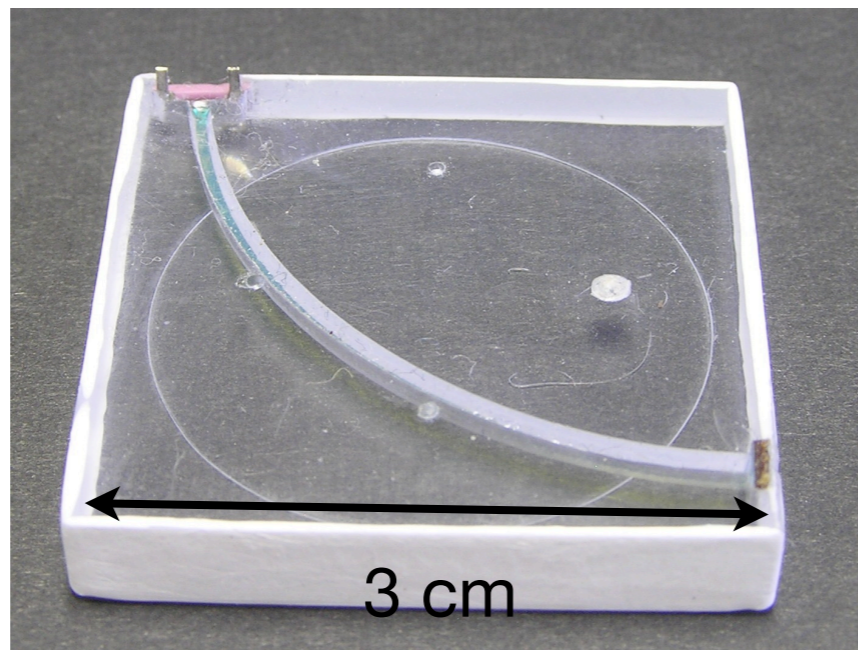

SiPM: 1156 pixels, manufactured by MePhI/PULSAR

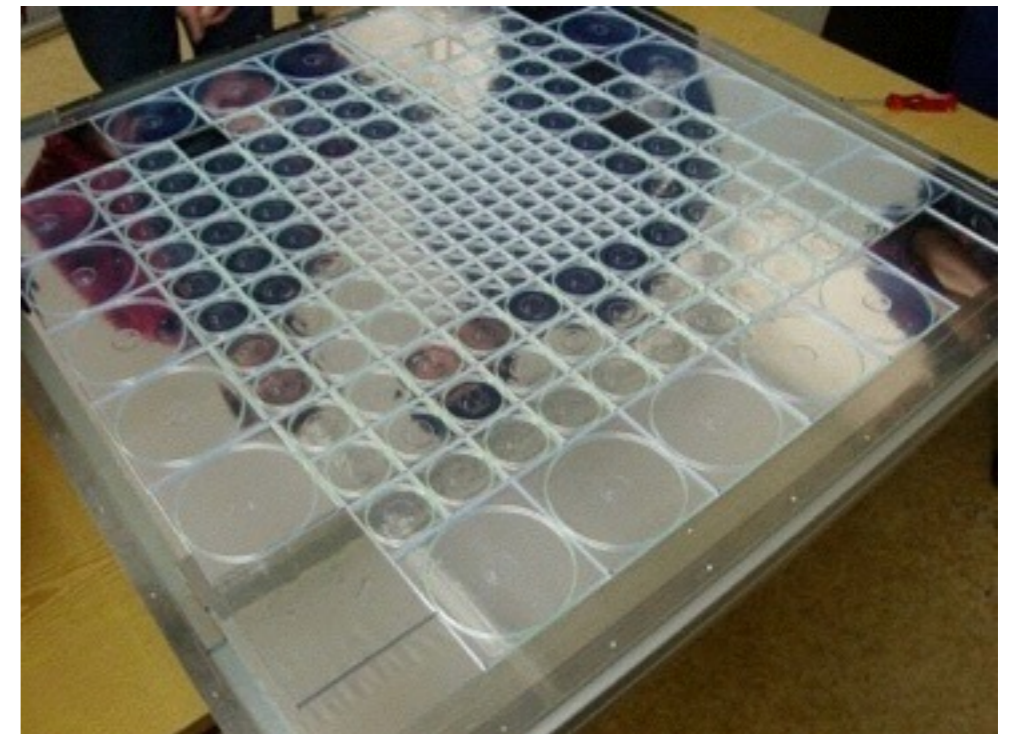

212 scintillator tiles per layer, 38 layers, each channel read out separately

8 000 channels in total

Imaging HCAL with SiPMs - Performance

- Looking deep into showers

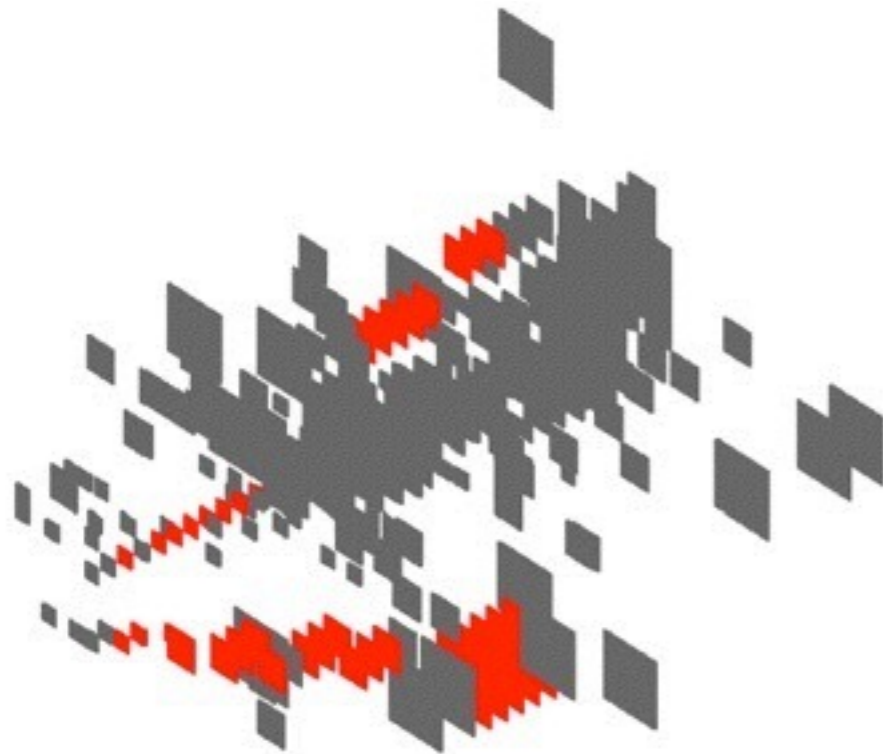

- Reconstructing energy

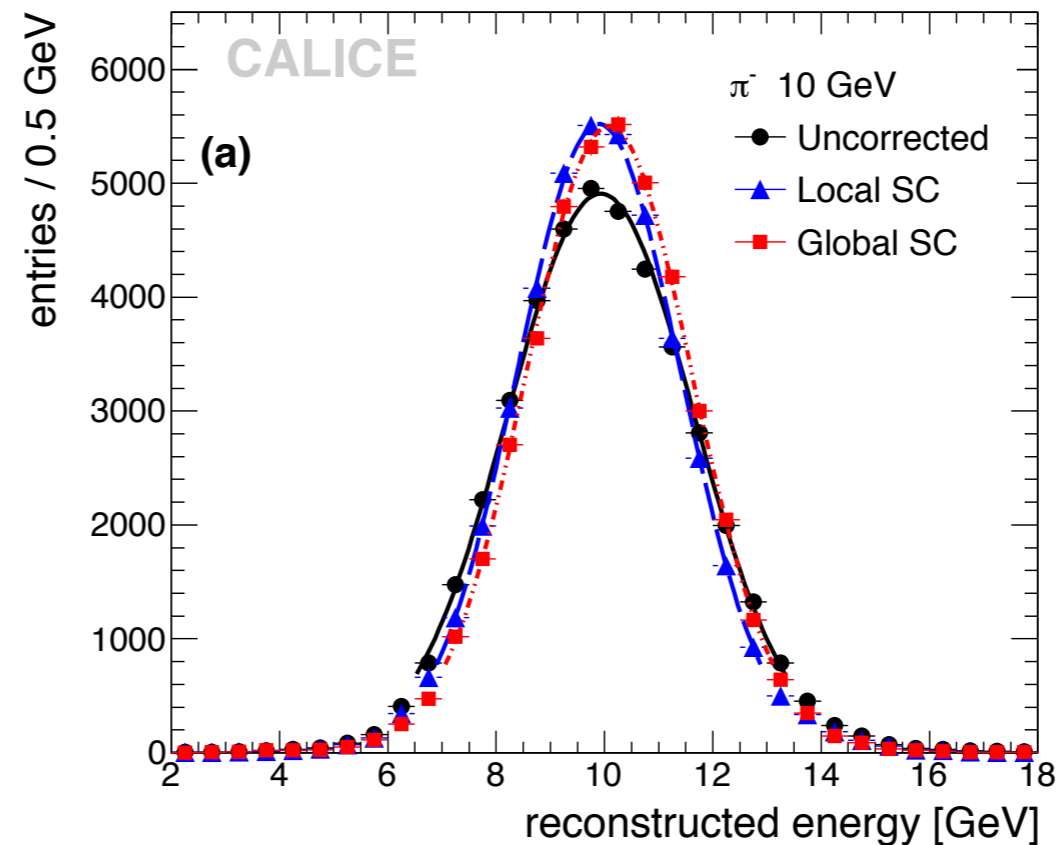

Imaging HCAL with SiPMs - Performance

- Looking deep into showers

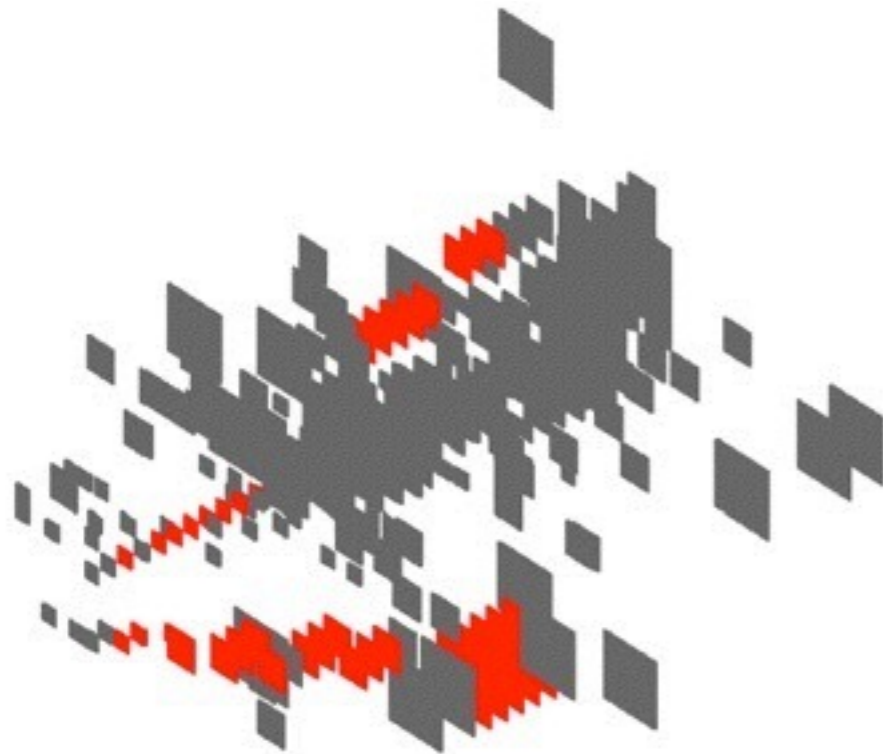

- Reconstructing energy

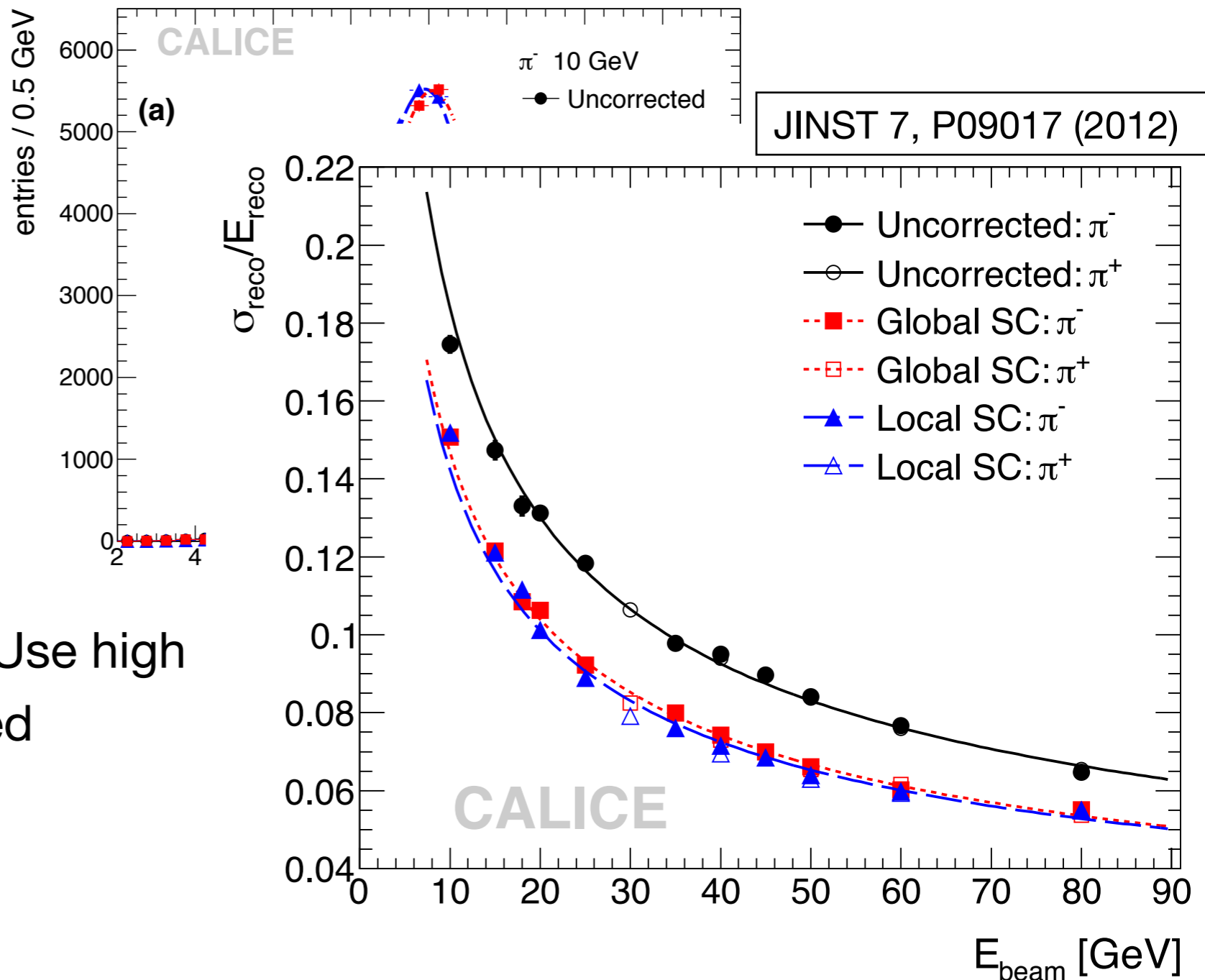

- Excellent energy resolution: Use high granularity for software-based compensation methods:
 $45\%/\sqrt{E} \oplus 1.8\%$

Imaging Calorimeters: Now “Main Stream”

- In spring 2015, CMS has selected the “High Granular Calorimeter” HGCal for the HL-LHC upgrade of its forward calorimeters

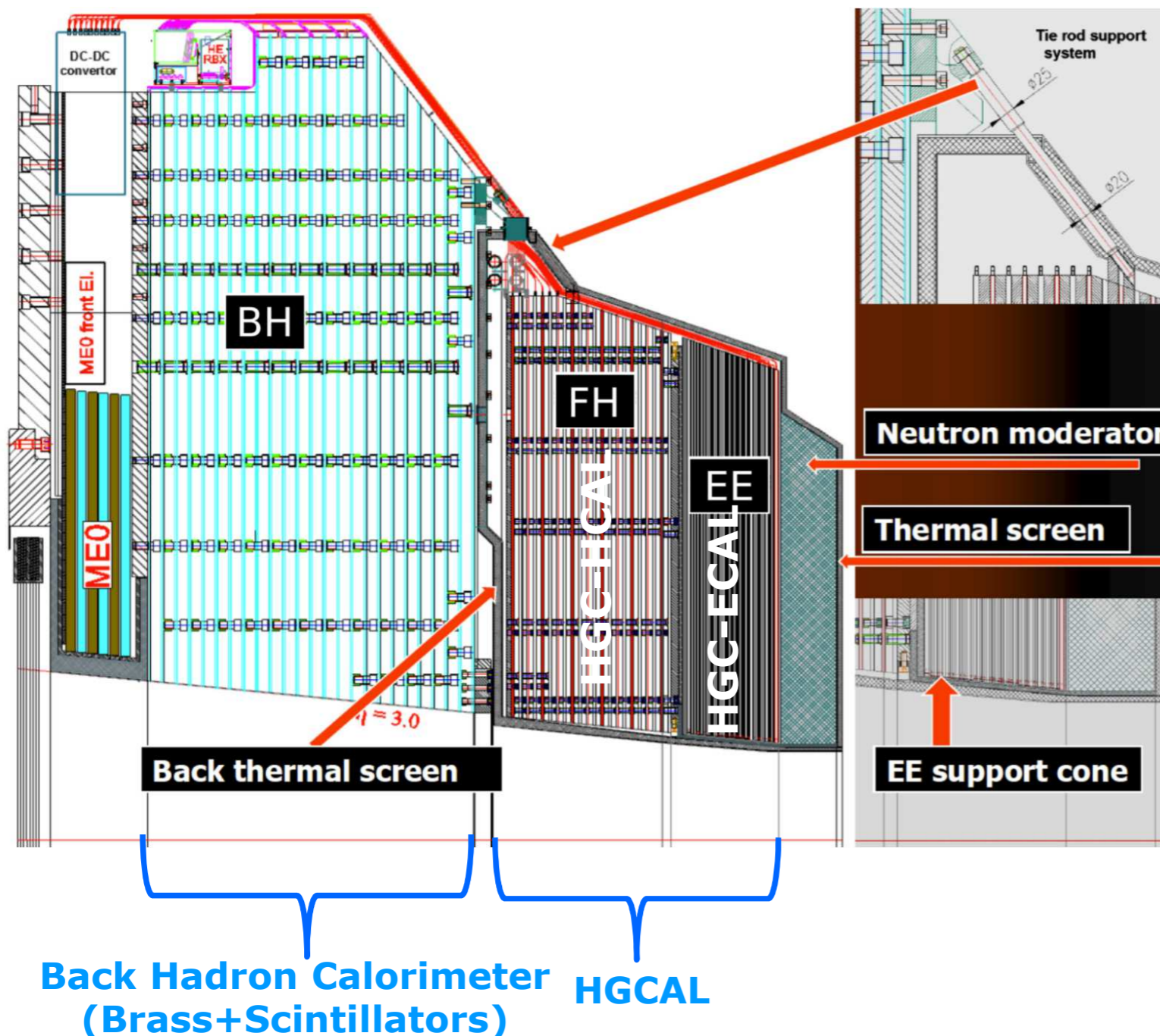

HGC-ECAL:
Silicon sensors
Tungsten / Copper absorber

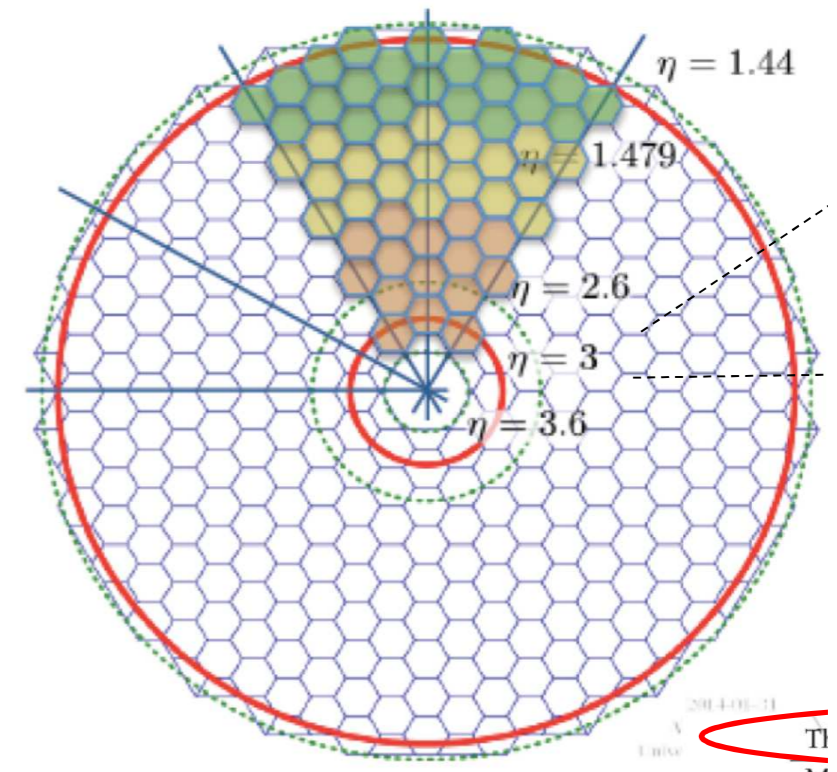

HGC-HCAL:
Silicon sensors
Brass absorbers

Summary

- Event reconstruction with collider detectors:
 - Tracking detectors to measure the momentum of charged particles - Via track curvature in magnetic field
 - Technology: Mostly semi-conductor or gaseous detectors
 - Calorimeters to measure the energy of (almost) all particles
 - Subdivided into
 - Electromagnetic and hadronic calorimeters
 - Homogeneous and sampling calorimeters
 - Reconstruction of invisible particles by the measurement of the total event energy (and of missing energy by applying momentum conservation)

Summary

- Event reconstruction with collider detectors:
 - Tracking detectors to measure the momentum of charged particles - Via track curvature in magnetic field
 - Technology: Mostly semi-conductor or gaseous detectors
 - Calorimeters to measure the energy of (almost) all particles
 - Subdivided into
 - Electromagnetic and hadronic calorimeters
 - Homogeneous and sampling calorimeters
 - Reconstruction of invisible particles by the measurement of the total event energy (and of missing energy by applying momentum conservation)

Next Lecture:

Hadron Colliders (Tevatron & LHC) - S. Bethke, 02.11.2015

Schedule

1.	Introduction	12.10.
2.	Particle Detectors I	19.10.
3.	Particle Detectors II	26.10.
4.	Accelerators	02.11.
5.	Trigger, Data Acquisition, Computing	09.11.
6.	Monte Carlo Generators and Detector Simulation	16.11.
7.	Tests of the Standard Model	23.11.
8.	QCD, Jets, Proton Structure	30.12.
9.	Higgs Physics I	07.12.
10.	Higgs Physics II	14.12.
	----- no lecture -----	21.12.
	----- Christmas -----	
11.	Supersymmetry	11.01.
12.	Top Physics	18.01.
13.	Other models beyond the SM	25.01.
14.	Future Collider Projects	01.02.



Extra Material



Verbesserte Energieauflösung: Kompensation

- Der Detektor-Parameter e/π wird durch die Geometrie und Materialien bestimmt
- Um $e/\pi = 1$ (Kompensation) zu erreichen, muss das Signal des Kalorimeters für Hadronen erhöht werden,
- Aktives Material mit Sensitivität für langsame Neutronen: Plastik-Szintillator mit H
- möglich: Erhöhung der Neutronenaktivität durch bestimmte Absorber, zB Uran

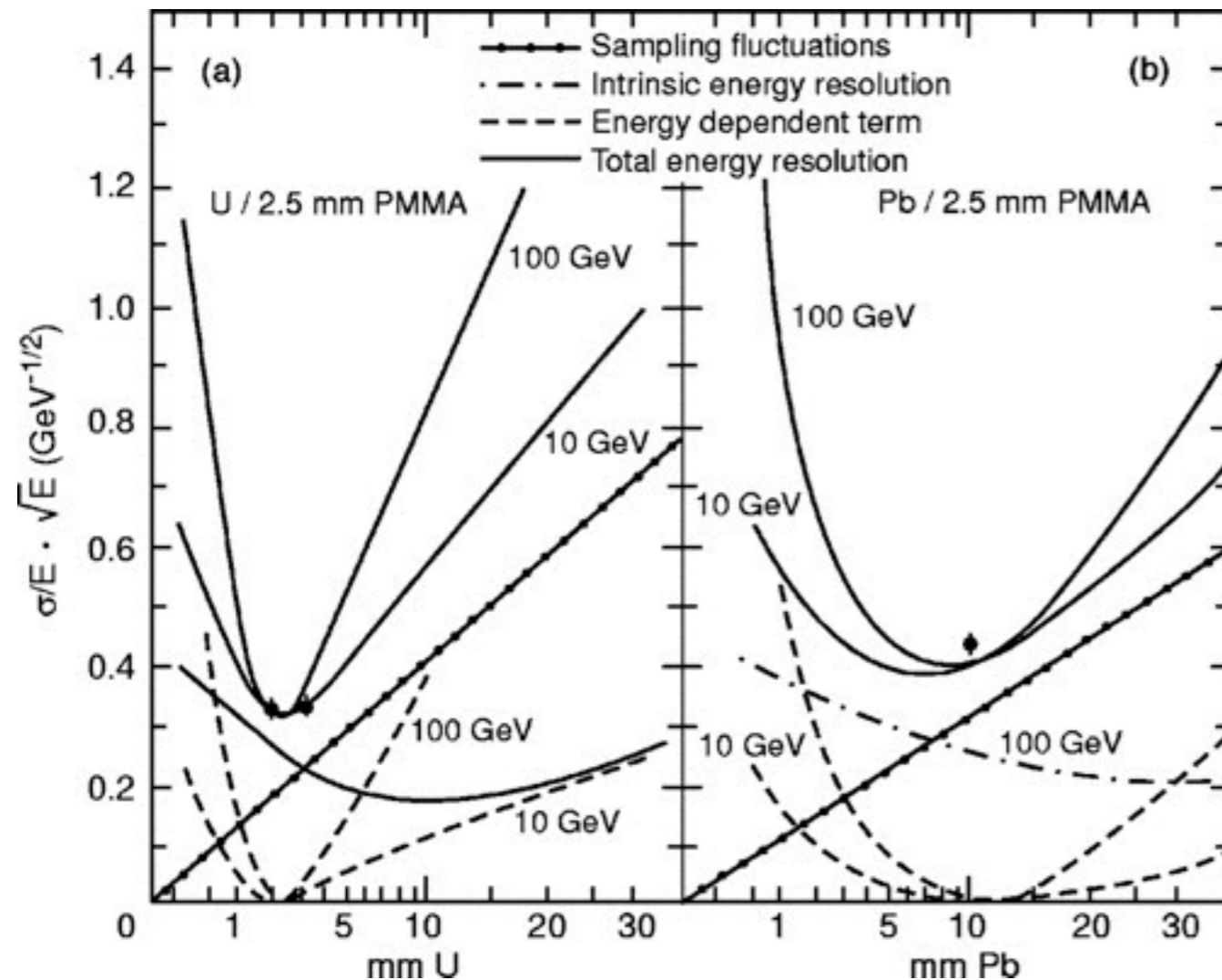

- Kompensation ist bei geeigneter Wahl des Sampling-Verhältnisses möglich

Verbesserte Energieauflösung: Kompensation

- Der Detektor-Parameter e/π wird durch die Geometrie und Materialien bestimmt
- Um $e/\pi = 1$ (Kompensation) zu erreichen, muss das Signal des Kalorimeters für Hadronen erhöht werden,
- Aktives Material mit Sensitivität für langsame Neutronen: Plastik-Szintillator mit H
- möglich: Erhöhung der Neutronenaktivität durch bestimmte Absorber, zB Uran

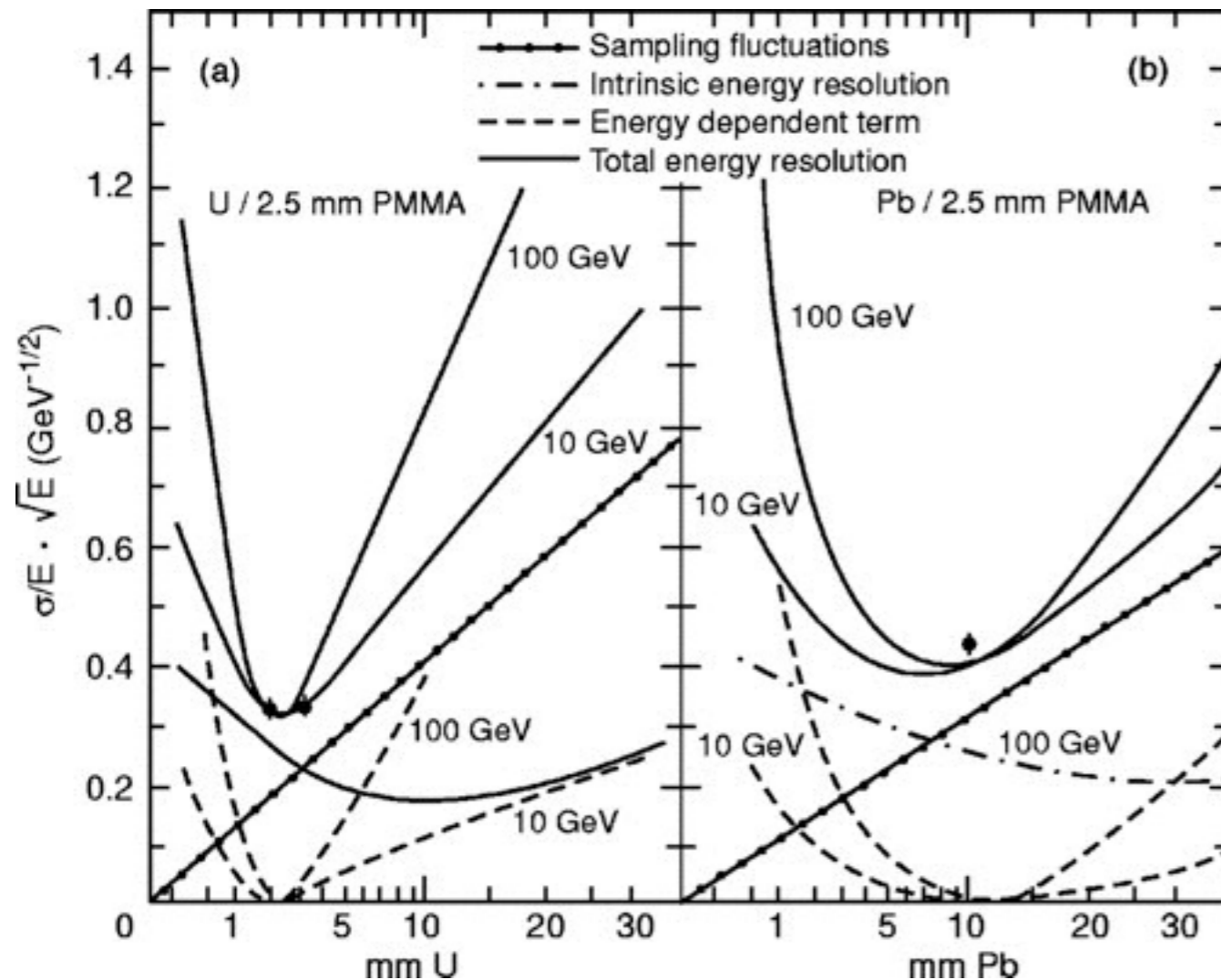

- Kompensation ist bei geeigneter Wahl des Sampling-Verhältnisses möglich

Aber:

- kein (oder fast kein) Material vor dem Kalorimeter!
- Kleine Sampling-Verhältnisse (Absorber mit kleinem X_0):
 ▣ Schlechte EM-Auflösung