

Teilchenphysik mit höchstenergetischen Beschleunigern (Higgs & Co)

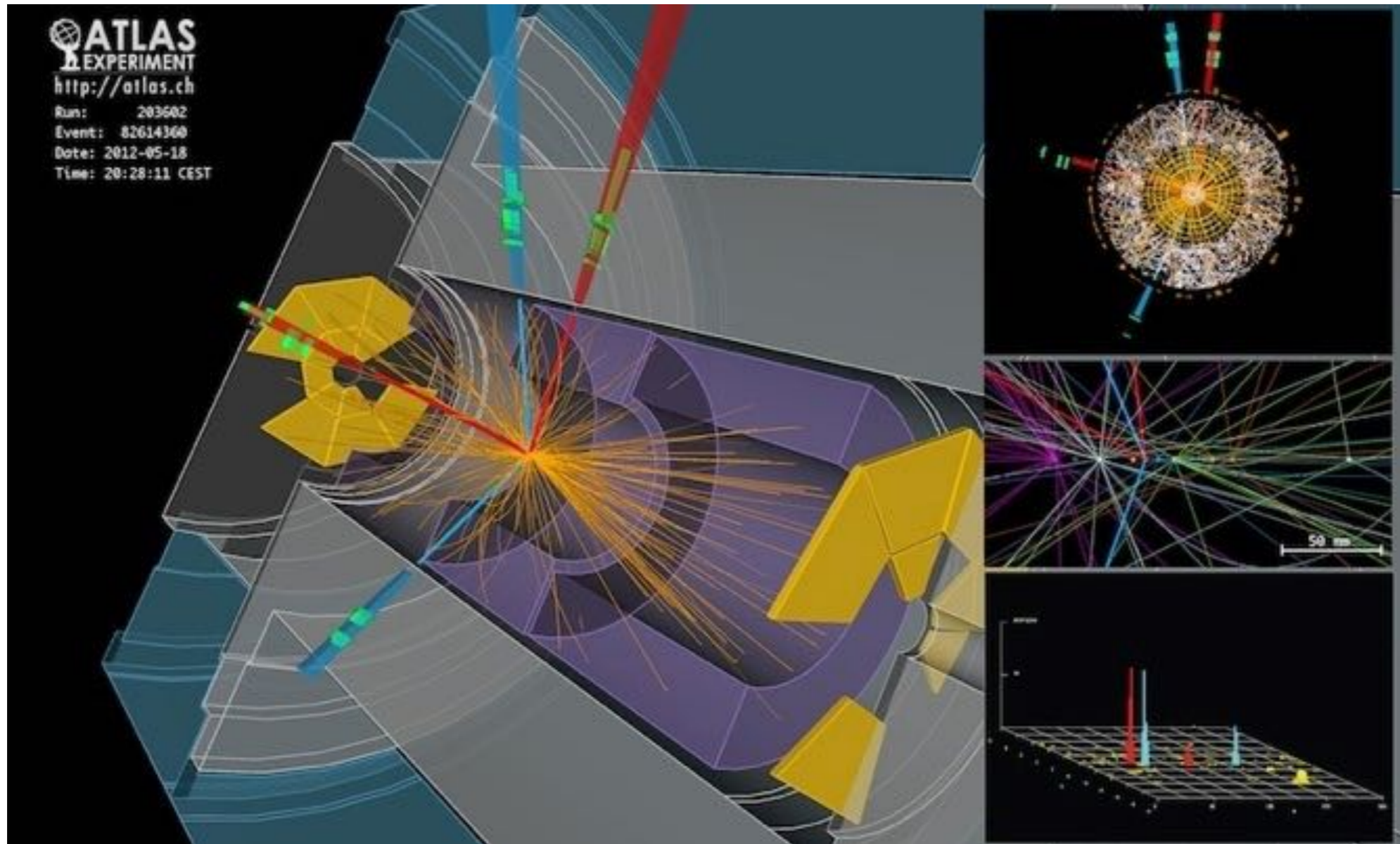

3. Detectors I

07.11.2016



Detectors: Overview

- **Lecture Detectors I**
 - Introduction, overall detector concepts
 - Detector systems at hadron colliders
 - Basics of particle detection: Interaction with matter
 - Methods for particle detection

- **Lecture Detectors II**
 - Tracking detectors: Basics
 - Semiconductor trackers
 - Calorimeters
 - Muon systems

Introduction, Overall Concepts



The Conditions at Hadron Colliders

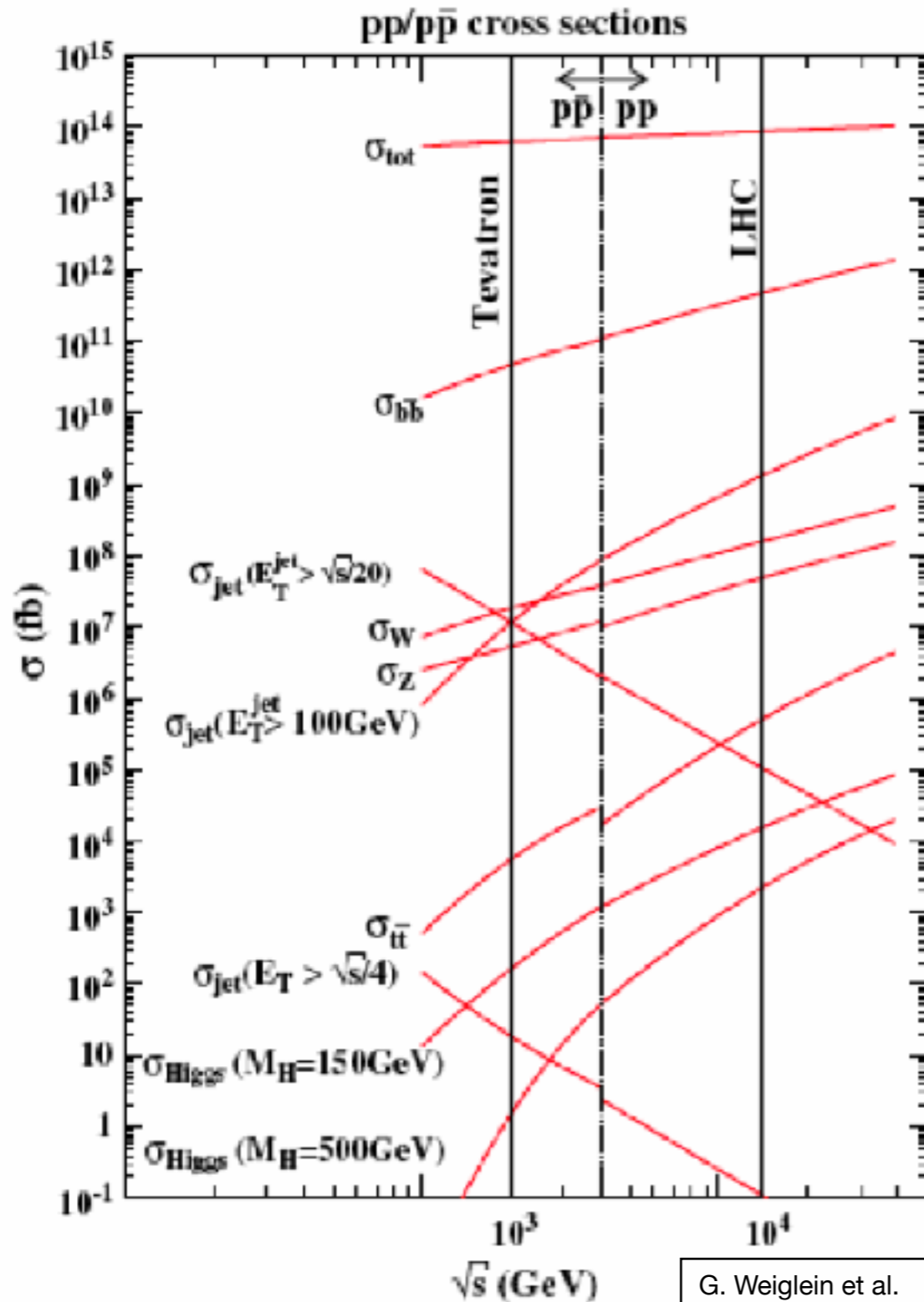

G. Weiglein et al.
Physics Reports 426 (2006) 47–358

- Interesting processes are rare compared to the overall cross section:

$$\sigma(tt)/\sigma_{tot} \sim 10^{-8}$$

$$\sigma(H, M_H = 150 \text{ GeV})/\sigma_{tot} \sim 10^{-10}$$

The Conditions at Hadron Colliders

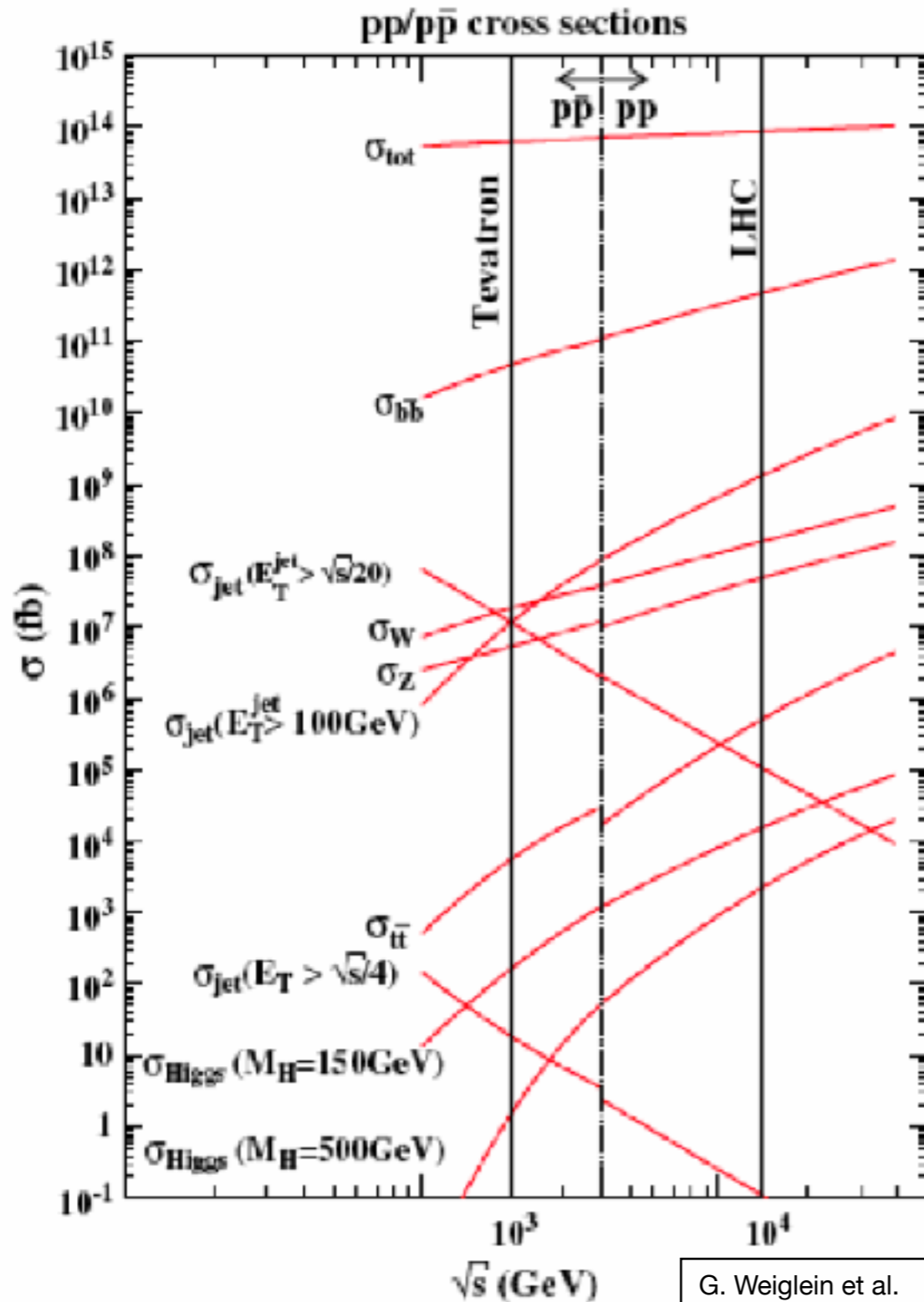

G. Weiglein et al.
Physics Reports 426 (2006) 47–358

- Interesting processes are rare compared to the overall cross section:

$$\sigma(tt̄)/\sigma_{tot} \sim 10^{-8}$$

$$\sigma(H, M_H = 150 \text{ GeV})/\sigma_{tot} \sim 10^{-10}$$

- ▶ Very high event rates required!

The Conditions at Hadron Colliders

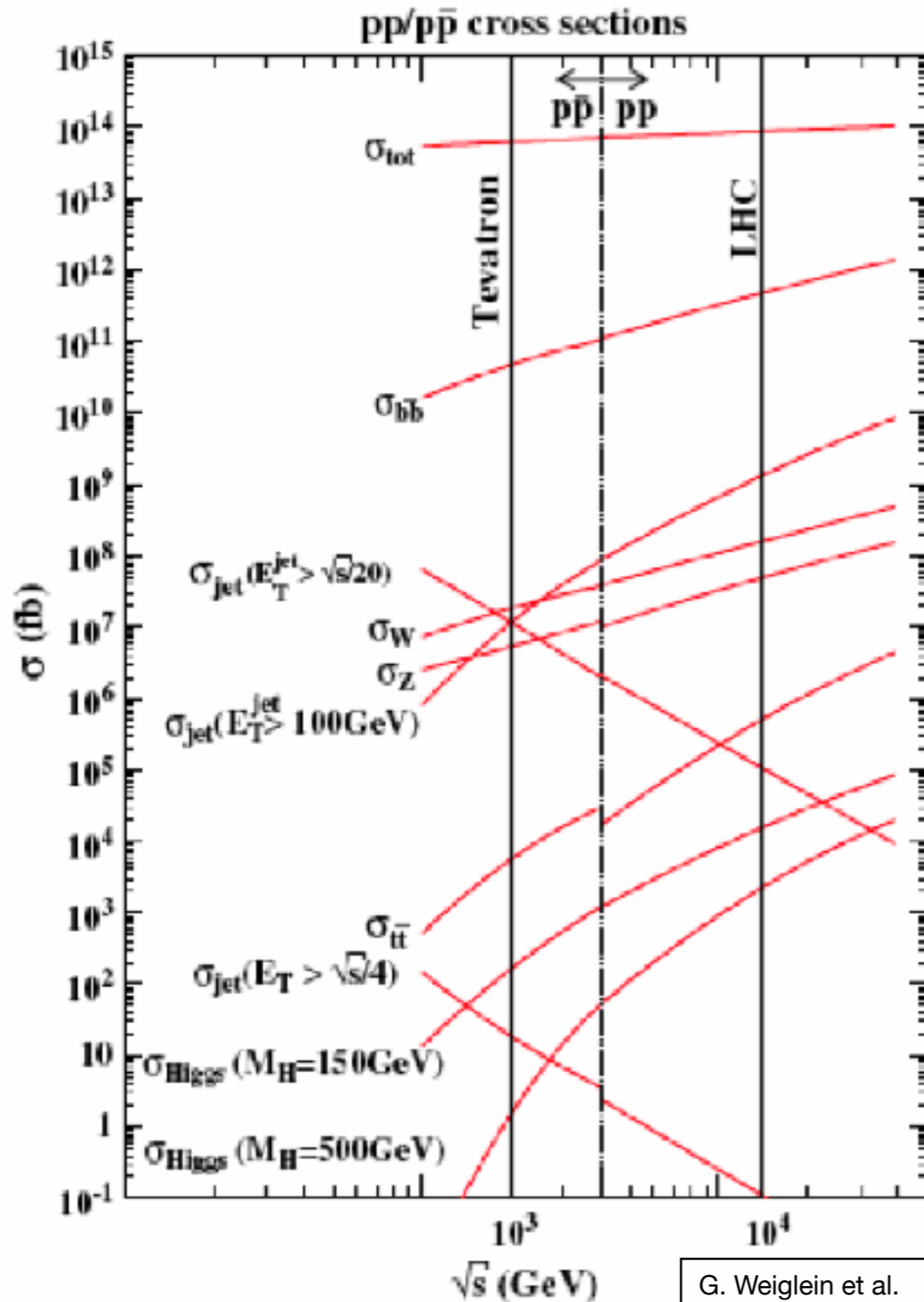

G. Weiglein et al.
Physics Reports 426 (2006) 47–358

- Interesting processes are rare compared to the overall cross section:

$$\sigma(t\bar{t})/\sigma_{tot} \sim 10^{-8}$$

$$\sigma(H, M_H = 150 \text{ GeV})/\sigma_{tot} \sim 10^{-10}$$

- ▶ Very high event rates required!
- ▶ Detectors have to be able to cope with high particle rates and corresponding large amounts of data
- ▶ They have to be able to select (“trigger on”) interesting events

Detector Requirements

- Conditions at LHC:

- Bunch crossing rate: 40 MHz (each 25 ns)

- Design Luminosity:

$$L = 10^{34} \text{ cm}^{-2} \text{ s}^{-1}$$

- pp - cross section:

$$\sigma_{pp} \approx 100 \text{ mb} = 10^{-25} \text{ cm}^2$$

Detector Requirements

- Conditions at LHC:

- Bunch crossing rate: 40 MHz (each 25 ns)

- Design Luminosity:

$$L = 10^{34} \text{ cm}^{-2} \text{ s}^{-1}$$

- pp - cross section:

$$\sigma_{pp} \approx 100 \text{ mb} = 10^{-25} \text{ cm}^2$$

⇒ Interaction rate ~ 1 GHz, approx. 25 p+p - reactions per bunch-crossing

Detector Requirements

- Conditions at LHC:

- Bunch crossing rate: 40 MHz (each 25 ns)

- Design Luminosity:

$$L = 10^{34} \text{ cm}^{-2} \text{ s}^{-1}$$

- pp - cross section:

$$\sigma_{pp} \approx 100 \text{ mb} = 10^{-25} \text{ cm}^2$$

▣ Interaction rate ~ 1 GHz, approx. 25 p+p - reactions per bunch-crossing

- ▶ Detector requirements:

- high granularity to resolve high particle density

- Fast readout, data buffering directly on detector (“pipelines”), typically 128 BX deep

- ▶ Needs a fast decision, if an event is interesting and should be read out for further processing: a maximum of $3.2 \mu\text{s}$ to decide

- High granularity results in high data volume: Maximum rate that can be stored ~ 100 Hz ▣ Trigger and DAQ later in the series!

LHC: Extreme Conditions

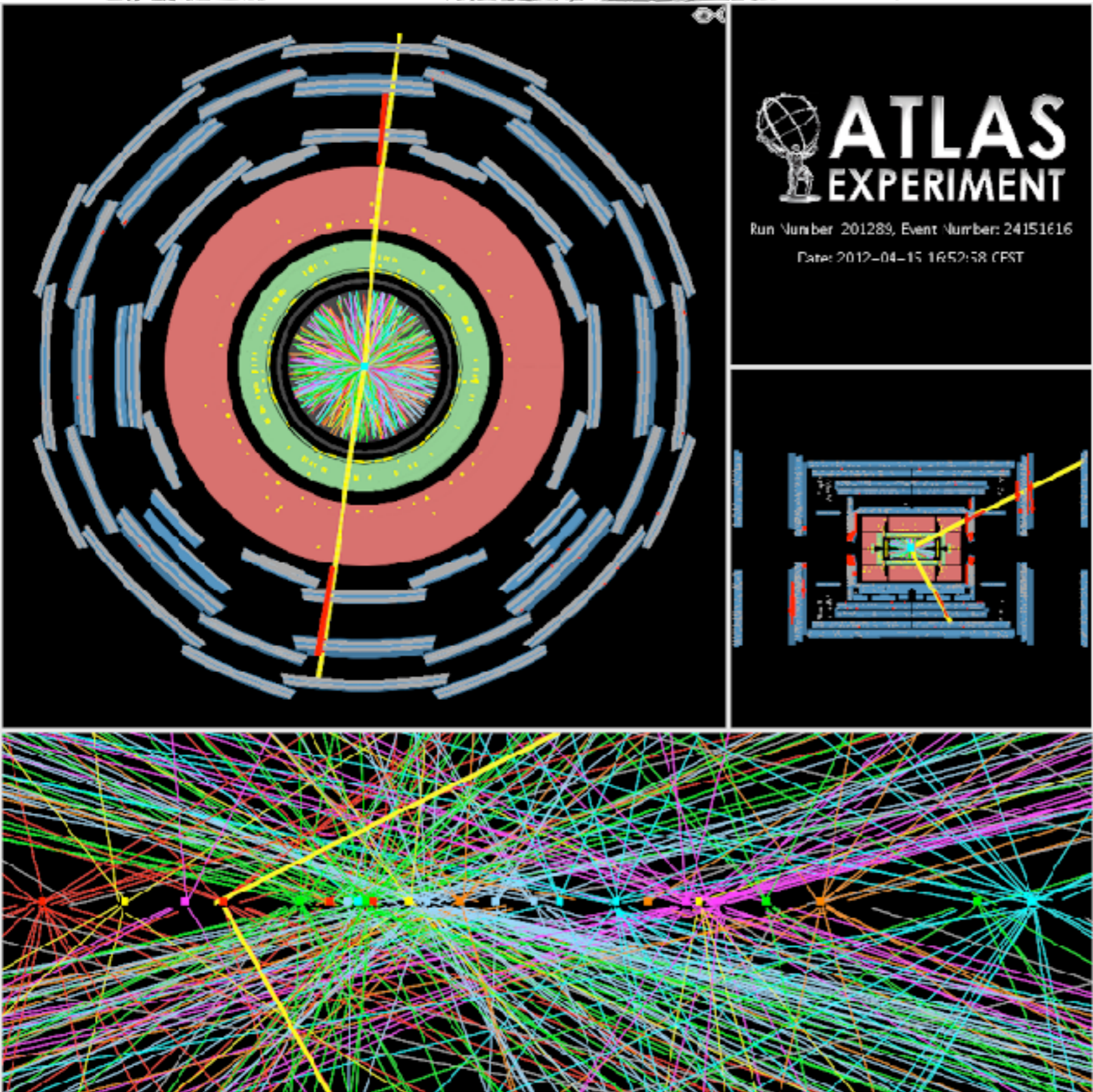

$Z \rightarrow \mu\mu$

... and 25 other collisions

LHC: Extreme Conditions

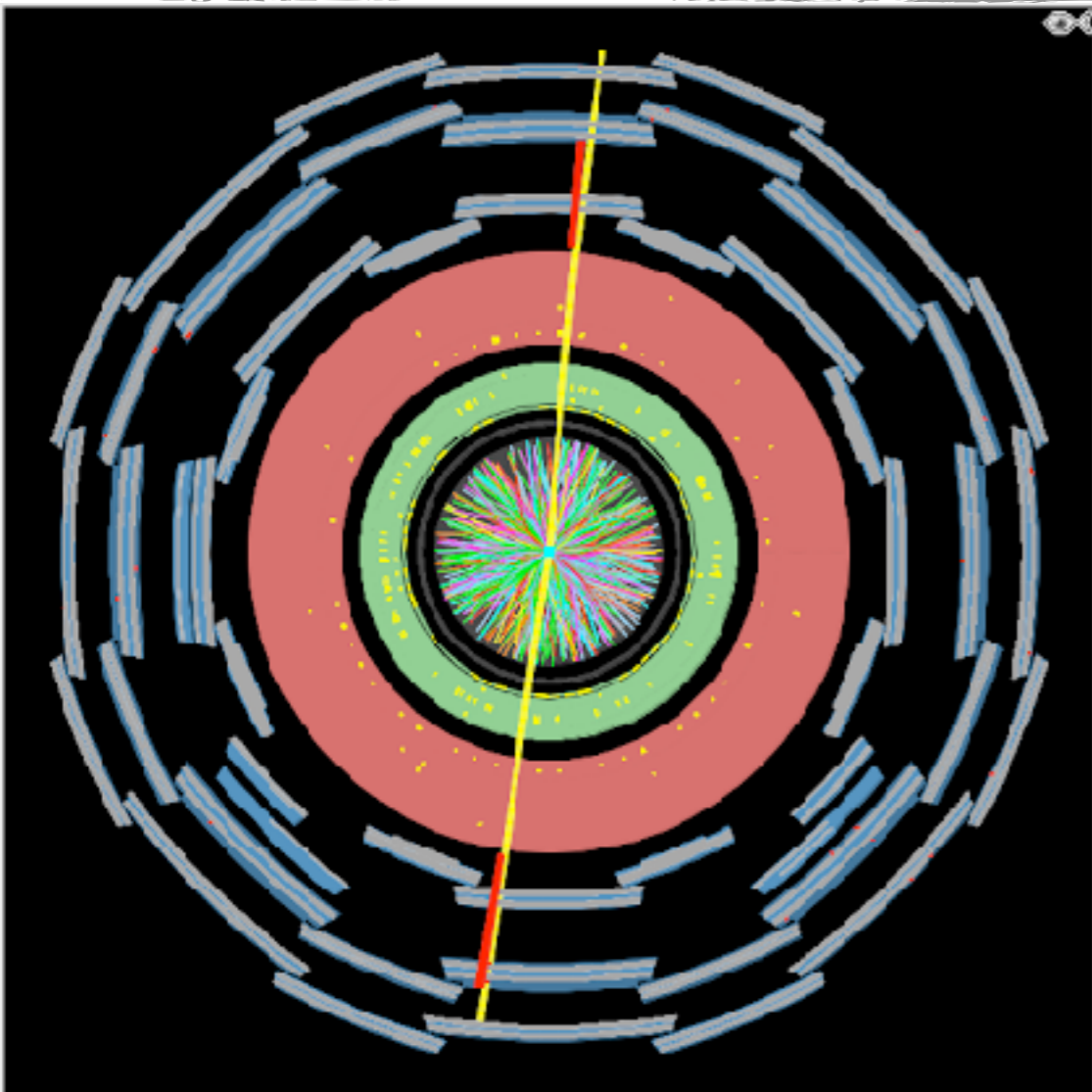

$Z \rightarrow \mu\mu$

... and 25 other collisions

Normal LHC conditions in 2012 data taking - will get more in the future!

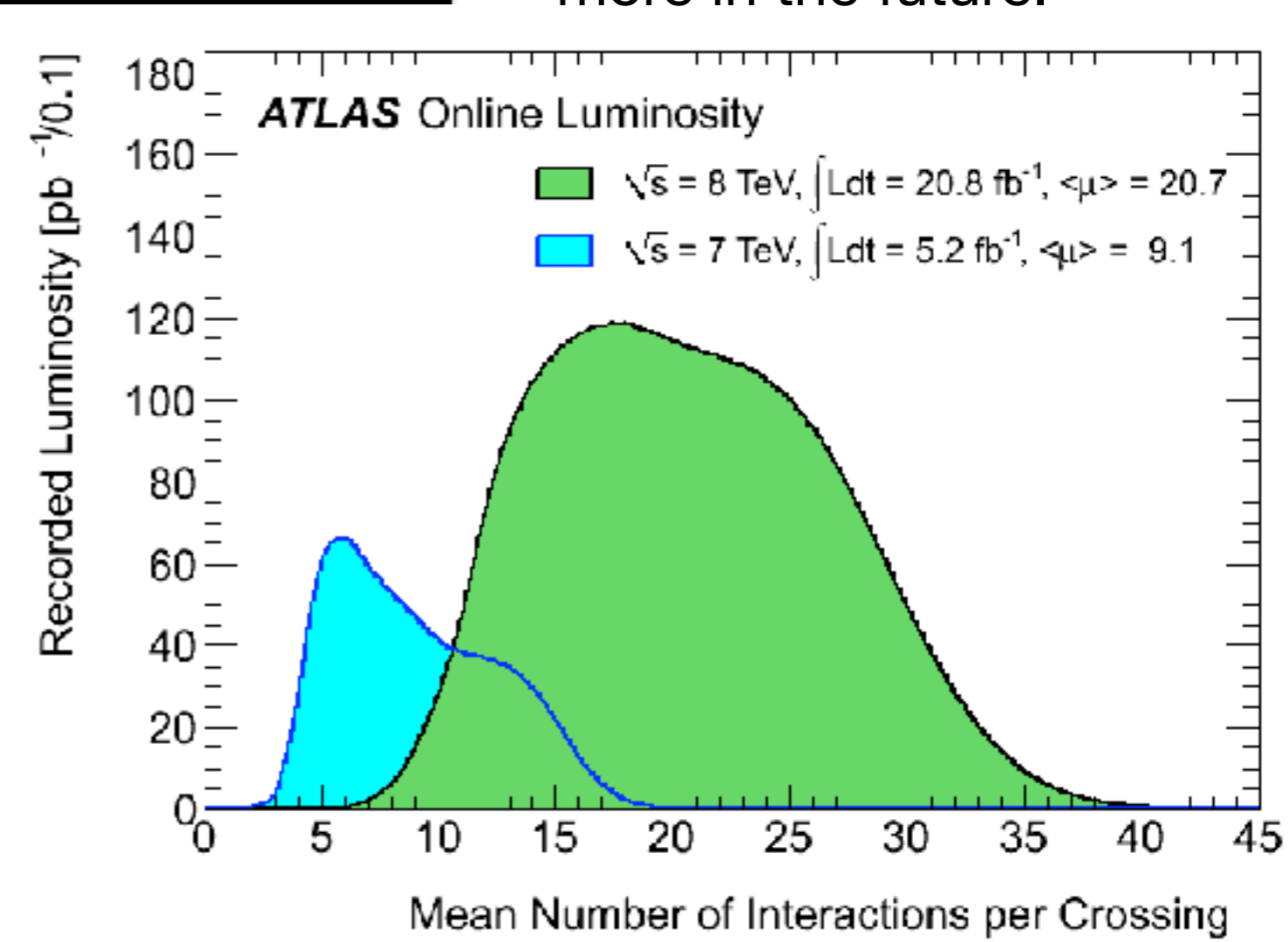
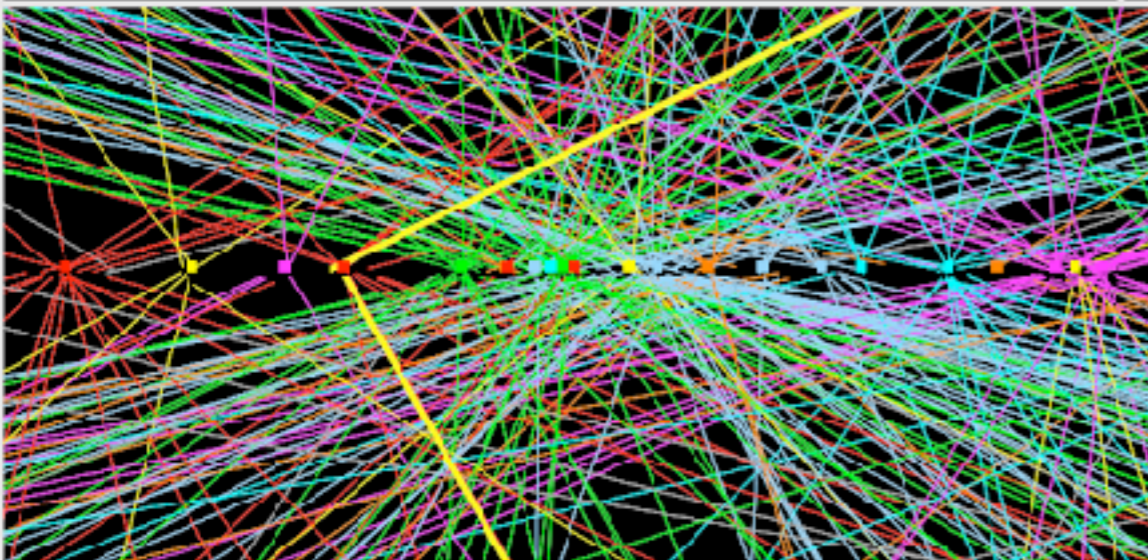

Collider Detectors

- Detection of the final-state particles of the interaction
 - Signals generated via electromagnetic interaction with the detector material

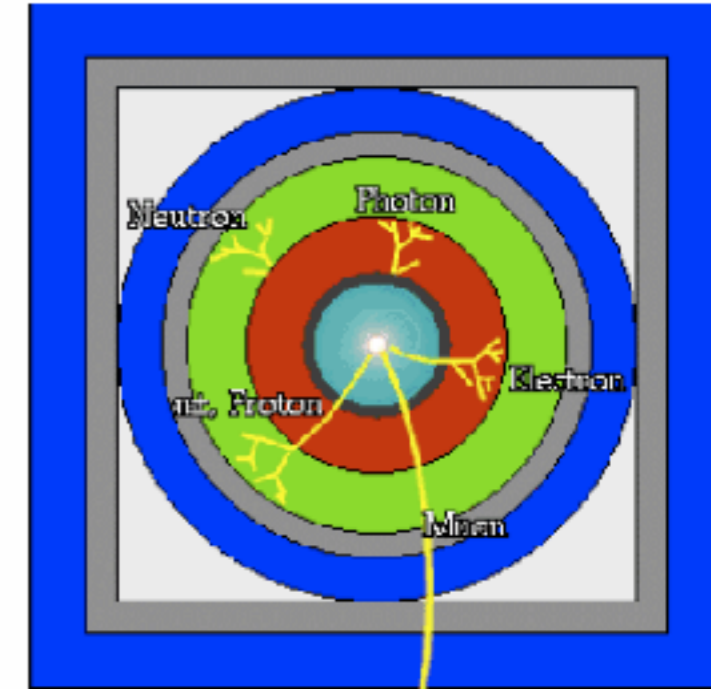
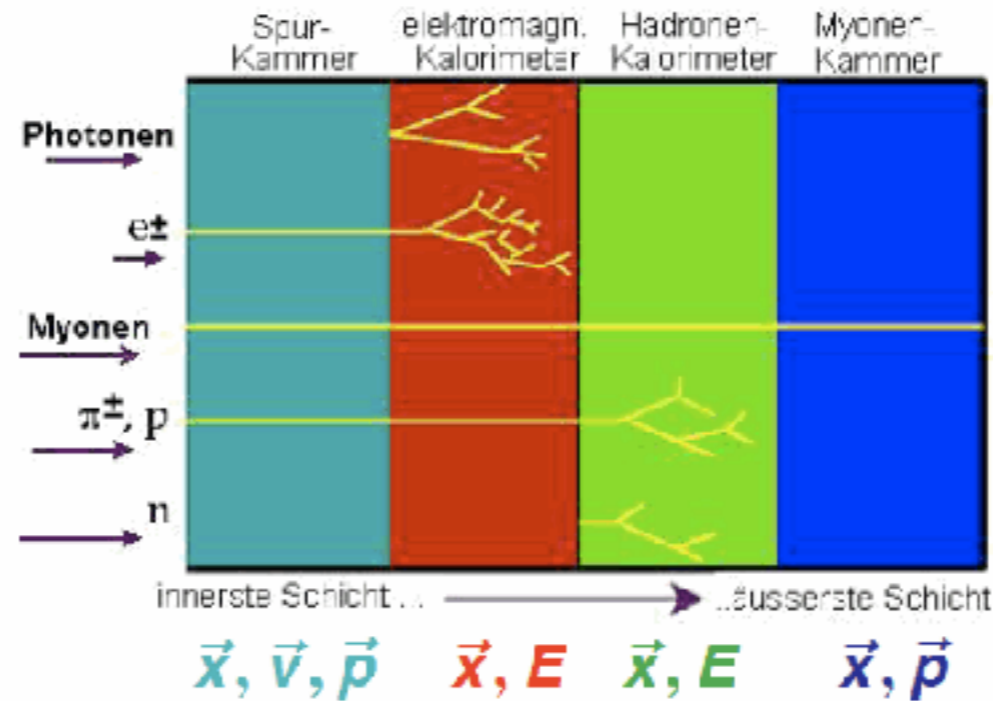
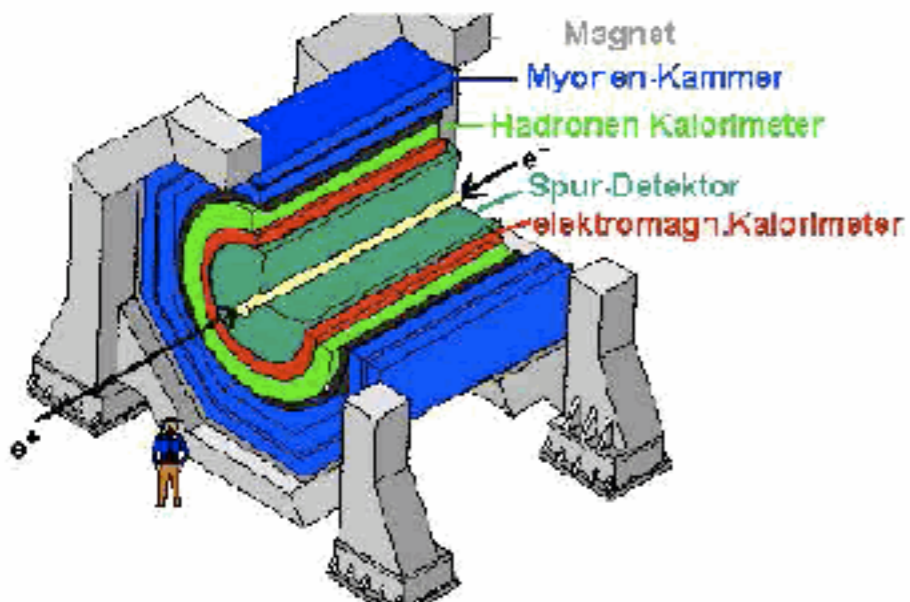

Collider Detectors

- Detection of the final-state particles of the interaction
 - Signals generated via electromagnetic interaction with the detector material

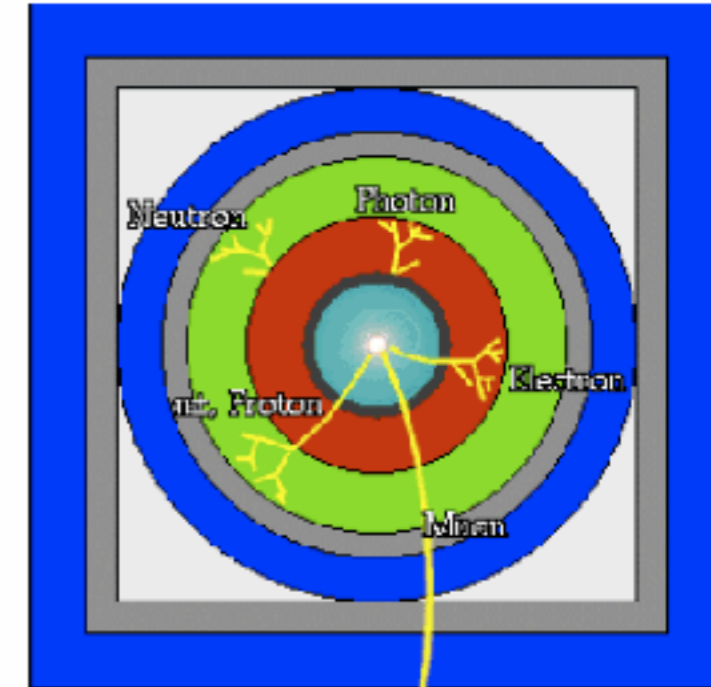
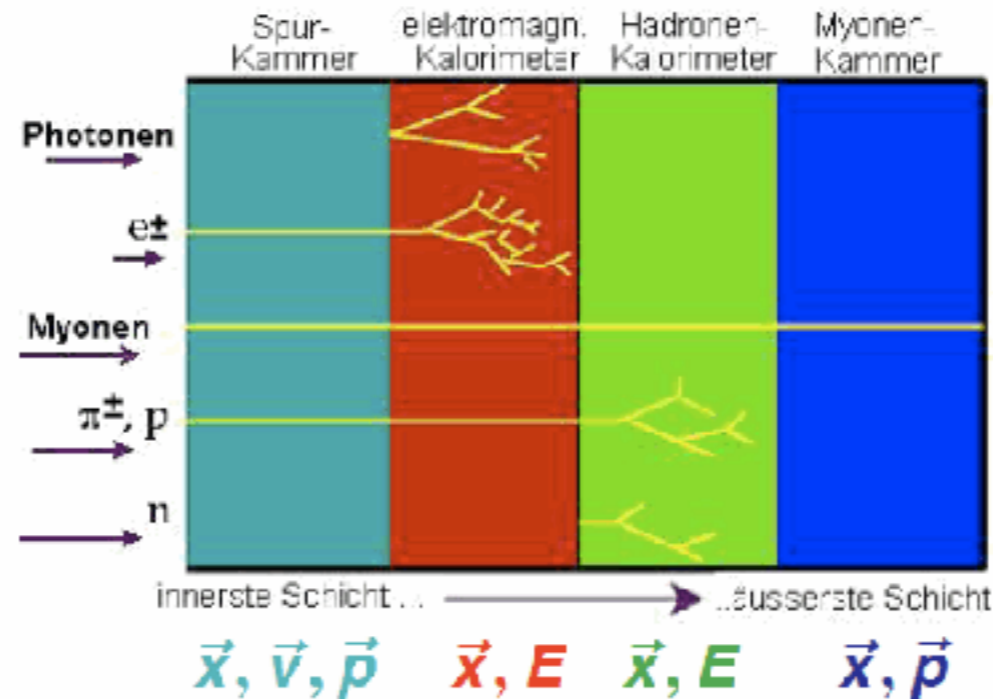
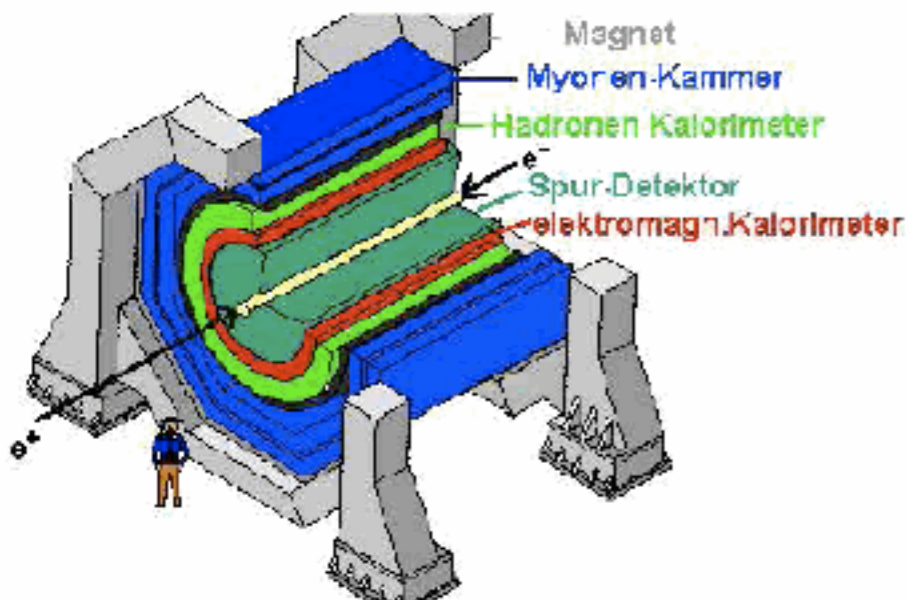

Tracker: Momentum of charged particles via precise measurement of deflection in magnetic field

Collider Detectors

- Detection of the final-state particles of the interaction
 - Signals generated via electromagnetic interaction with the detector material

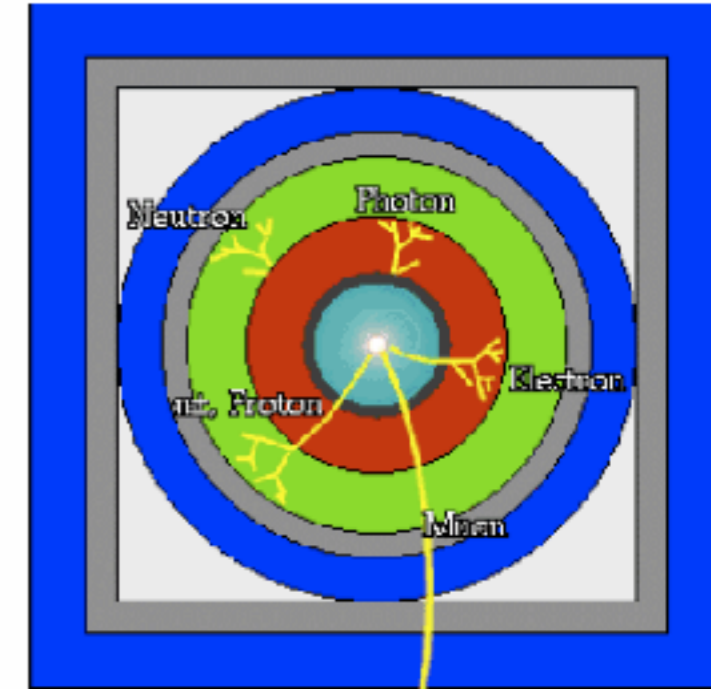
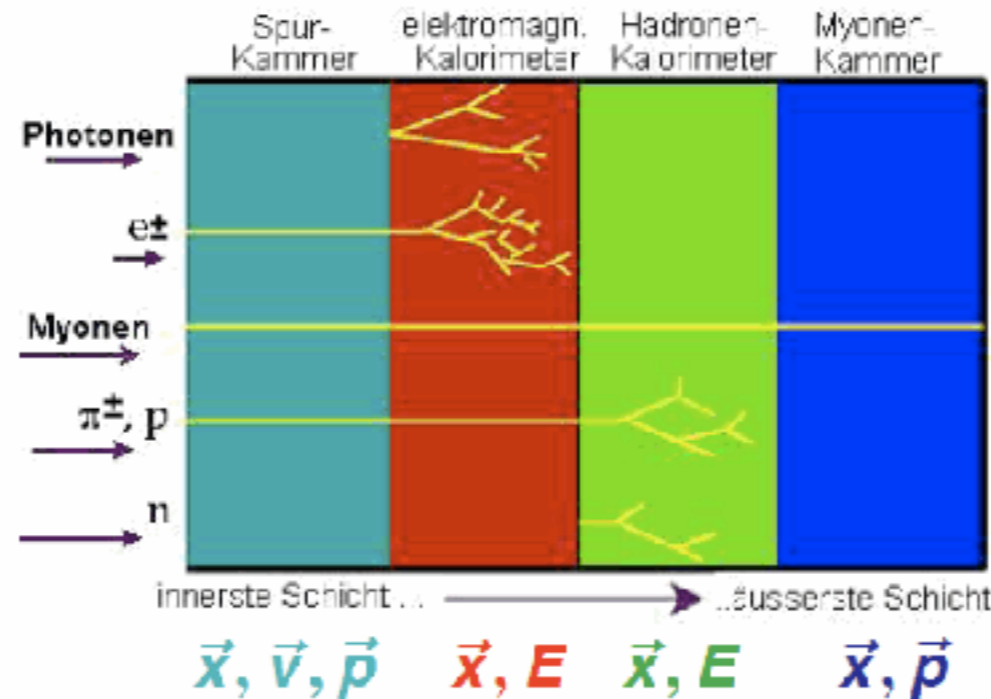
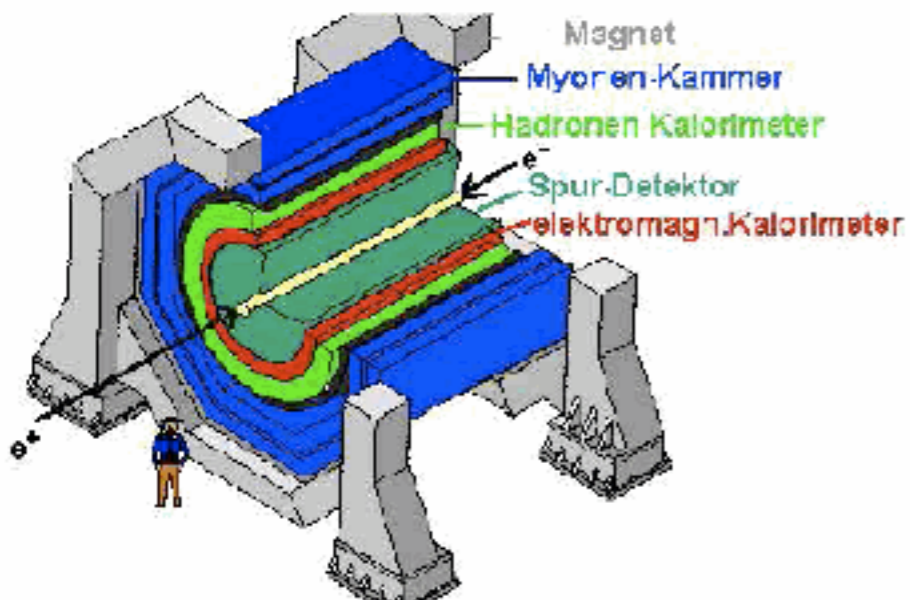

Tracker: Momentum of charged particles via precise measurement of deflection in magnetic field

Calorimeters: Energy measurement for photons, electrons and hadrons by total absorption

Collider Detectors

- Detection of the final-state particles of the interaction
 - Signals generated via electromagnetic interaction with the detector material

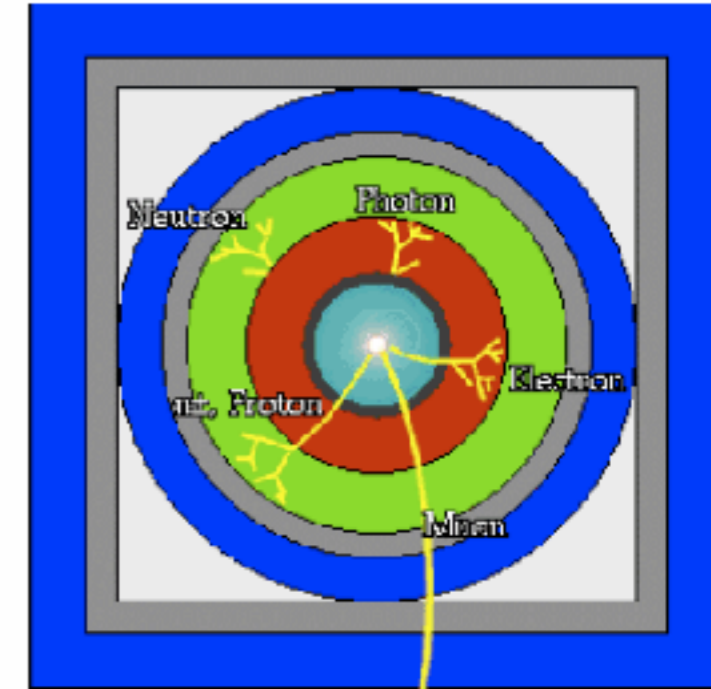
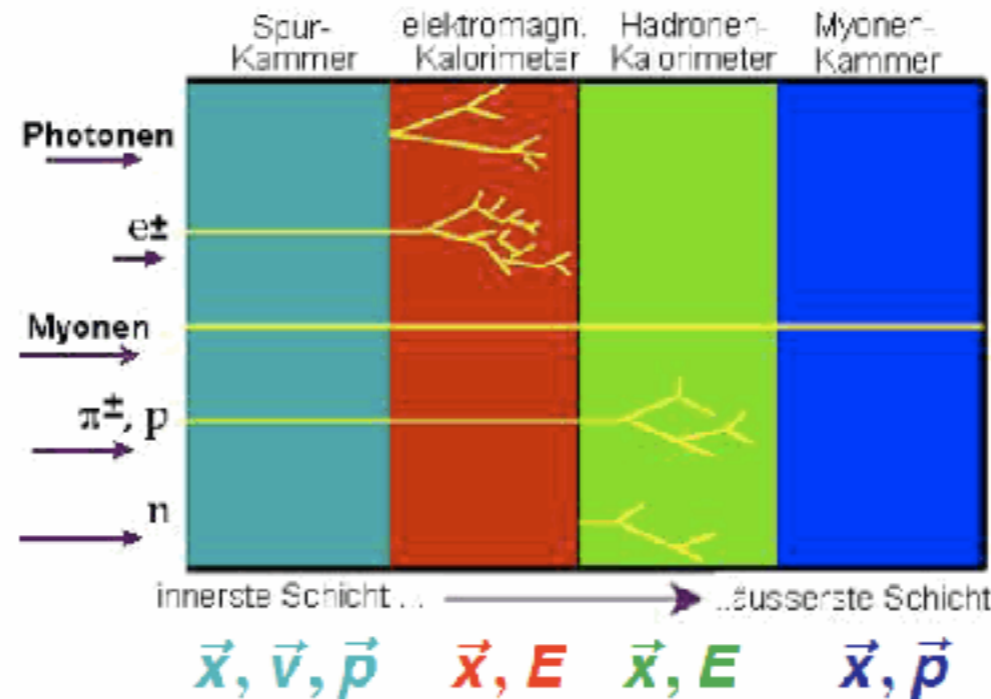
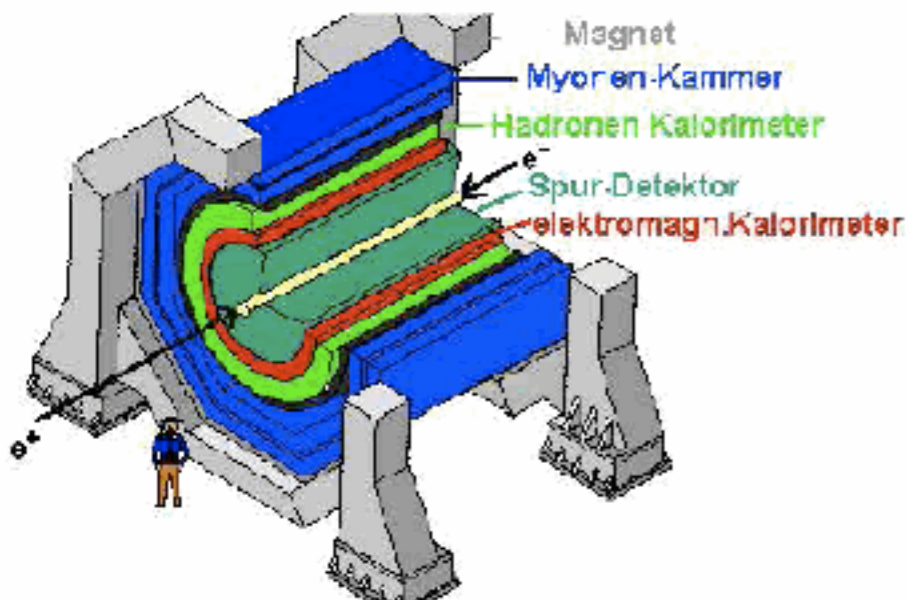

Tracker: Momentum of charged particles via precise measurement of deflection in magnetic field

Calorimeters: Energy measurement for photons, electrons and hadrons by total absorption

Muon detectors: Identification and precise momentum measurement outside of the main magnet

Generic Detector Construction Guide



Generic Detector Construction Guide

1. Vertex Tracker as close as possible to interaction point: Identification of secondary decays, for example from b-Quarks

Generic Detector Construction Guide

1. Vertex Tracker as close as possible to interaction point: Identification of secondary decays, for example from b-Quarks
2. Main Tracker: Measurement of location and momentum of all charged particles, some times also with particle ID

Generic Detector Construction Guide

1. Vertex Tracker as close as possible to interaction point: Identification of secondary decays, for example from b-Quarks
2. Main Tracker: Measurement of location and momentum of all charged particles, some times also with particle ID
3. Particle ID: Time-of-flight measurement, Cherenkov detectors,... (optional)

Generic Detector Construction Guide

1. Vertex Tracker as close as possible to interaction point: Identification of secondary decays, for example from b-Quarks
2. Main Tracker: Measurement of location and momentum of all charged particles, some times also with particle ID
3. Particle ID: Time-of-flight measurement, Cherenkov detectors,... (optional)
4. Calorimeter (electromagnetic, hadronic): Energy measurement of charged and neutral particles

Generic Detector Construction Guide

1. Vertex Tracker as close as possible to interaction point: Identification of secondary decays, for example from b-Quarks
2. Main Tracker: Measurement of location and momentum of all charged particles, some times also with particle ID
3. Particle ID: Time-of-flight measurement, Cherenkov detectors,... (optional)
4. Calorimeter (electromagnetic, hadronic): Energy measurement of charged and neutral particles
5. Muon Detectors: Improved tracking and identification of muons

Generic Detector Construction Guide

1. Vertex Tracker as close as possible to interaction point: Identification of secondary decays, for example from b-Quarks
 2. Main Tracker: Measurement of location and momentum of all charged particles, some times also with particle ID
 3. Particle ID: Time-of-flight measurement, Cherenkov detectors,... (optional)
 4. Calorimeter (electromagnetic, hadronic): Energy measurement of charged and neutral particles
 5. Muon Detectors: Improved tracking and identification of muons
- 1. - 3. have to be inside of a magnet to measure momentum

Generic Detector Construction Guide

1. Vertex Tracker as close as possible to interaction point: Identification of secondary decays, for example from b-Quarks
 2. Main Tracker: Measurement of location and momentum of all charged particles, some times also with particle ID
 3. Particle ID: Time-of-flight measurement, Cherenkov detectors,... (optional)
 4. Calorimeter (electromagnetic, hadronic): Energy measurement of charged and neutral particles
 5. Muon Detectors: Improved tracking and identification of muons
- 1. - 3. have to be inside of a magnet to measure momentum
 - Ideally also include the calorimeters inside of the magnet to limit (dead) material in front of the detectors

Generic Detector Construction Guide

1. Vertex Tracker as close as possible to interaction point: Identification of secondary decays, for example from b-Quarks
 2. Main Tracker: Measurement of location and momentum of all charged particles, some times also with particle ID
 3. Particle ID: Time-of-flight measurement, Cherenkov detectors,... (optional)
 4. Calorimeter (electromagnetic, hadronic): Energy measurement of charged and neutral particles
 5. Muon Detectors: Improved tracking and identification of muons
- 1. - 3. have to be inside of a magnet to measure momentum
 - Ideally also include the calorimeters inside of the magnet to limit (dead) material in front of the detectors
- ▶ 6. A big (and strong) magnet!

Detector Systems at Hadron Colliders



Collider Detectors: Cross Section [CMS]

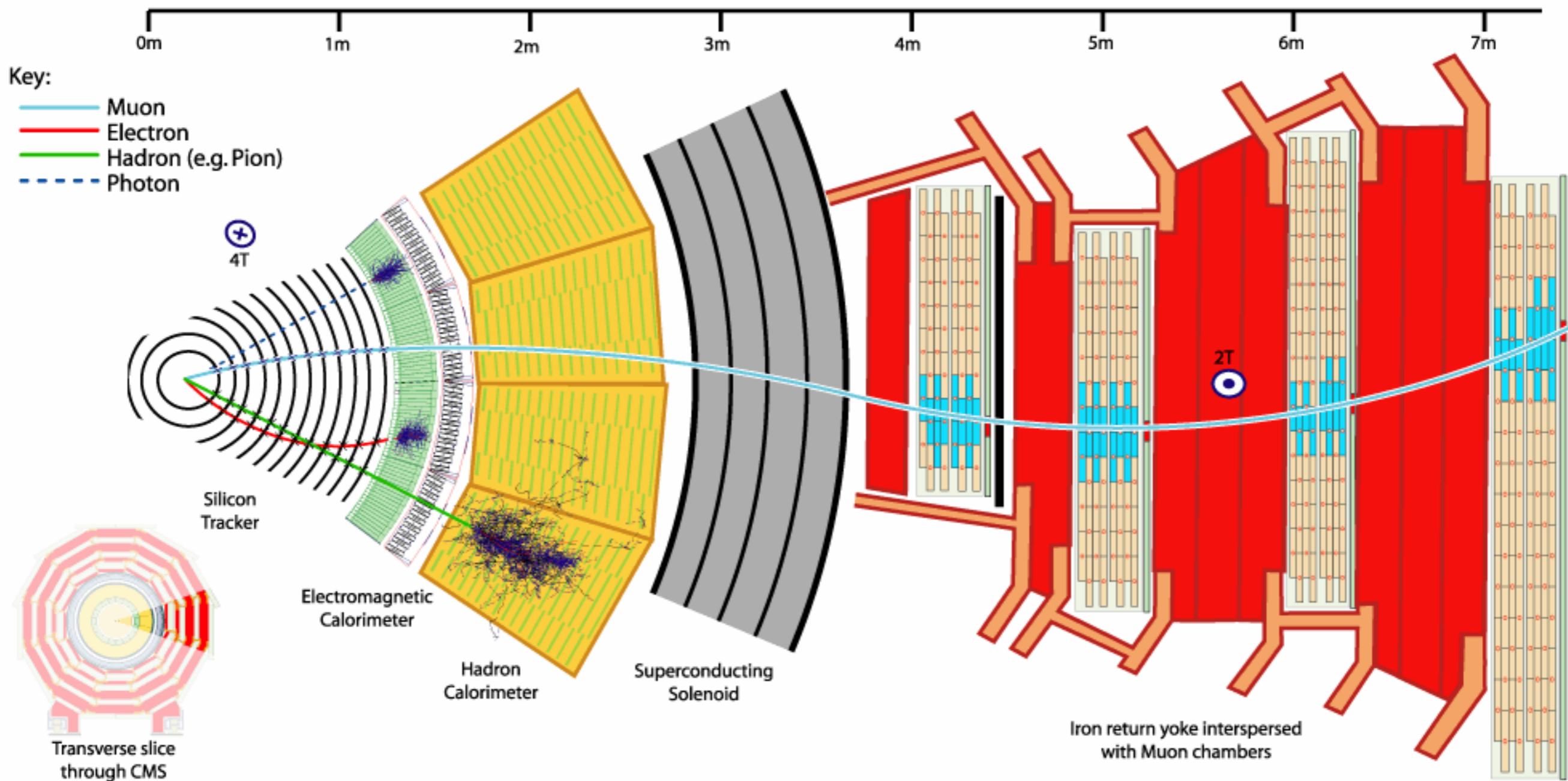

- The high energies require high magnetic fields and large detectors
- Here: CMS, where the “C” is for “compact”

CMS: The Heavy Weight

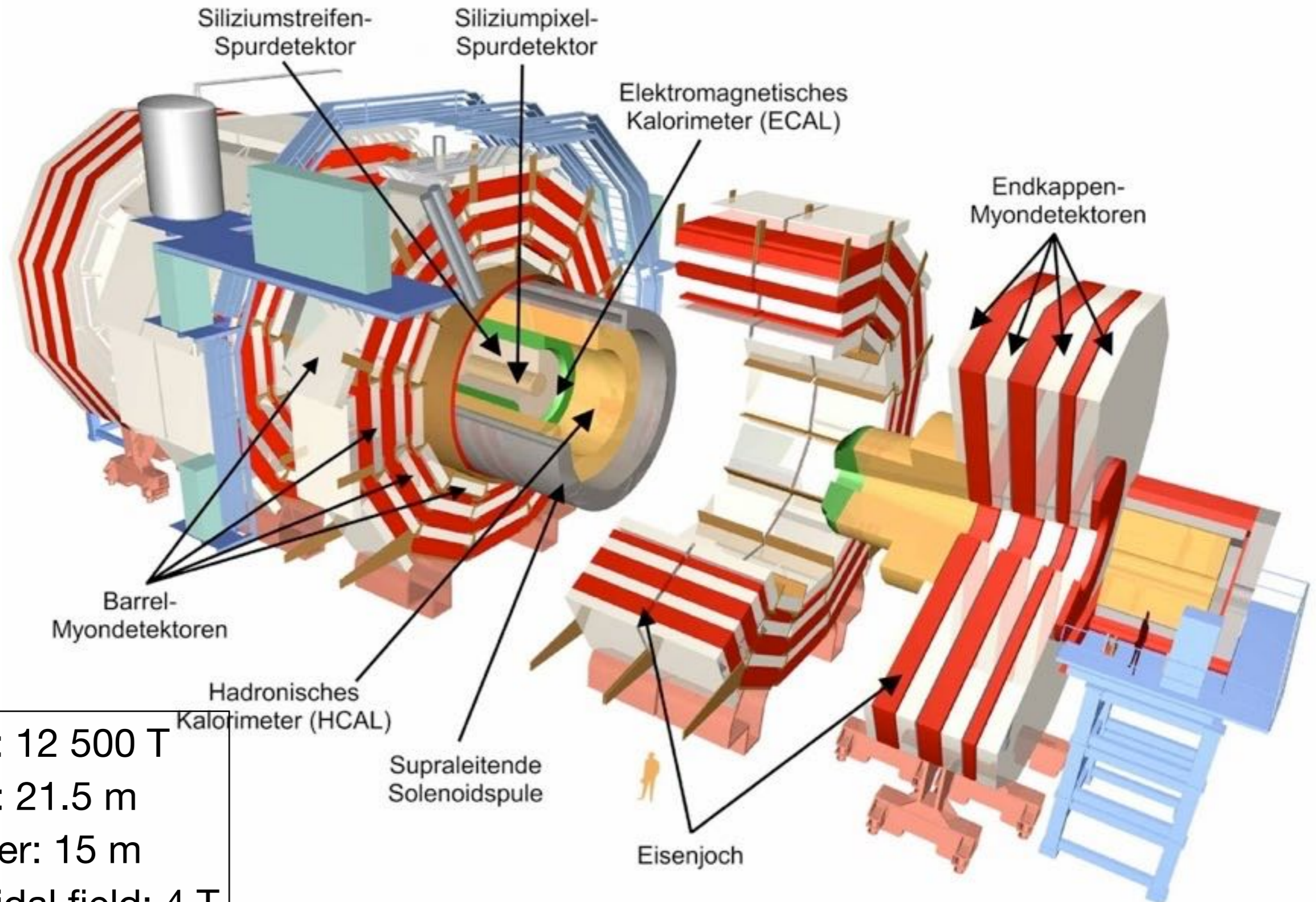

Weight: 12 500 T
Length: 21.5 m
Diameter: 15 m
Solenoidal field: 4 T

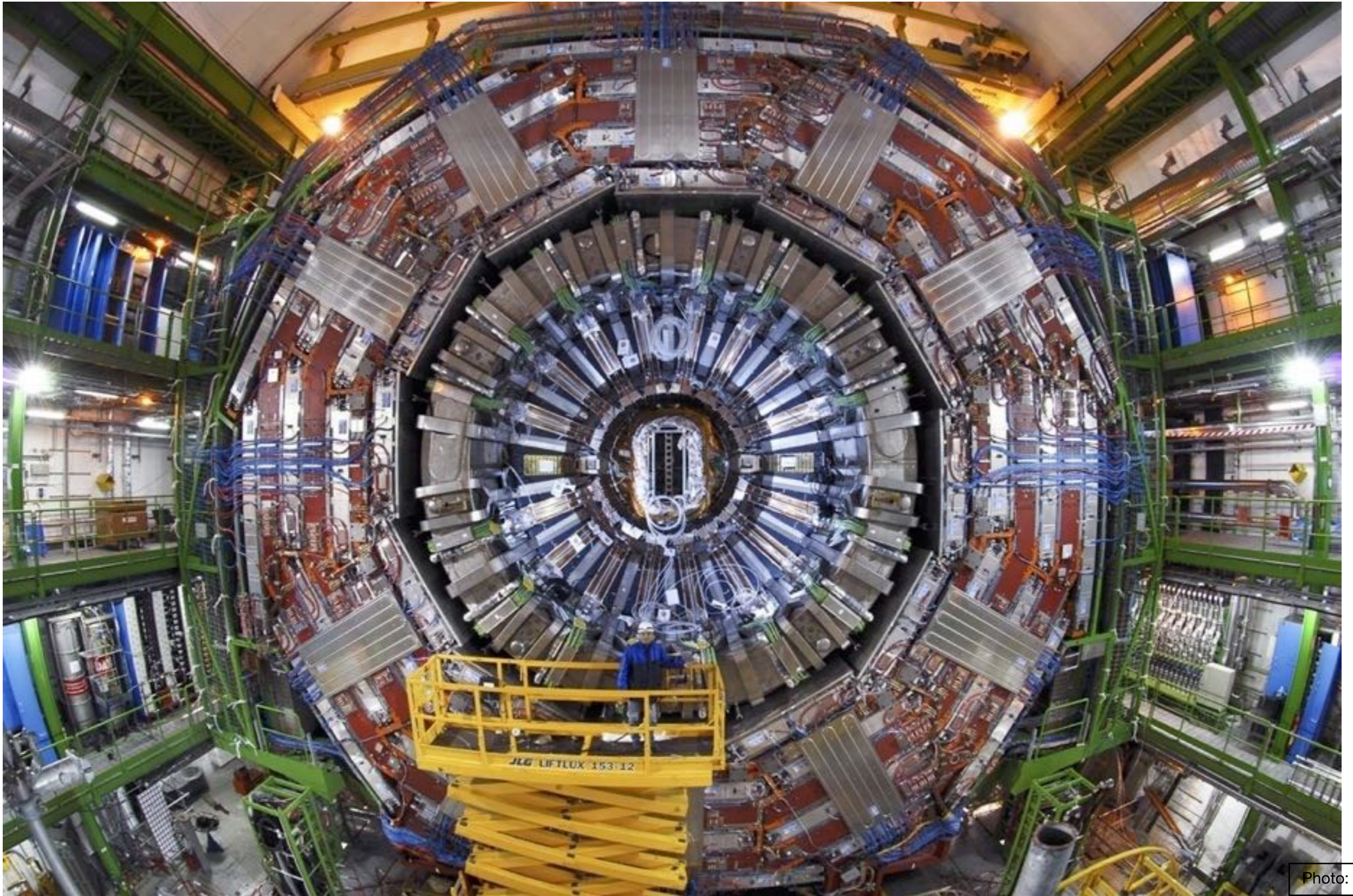
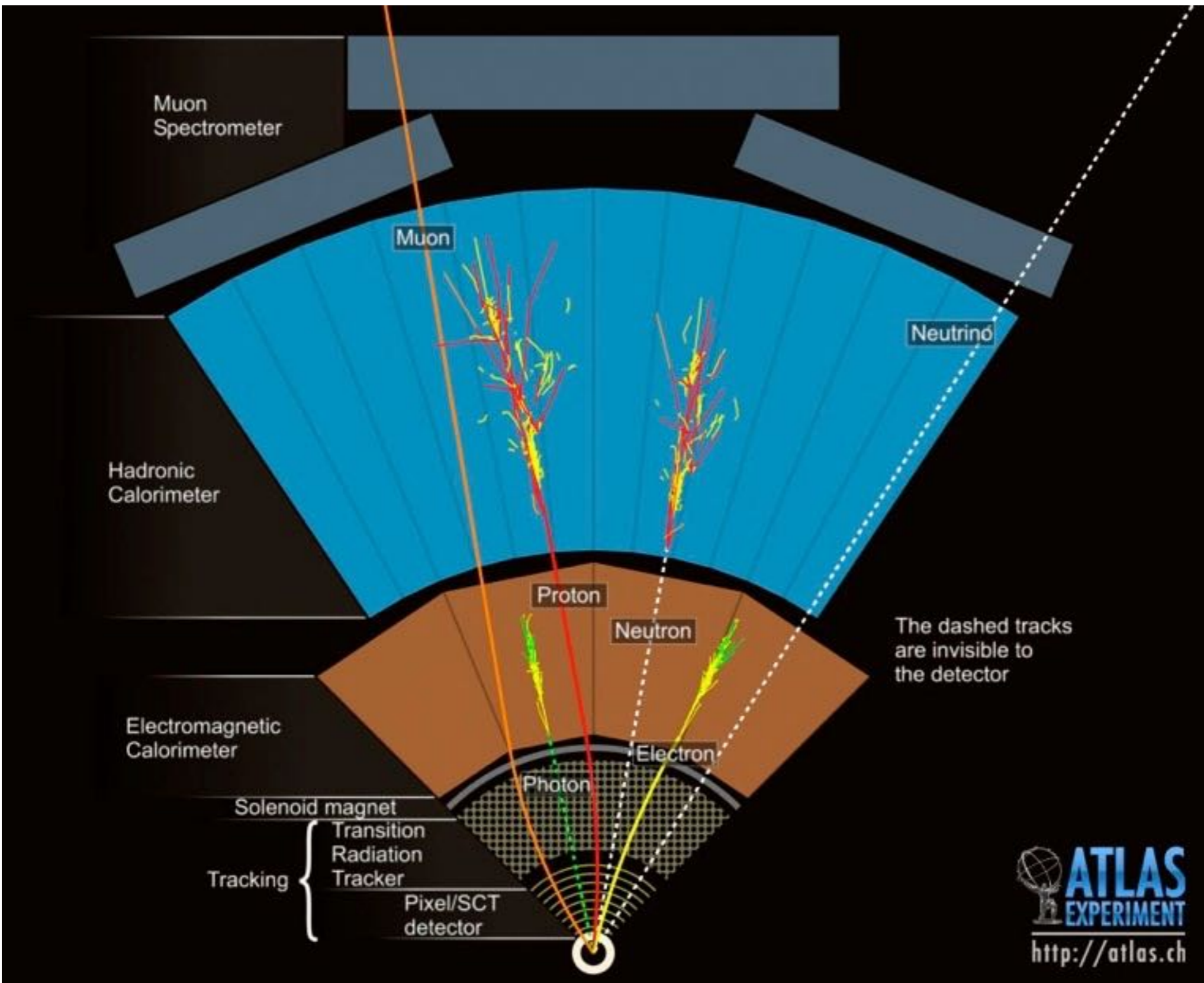

Photo: CERN



Particles in ATLAS



ATLAS: The biggest Detector in Particle Physics

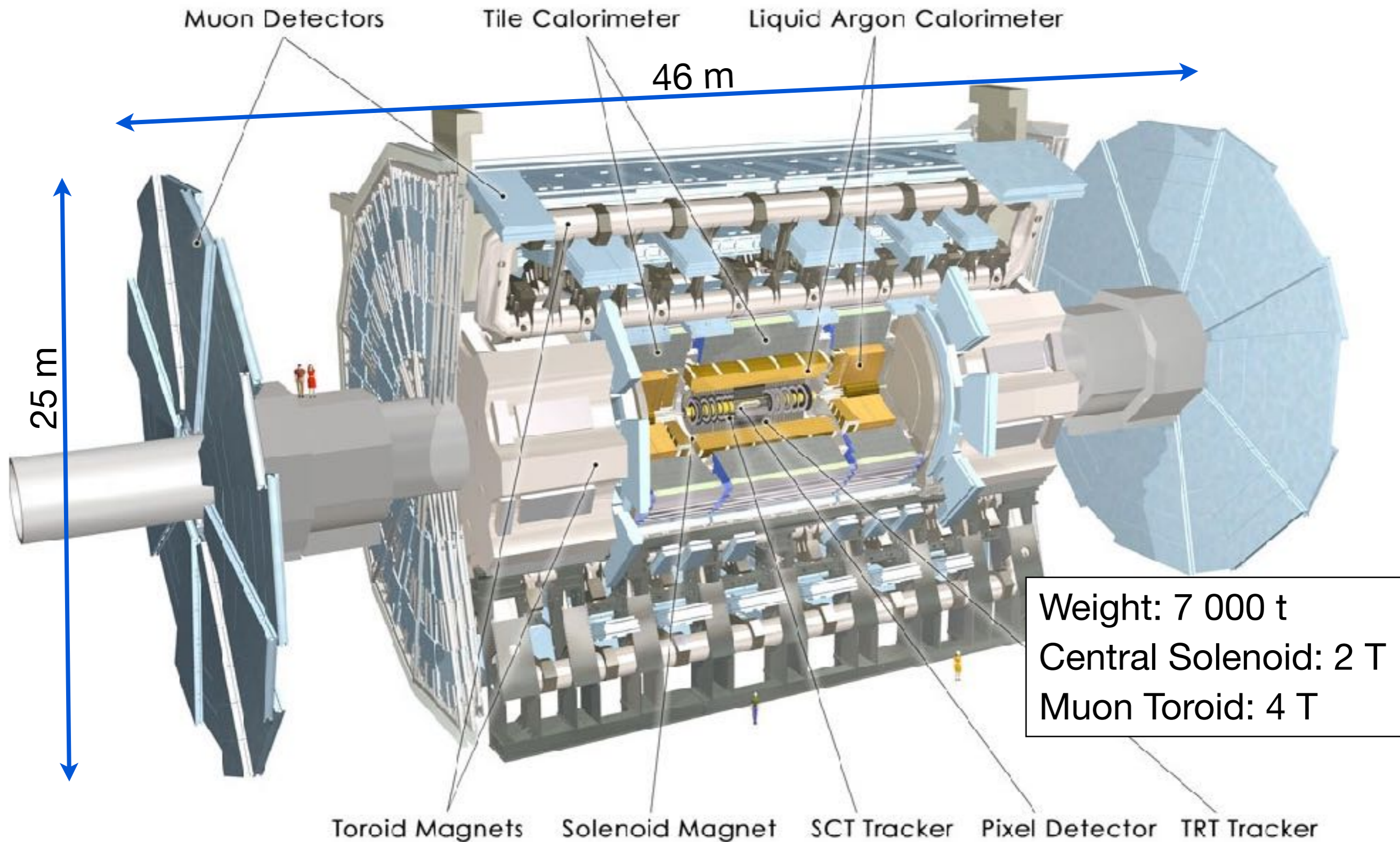

Illustration: CERN

ATLAS

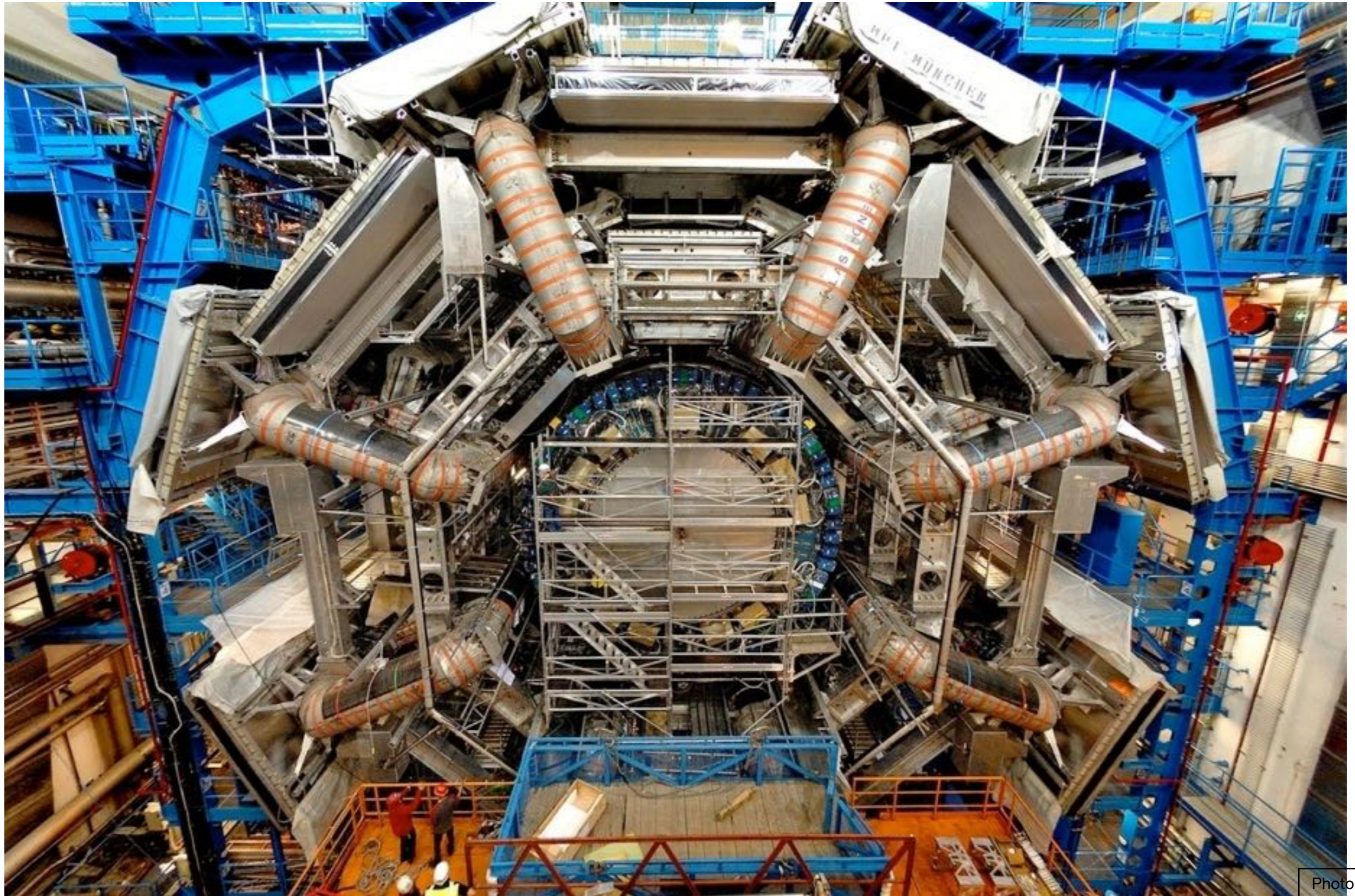

Photo: CERN



Basics of Particle Detection: Interaction with Matter



Energy Loss in Matter: Bethe-Bloch

- The Bethe-Bloch Formula describes energy loss by ionization

$$-\frac{dE}{dx} = K z^2 \frac{Z}{A} \frac{1}{\beta^2} \left[\frac{1}{2} \ln \frac{2m_e c^2 \beta^2 \gamma^2 T_{\max}}{I^2} - \beta^2 - \frac{\delta}{2} \right]$$

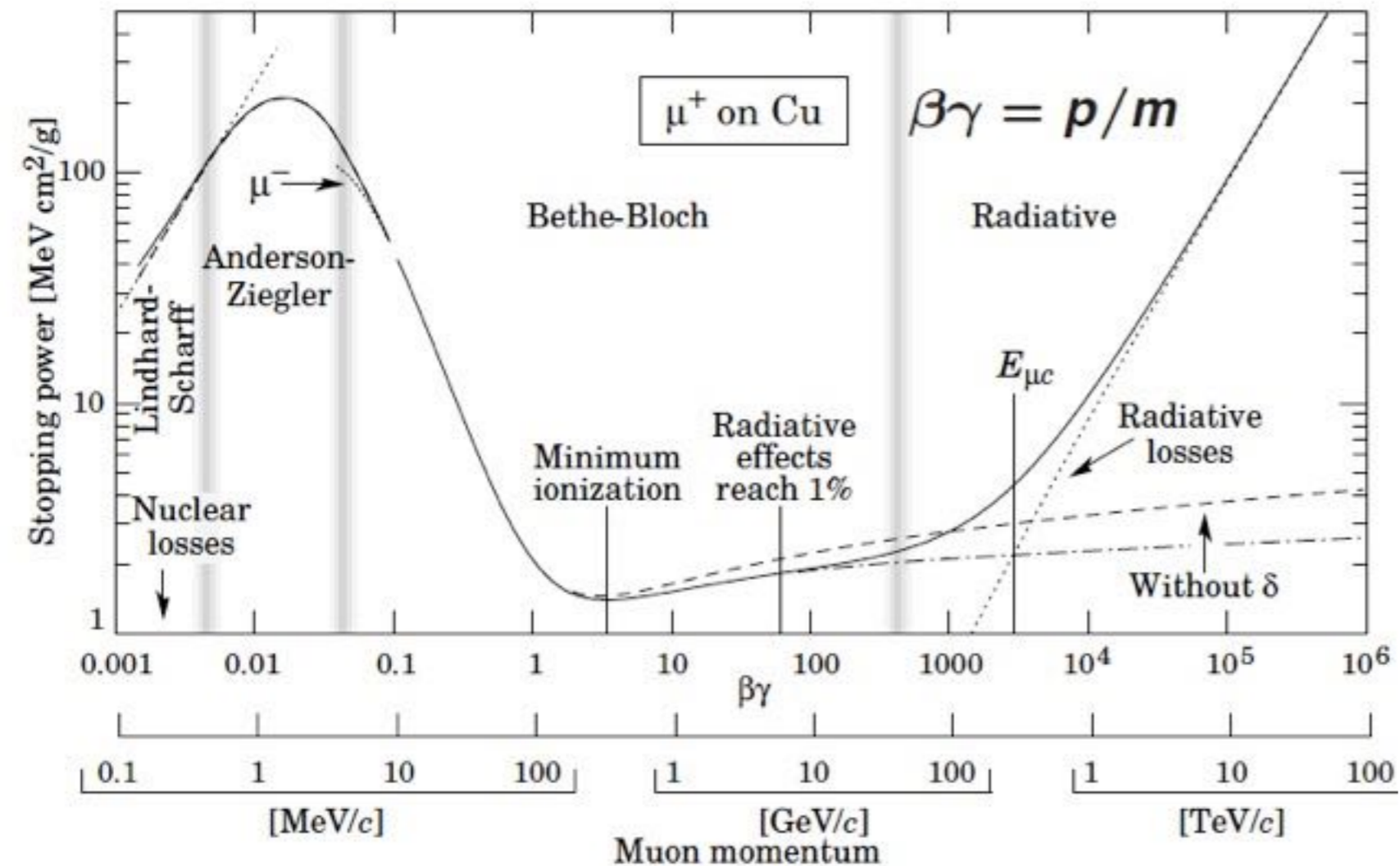

- Applicable in intermediate energy range
 - Atomic effects at low energies and Bremsstrahlung at high energies separately
- Z/A dependence: large energy loss in H**
- 1/β² at low momenta: Heavy particles lose more energy**
- Minimum at p/m ~ 3-4: minimum ionizing particle MIP
- logarithmic rise for high momentum**
- Density effect due to polarization of medium**

Material Dependence of Energy Loss

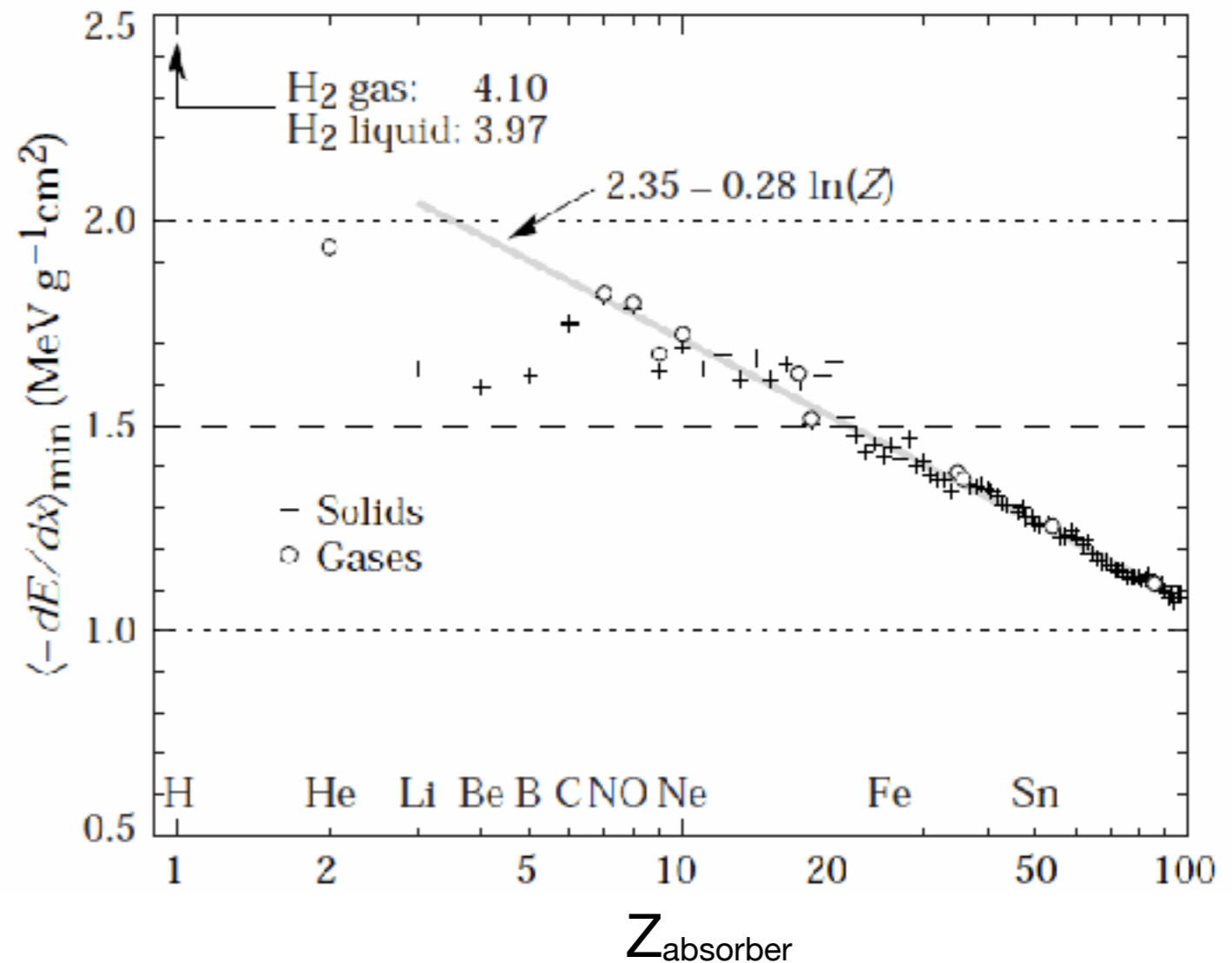
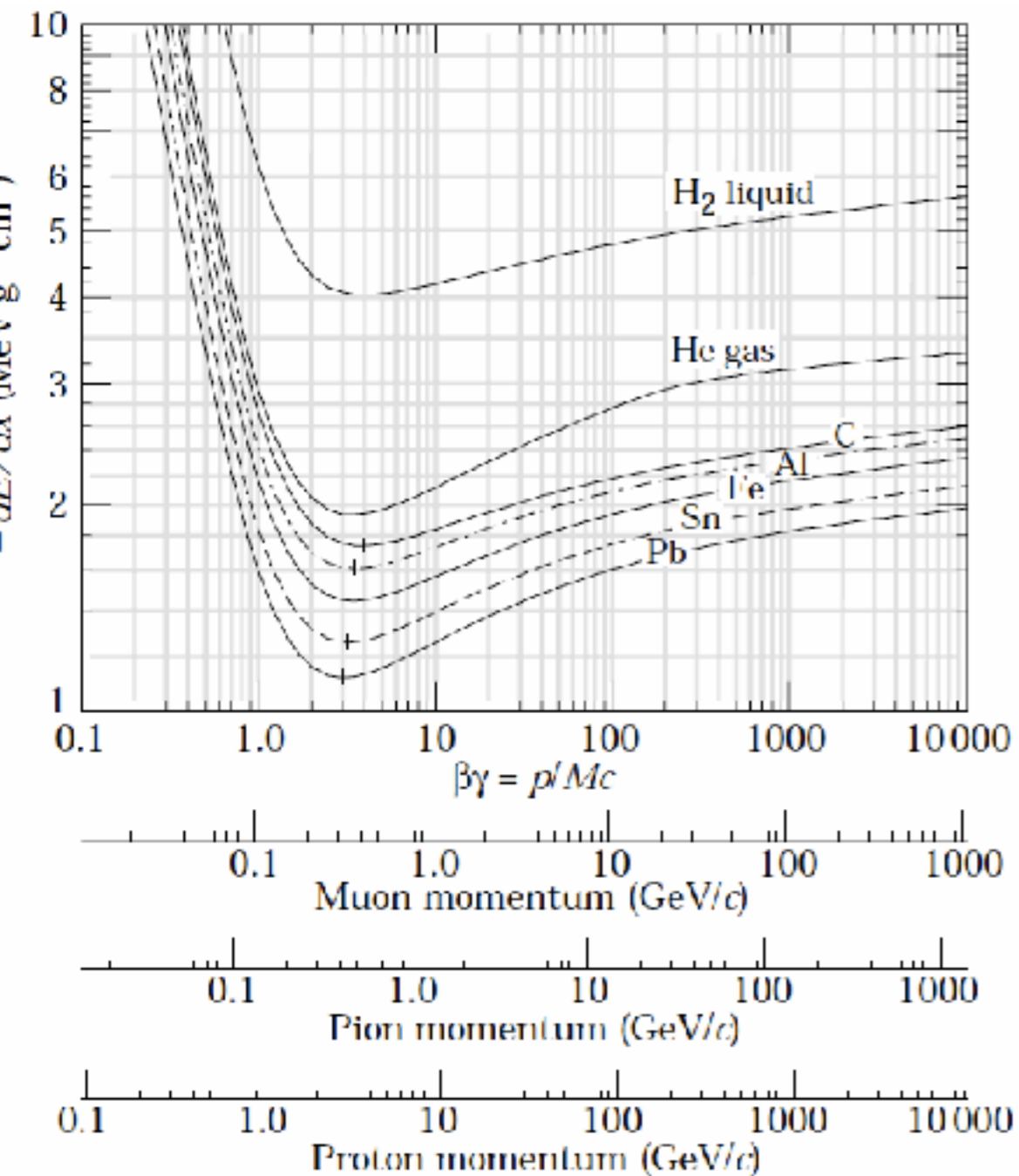

- Simple approximation: Energy loss of MIPs ($\beta\gamma \sim 3$):
1-2 $\text{MeV g}^{-1} \text{cm}^2$ (exception: H)

Energy Loss: A Closer Look

- Bethe-Bloch only gives the mean value!
- ▶ Energy loss is a statistical process

Energy Loss: A Closer Look

- Bethe-Bloch only gives the mean value!
- ▶ Energy loss is a statistical process

On the microscopic level: discrete scatterings, leading to ionization

⇒ Depending on the momentum transfer, a single or multiple free electrons are created

Energy Loss: A Closer Look

- Bethe-Bloch only gives the mean value!
- ▶ Energy loss is a statistical process

On the microscopic level: discrete scatterings, leading to ionization

- ⇒ Depending on the momentum transfer, a single or multiple free electrons are created
- ⇒ Distinguishing primary and secondary ionization:

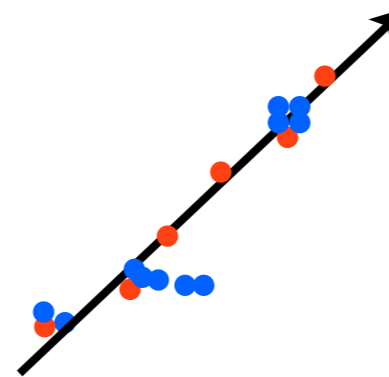
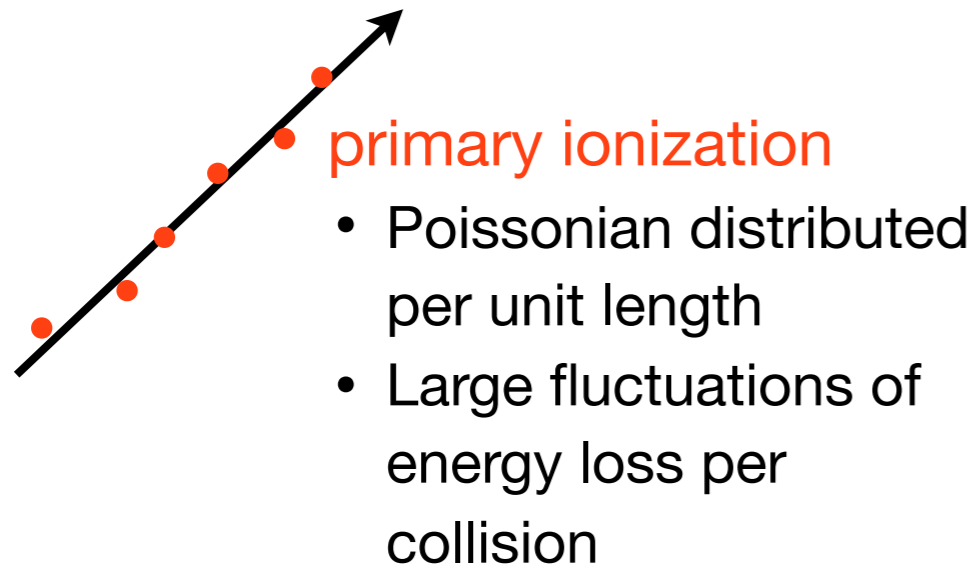

secondary ionization

- ▶ originating from high-energy primary electrons
- ▶ Sometimes the energy is sufficient for a clearly visible secondary track: δ electron

Energy Loss: A Closer Look

- Bethe-Bloch only gives the mean value!
- ▶ Energy loss is a statistical process

On the microscopic level: discrete scatterings, leading to ionization

- ⇒ Depending on the momentum transfer, a single or multiple free electrons are created
- ⇒ Distinguishing primary and secondary ionization:

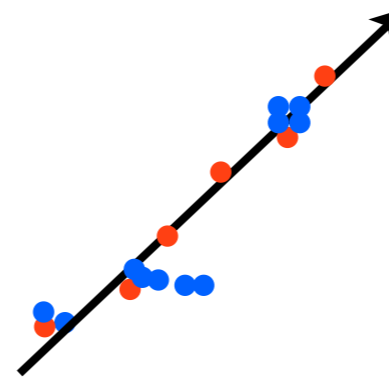
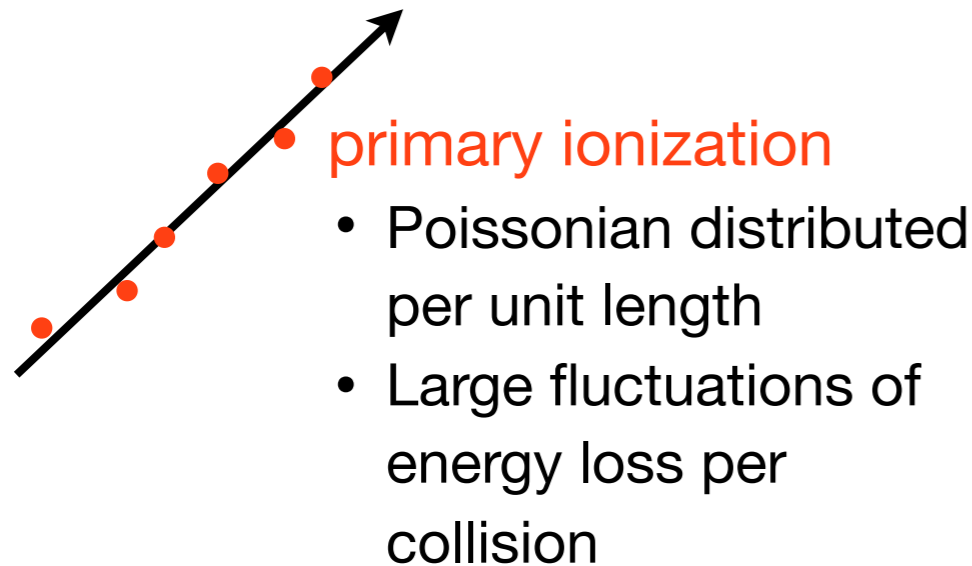

secondary ionization

- ▶ originating from high-energy primary electrons
- ▶ Sometimes the energy is sufficient for a clearly visible secondary track: δ electron

total ionization = **primary ionization** + **secondary ionization**

In gases (STP) typically 30 primary reactions per cm, 90 electrons per cm

Energy Loss: A Closer Look



- Example for a delta electron in a bubble chamber: clearly visible range!

Energy Loss in Thin Layers

- The large range of the energy loss in individual reactions results in large variations of the energy loss in thin detectors:
 - A broad maximum: Collisions with relatively small energy loss
 - A long tail to high energy loss: few collisions with large energy loss, δ electrons

Energy Loss in Thin Layers

- The large range of the energy loss in individual reactions results in large variations of the energy loss in thin detectors:
 - A broad maximum: Collisions with relatively small energy loss
 - A long tail to high energy loss: few collisions with large energy loss, δ electrons

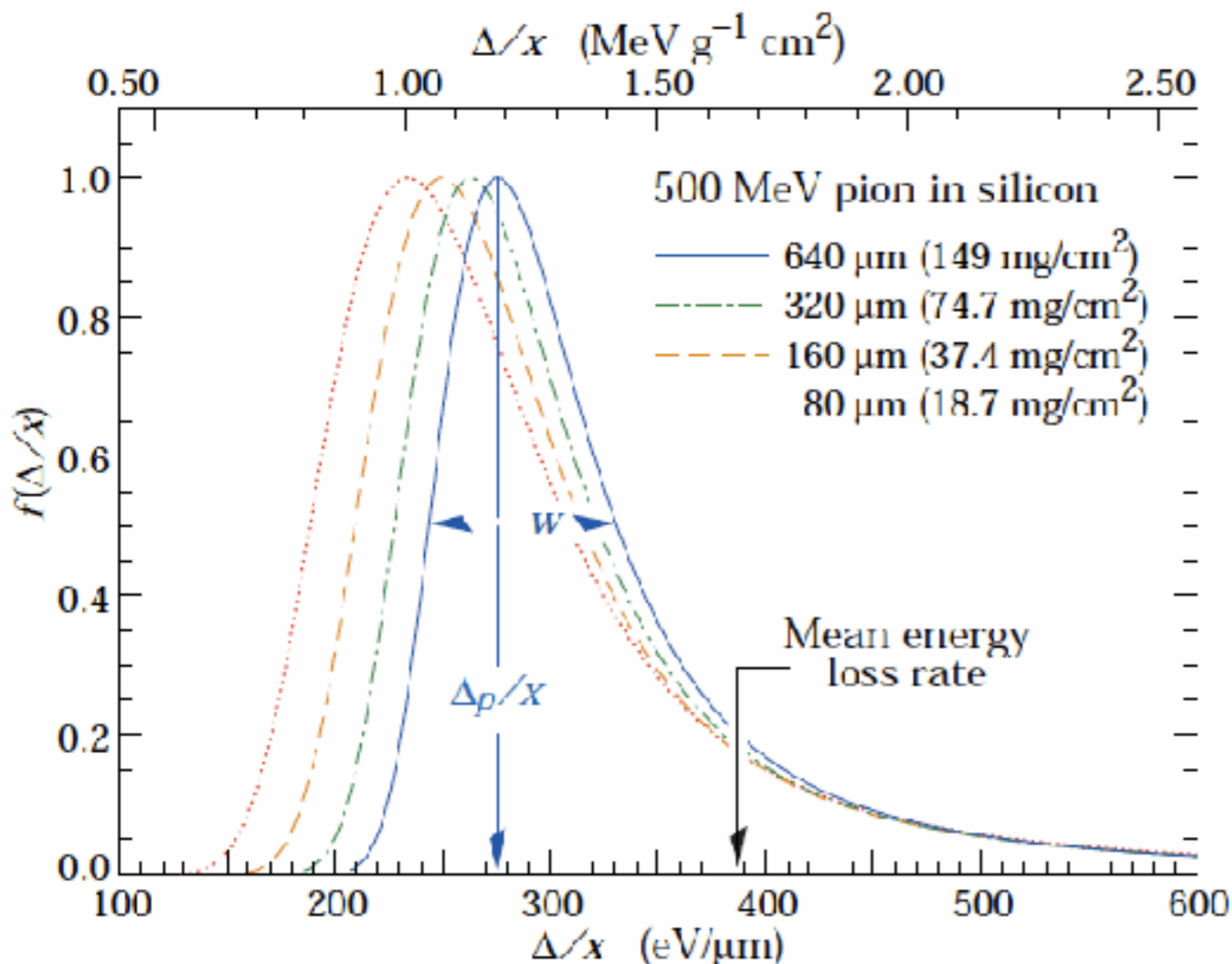

The energy loss in thin layers was first described by Landau:

Landau distribution

Thin absorber:

$$\langle \Delta E \rangle < \sim 10 T_{\max}$$

For 500 MeV pions: $T_{\max} \sim 9$ MeV
(Mean energy loss in 9 mm of Si)

Photons: Interactions

photo effect

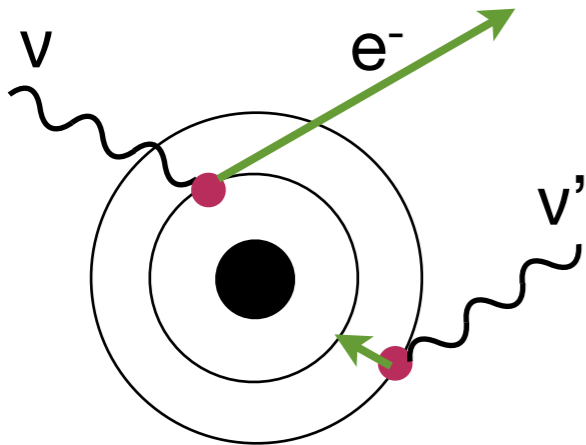

Compton scattering

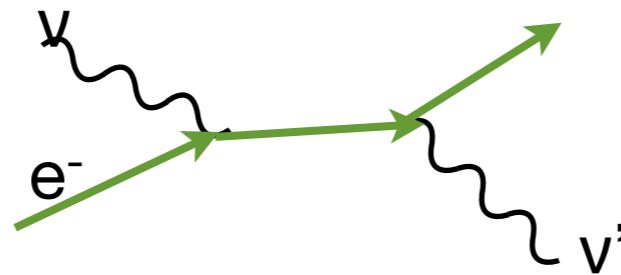

pair creation

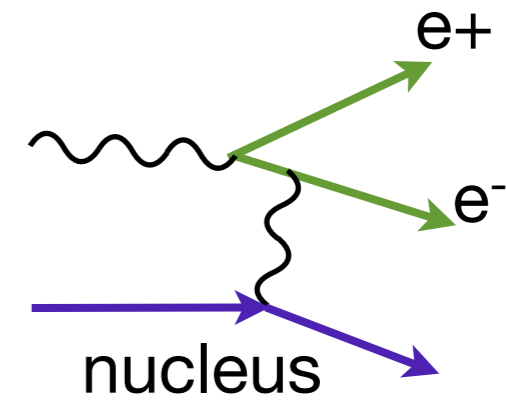

energy threshold:
 $2 m_e = \sim 1.022 \text{ MeV}$

Photons: Interactions

photo effect

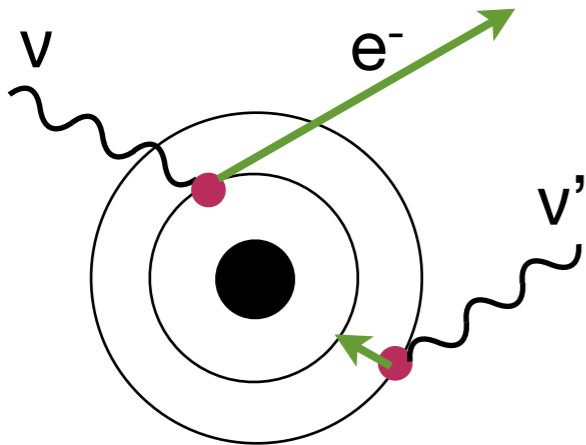

Compton scattering

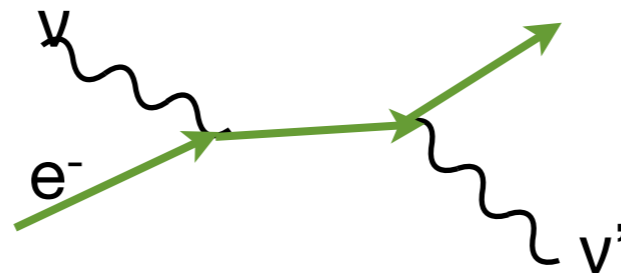

pair creation

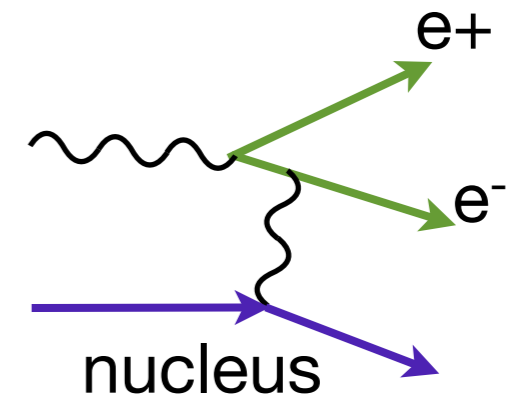

energy threshold:
 $2 m_e = \sim 1.022 \text{ MeV}$

- In contrast to dE/dx for charged particles:
“All or nothing” reactions

Photons: Interactions

photo effect

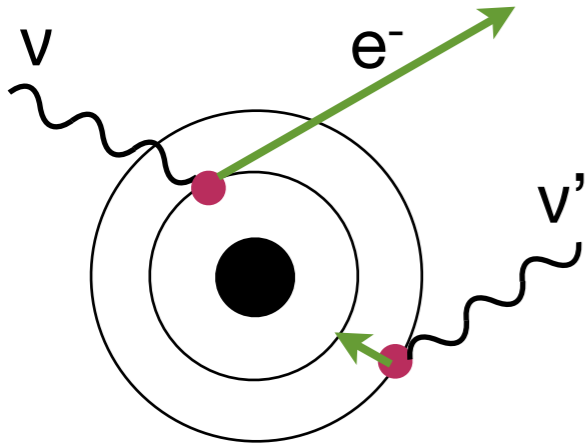

Compton scattering

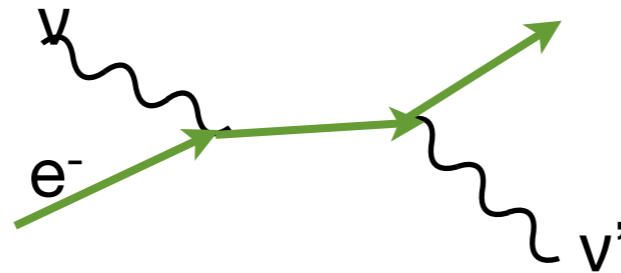

pair creation

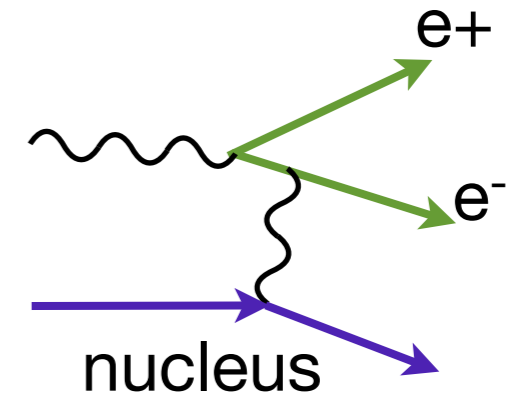

energy threshold:
 $2 m_e = \sim 1.022 \text{ MeV}$

- In contrast to dE/dx for charged particles:
“All or nothing” reactions

⇒ Reduction of photon intensity when traversing matter:

$$I(x) = I_0 e^{-\mu x}$$

Photons in Matter

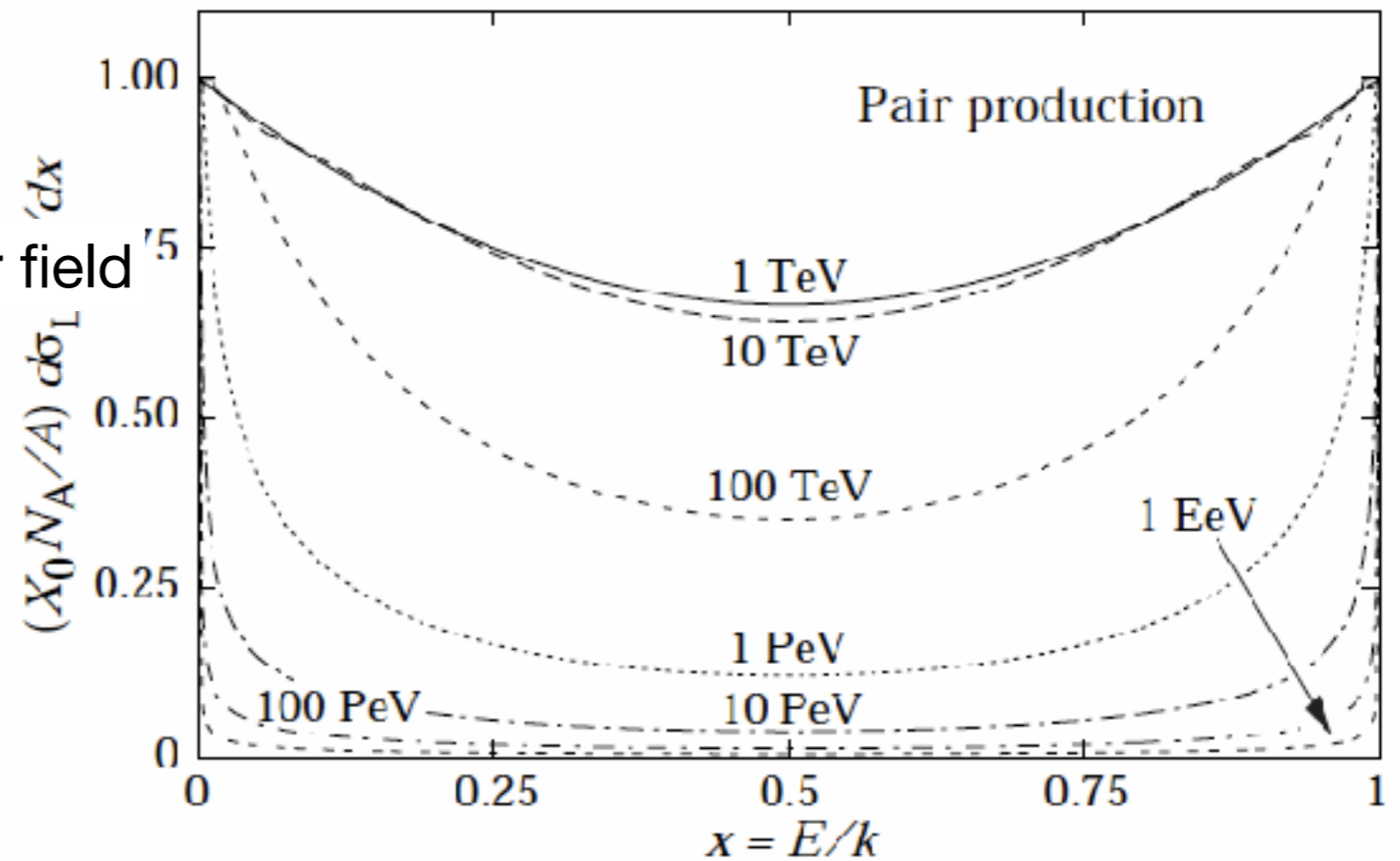
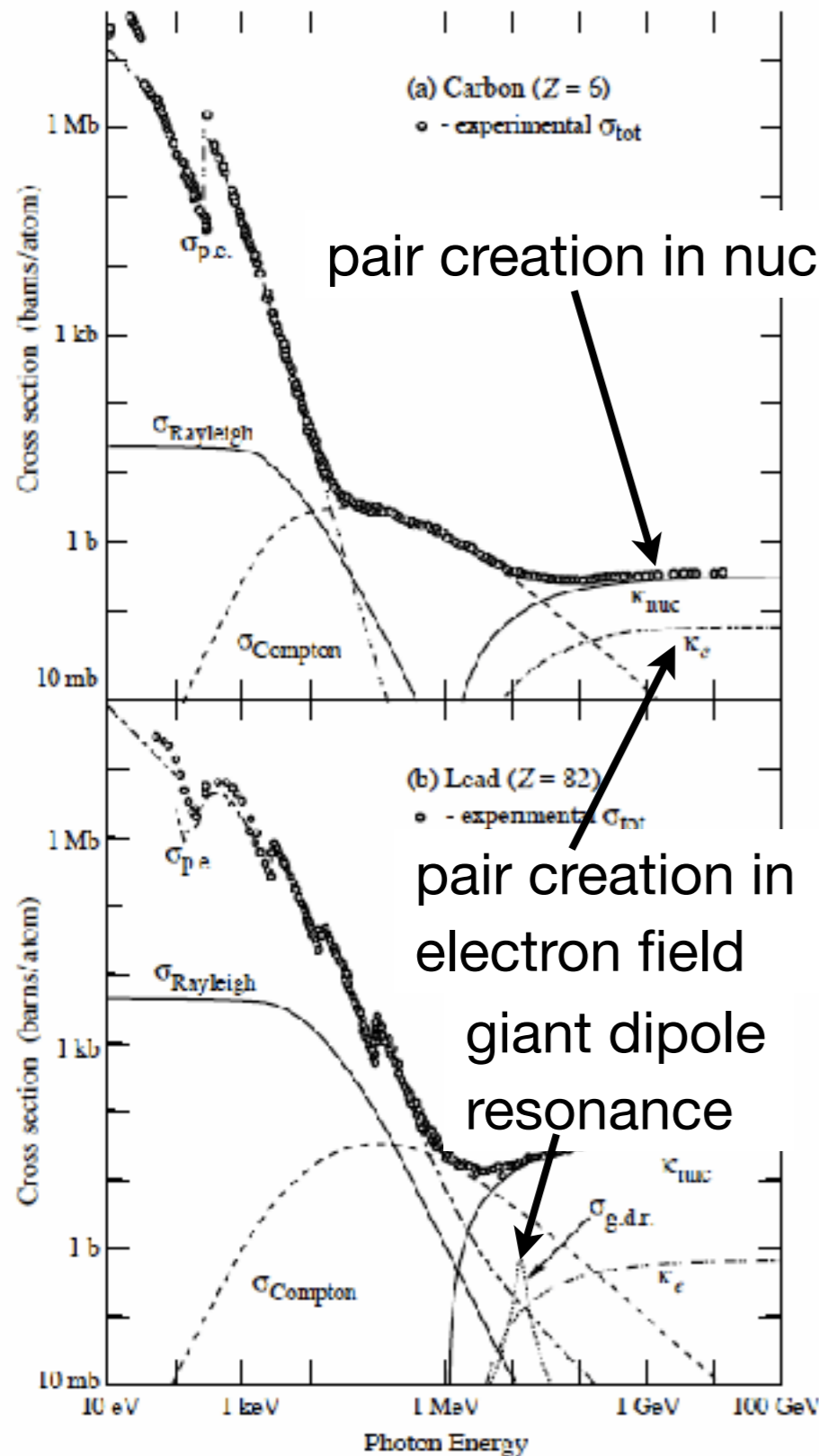

- At high energies pair creation dominates by far
- Low energies:
 - photoelectric effect
 - Coherent scattering: Rayleigh scattering
 - Compton scattering
 - nuclear excitation

Electrons: Energy Loss

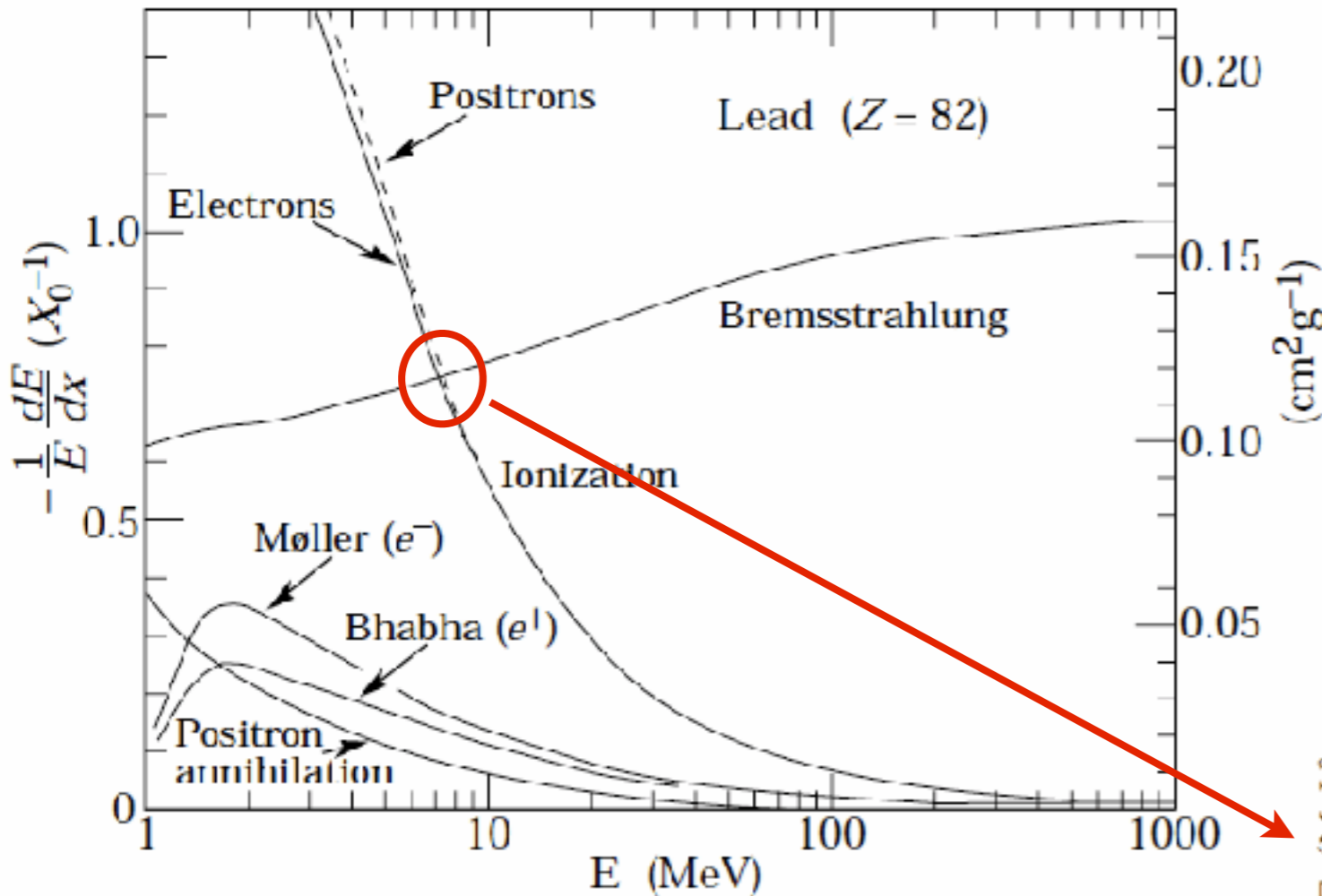

- Bremsstrahlung dominates at high energies
- At low energy: Ionization, scattering

- Critical energy: The energy where ionization energy loss equals radiative losses through Bremsstrahlung

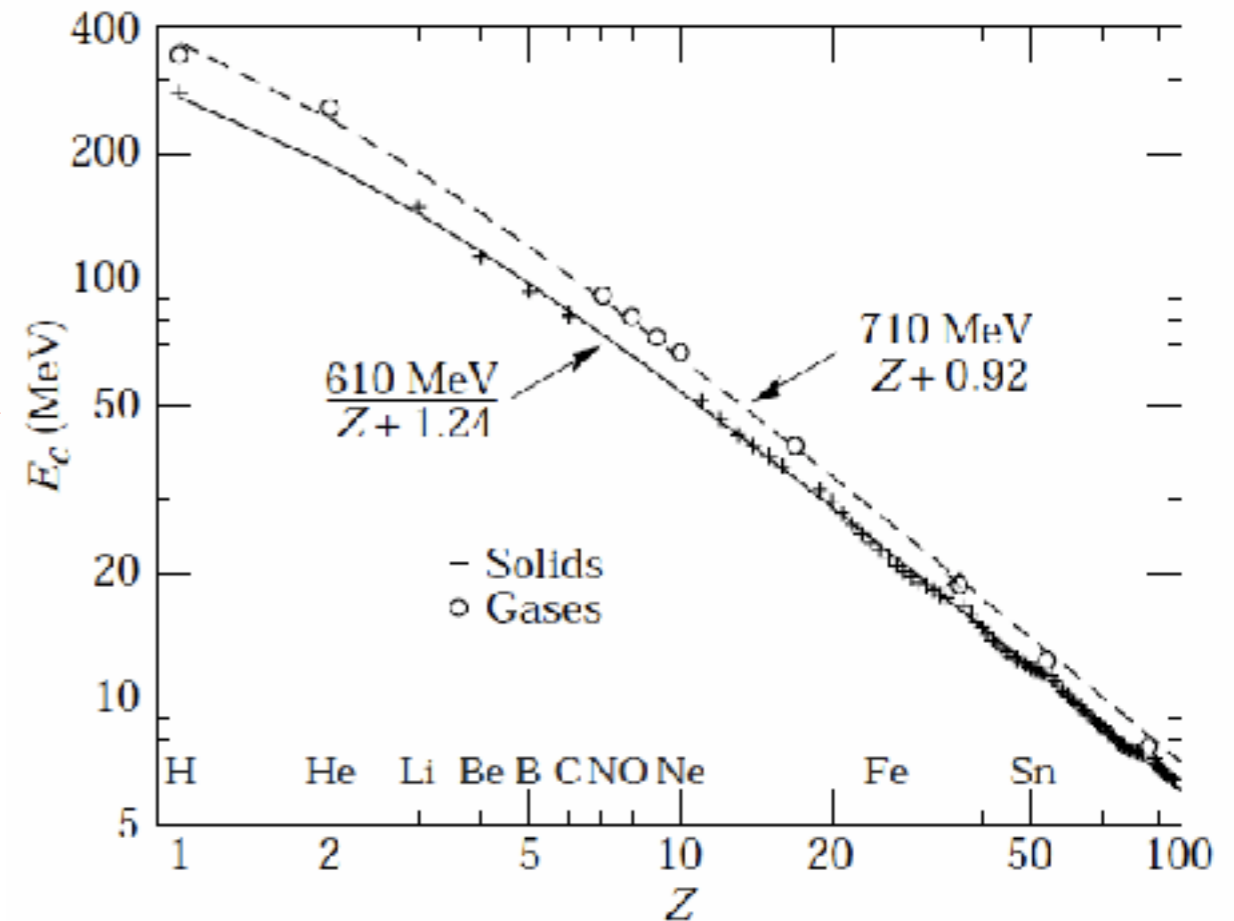

Electrons and Photons: Radiation Length

- The relevant length scale: one radiation length
 - Describes high-energy electrons and photons (Energy loss via Bremsstrahlung and e^+e^- - pair creation, respectively)

Electrons and Photons: Radiation Length

- The relevant length scale: one radiation length
 - Describes high-energy electrons and photons (Energy loss via Bremsstrahlung and e^+e^- - pair creation, respectively)
 - Defined as the amount of matter that has to be traversed such that
 - an electron loses all but $1/e$ of its energy via Bremsstrahlung
 - $7/9$ of the mean free path for pair creation for high-energy photons

Electrons and Photons: Radiation Length

- The relevant length scale: one radiation length
 - Describes high-energy electrons and photons (Energy loss via Bremsstrahlung and. e^+e^- - pair creation, respectively)
 - Defined as the amount of matter that has to be traversed such that
 - an electron loses all but 1/e of its energy via Bremsstrahlung
 - 7/9 of the mean free path for pair creation for high-energy photons

empirical:
$$X_0 = \frac{716.4 A}{Z(1+Z) \ln(287/\sqrt{Z})} \frac{g}{cm^2} \propto \frac{A}{Z^2}$$

Electrons and Photons: Radiation Length

- The relevant length scale: one radiation length
 - Describes high-energy electrons and photons (Energy loss via Bremsstrahlung and. e^+e^- - pair creation, respectively)
 - Defined as the amount of matter that has to be traversed such that
 - an electron loses all but 1/e of its energy via Bremsstrahlung
 - 7/9 of the mean free path for pair creation for high-energy photons

empirical:
$$X_0 = \frac{716.4 A}{Z(1+Z) \ln(287/\sqrt{Z})} \frac{g}{cm^2} \propto \frac{A}{Z^2}$$

- Also relevant for the description of multiple coulomb scattering

Electrons and Photons: Radiation Length

- The relevant length scale: one radiation length
 - Describes high-energy electrons and photons (Energy loss via Bremsstrahlung and. e^+e^- - pair creation, respectively)
 - Defined as the amount of matter that has to be traversed such that
 - an electron loses all but 1/e of its energy via Bremsstrahlung
 - 7/9 of the mean free path for pair creation for high-energy photons

empirical:
$$X_0 = \frac{716.4 A}{Z(1+Z) \ln(287/\sqrt{Z})} \frac{g}{cm^2} \propto \frac{A}{Z^2}$$

- Also relevant for the description of multiple coulomb scattering
- Is usually given in g/cm^2 , typical values:
 - Air: 36.66 g/cm^2 , corresponds to ~ 300 m
 - Water: 36.08 g/cm^2 , corresponds to ~ 36 cm
 - Aluminium: 24.01 g/cm^2 , corresponds to 8.9 cm
 - Tungsten: 6.76 g/cm^2 , corresponds to 0.35 cm

Methods of Particle Detection



Ionization Chamber: A Classic

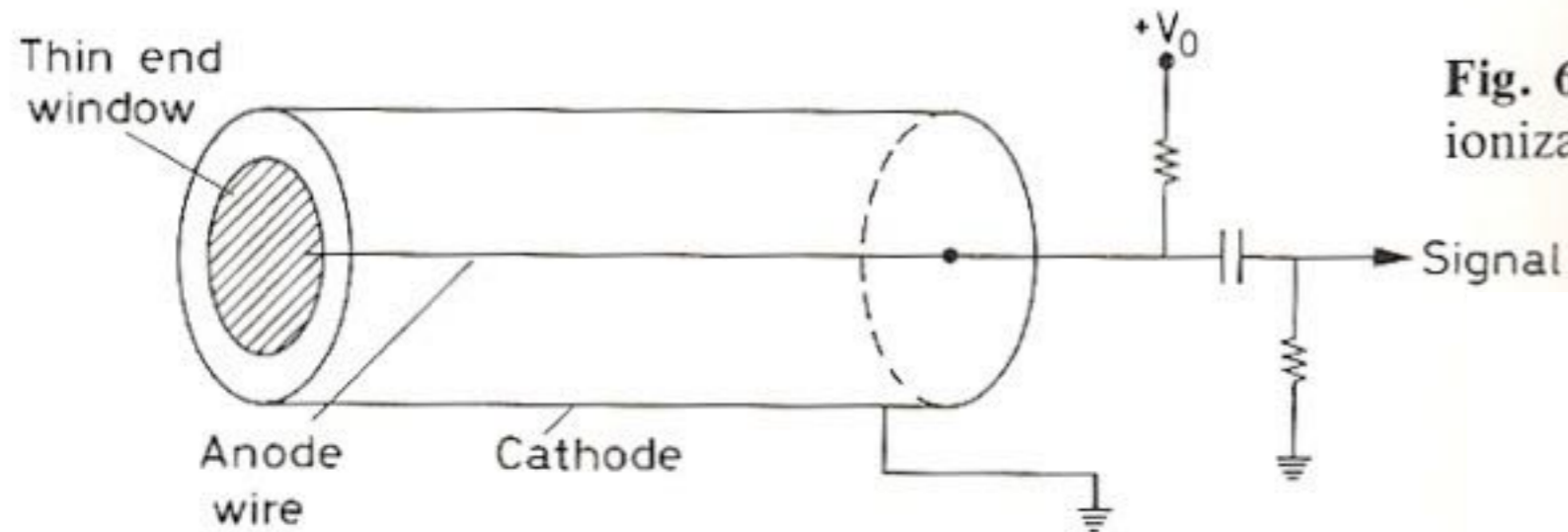
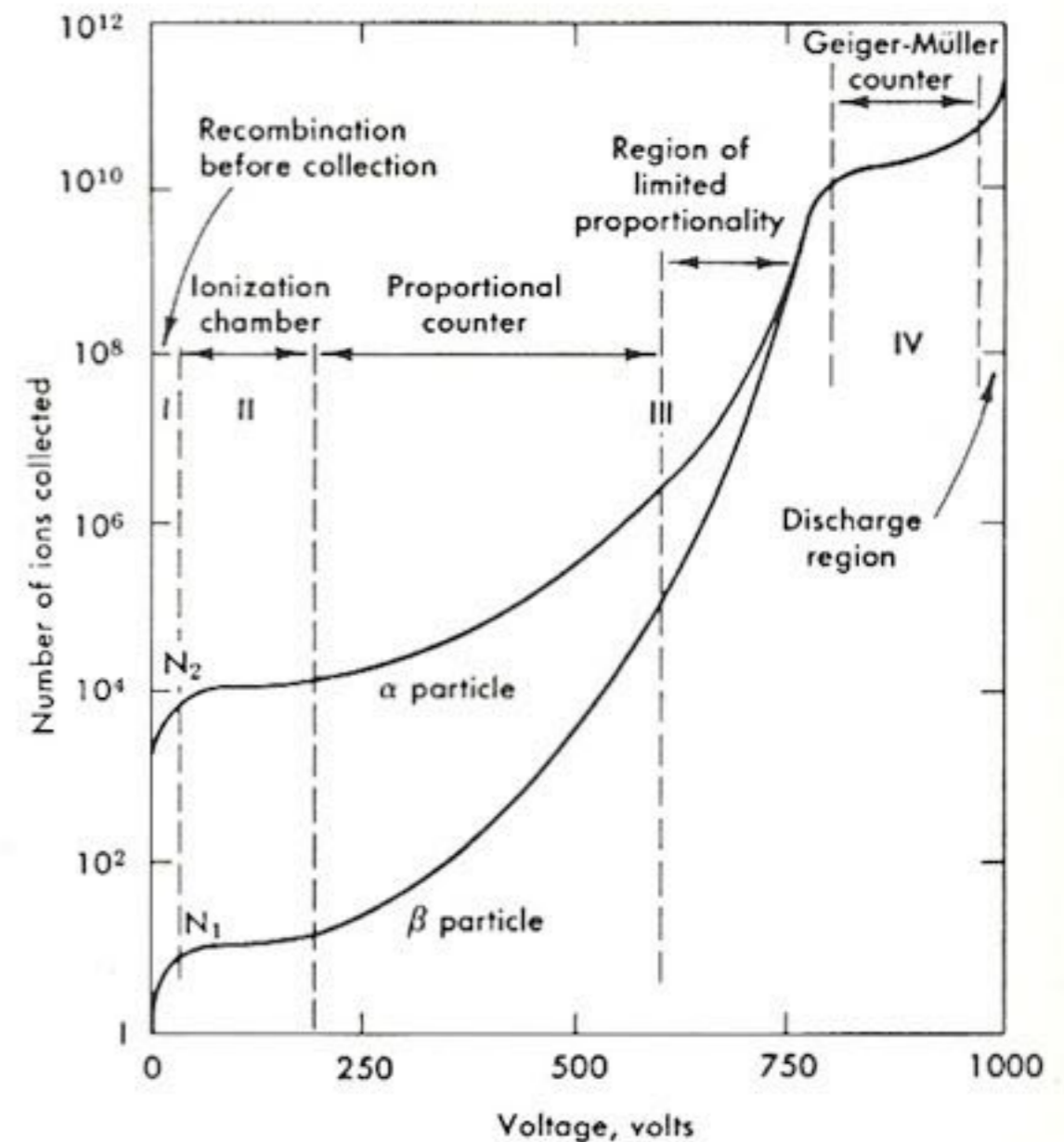
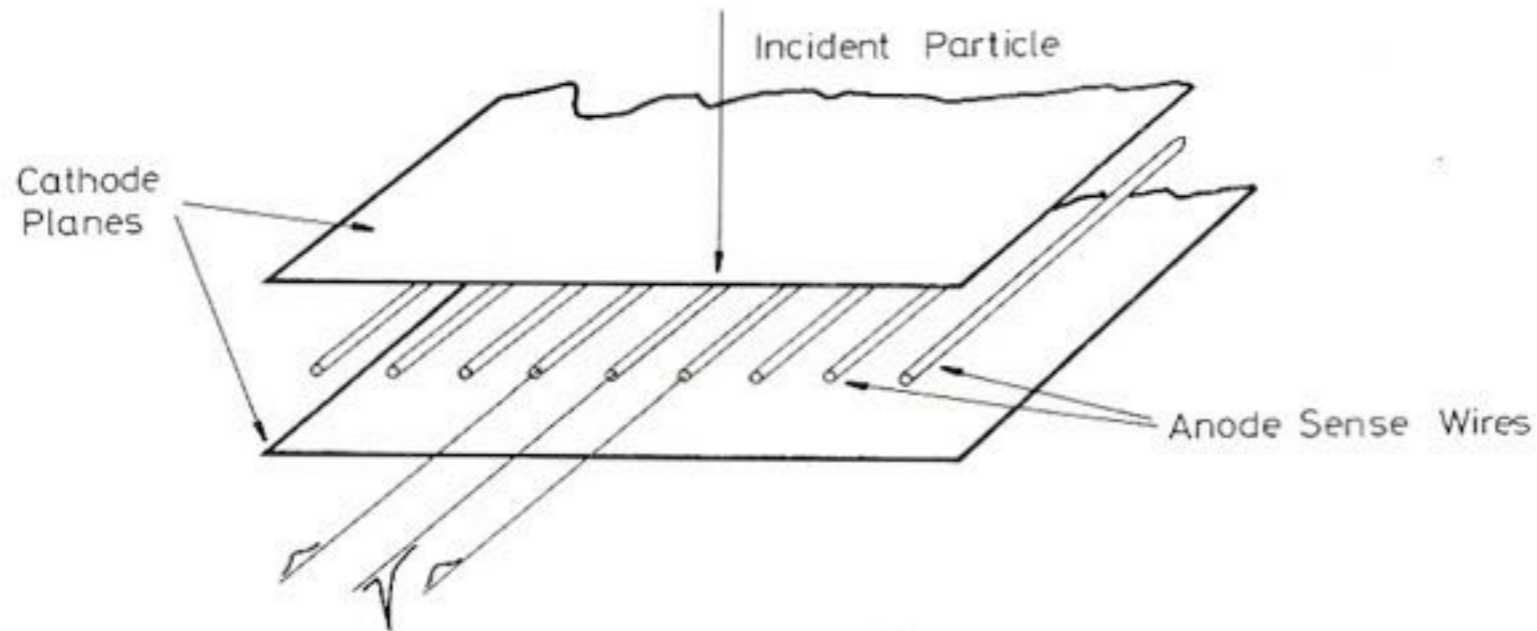

Fig. 6.1. Ionization

- Particles create electron-ion pairs in gas volume
- Electrons are accelerated in strong electric field, resulting in avalanche amplification
- Depending on the applied voltage the signal is proportional to the deposited energy or saturates



Spatial Resolution



- **Multi-Wire Proportional Counter MWPC**
- G. Charpak 1968 (NP 1992)

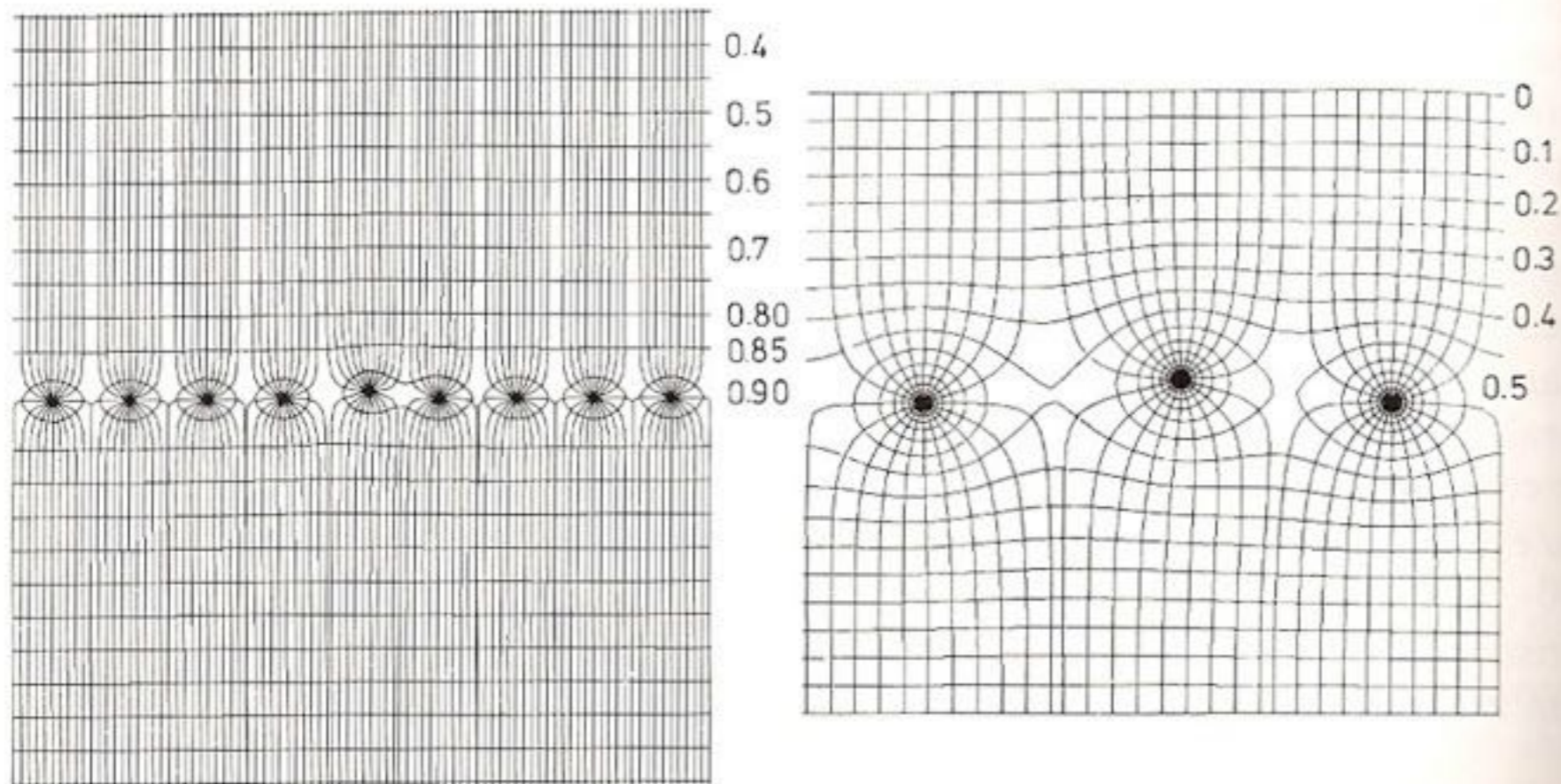

Spatial Information through Timing: Drift Chamber

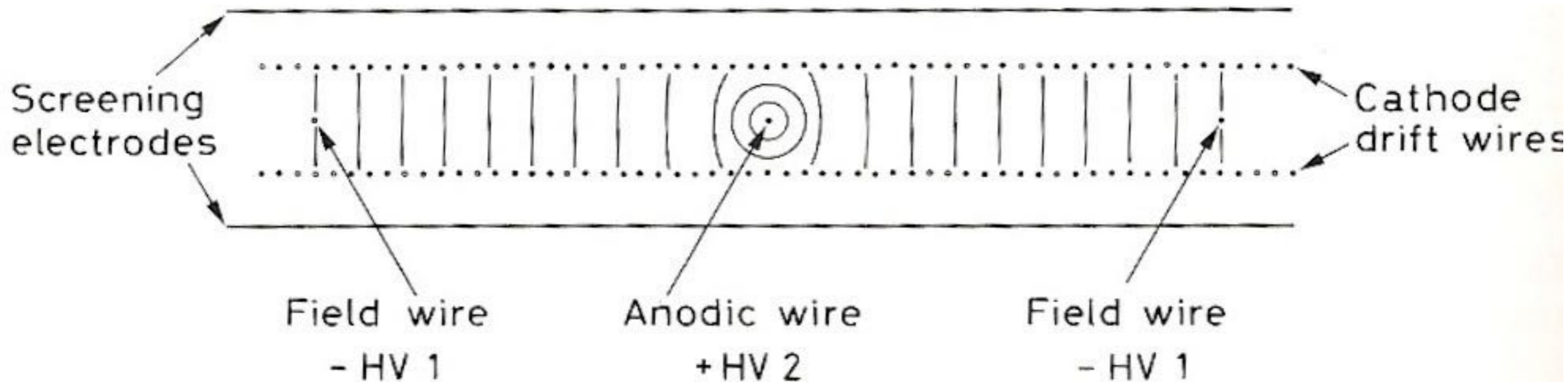
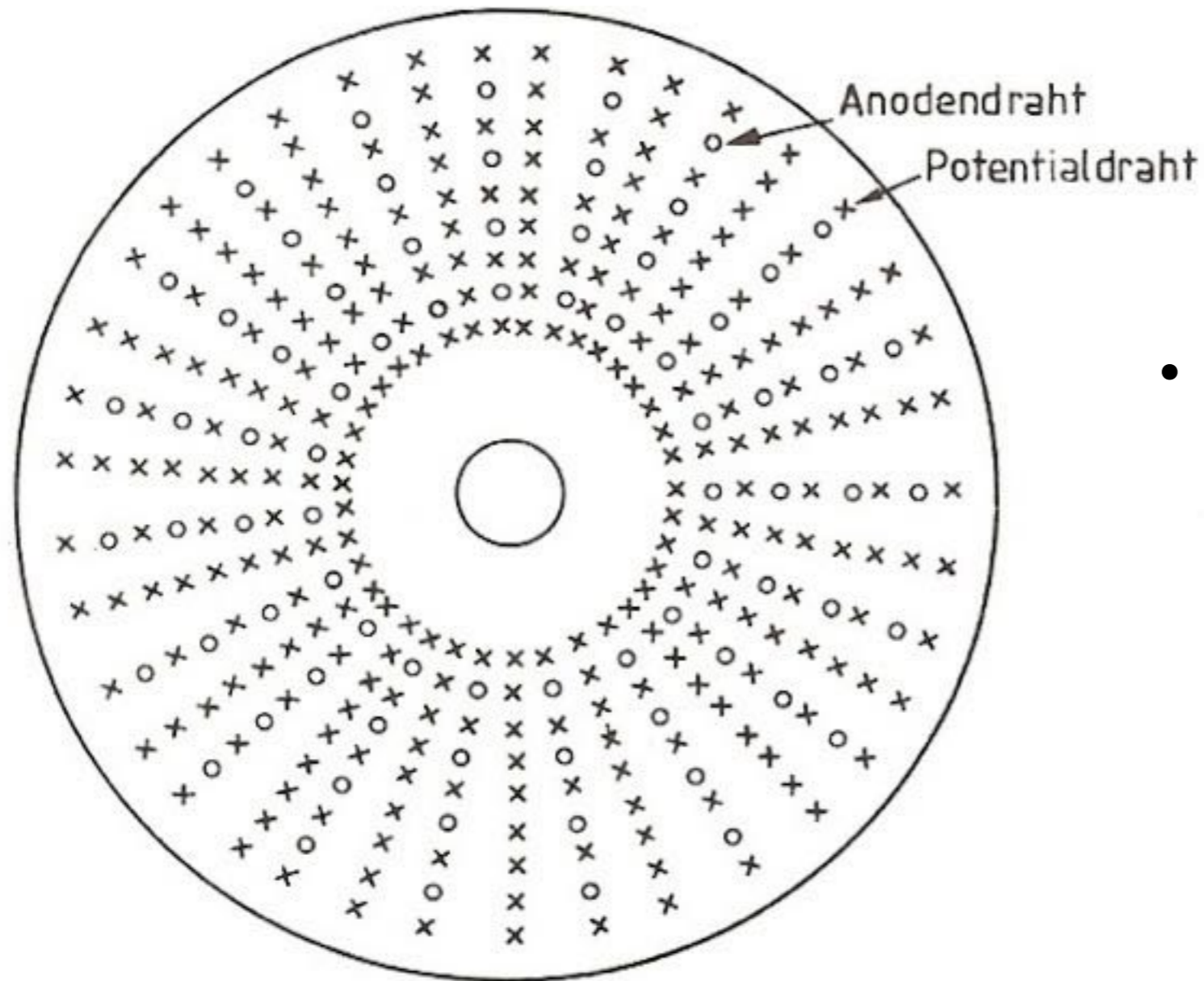

Fig. 6.16. Drift chamber design using interanode field wires (from *Breskin et al.* [6.22])

- If the time of passage of a particle is known from external measurements (trigger!) one can determine the location based on the arrival time of the charge cloud at the anode wire
- Prerequisite: Field distribution, and through that also drift velocity profile in gas volume well known

Cylindrical Drift Chamber for Collider Detectors



- Solenoidal magnetic field for momentum measurement parallel to chamber wires

Abb. 4.41 Prinzipieller Aufbau einer zylindrischen Driftkammer. Die Abbildung zeigt einen Schnitt durch die Kammer senkrecht zu den Drähten.

Semiconductor Detectors: PN Junction

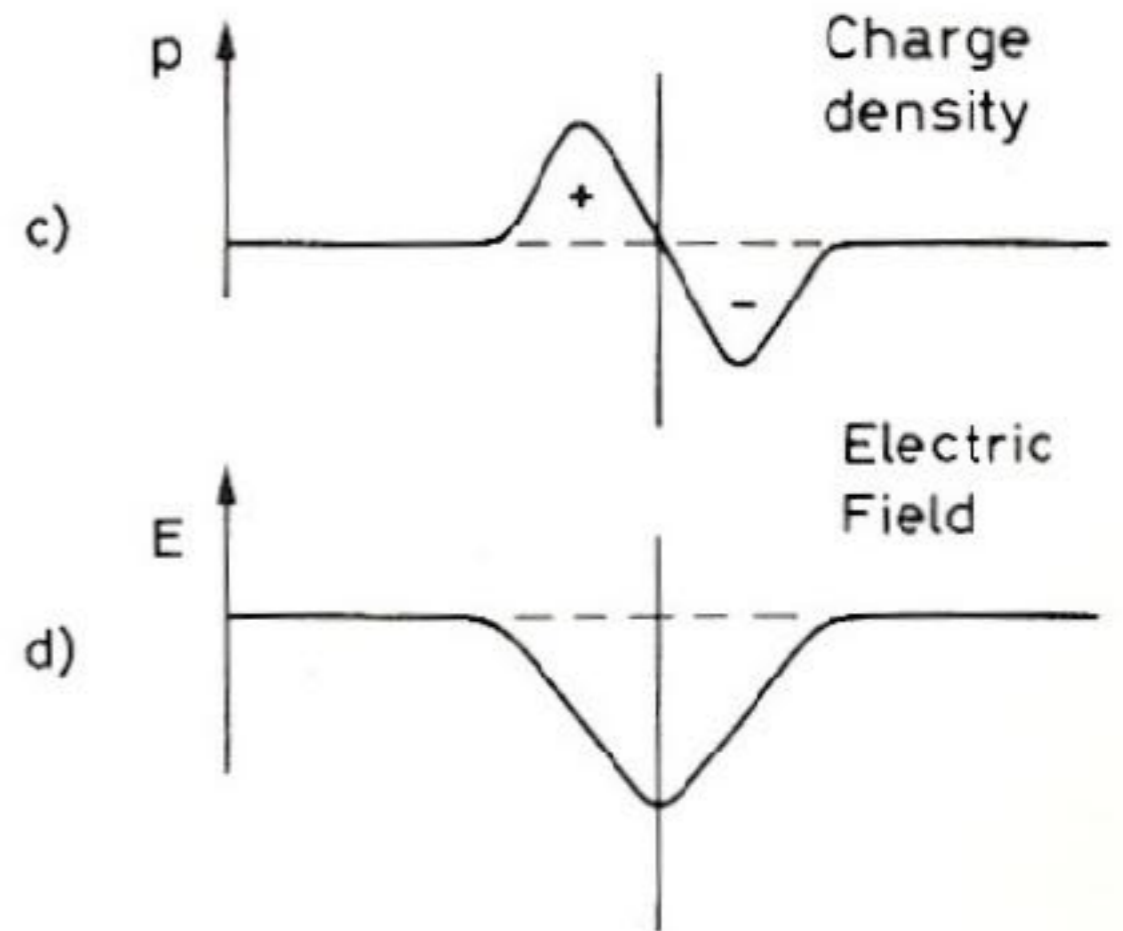
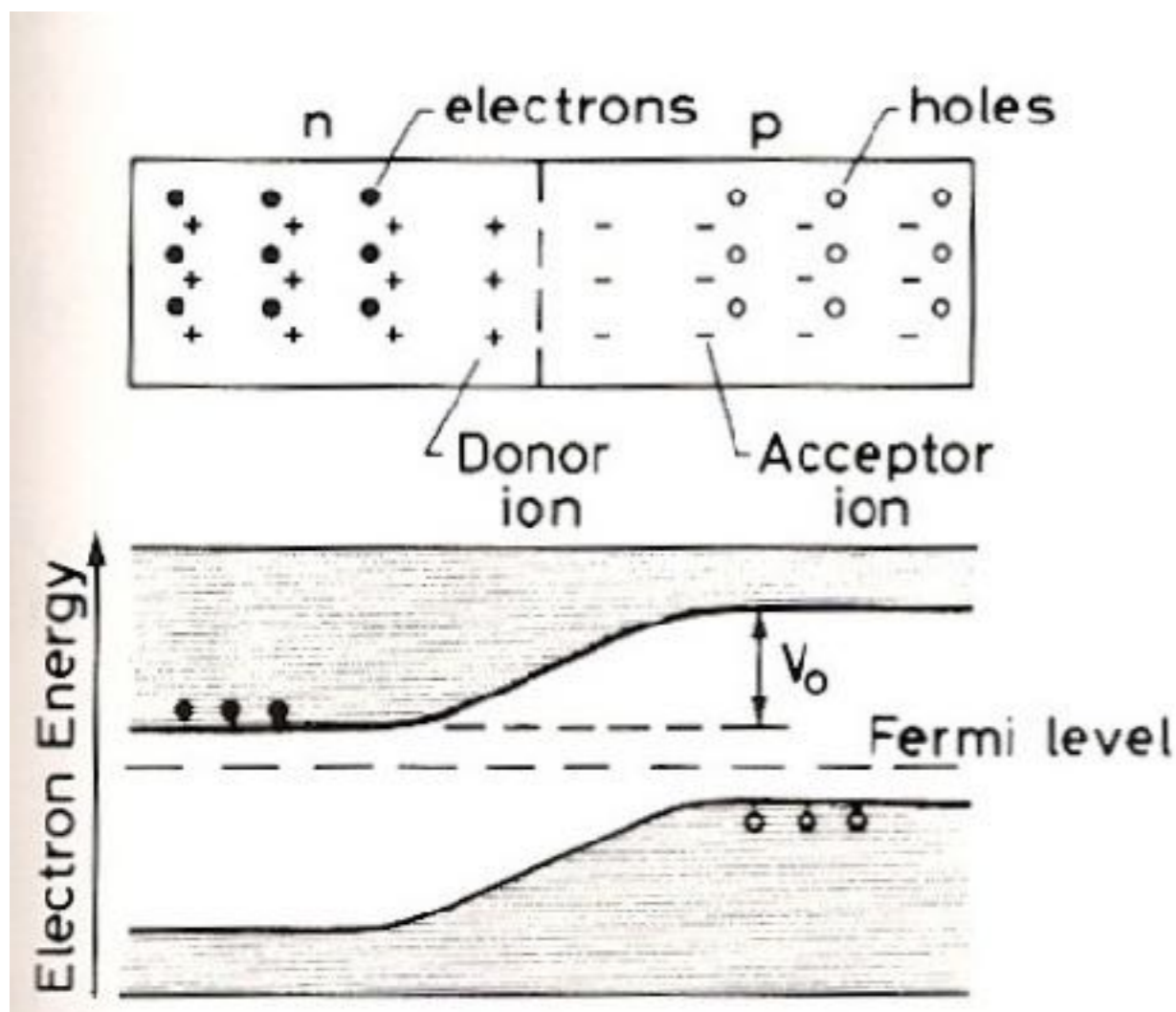

- By combining silicon with different dopants you get a PN junction
 - Donor (e.g. Phosphorus) provides electrons: n-doping
 - Acceptor (e.g. Boron) provides holes: p-doping
 - The charge excess gets neutralized on contact, a depletion zone and a corresponding electric field develops at the junction

Semiconductor Detectors: Charge Collection

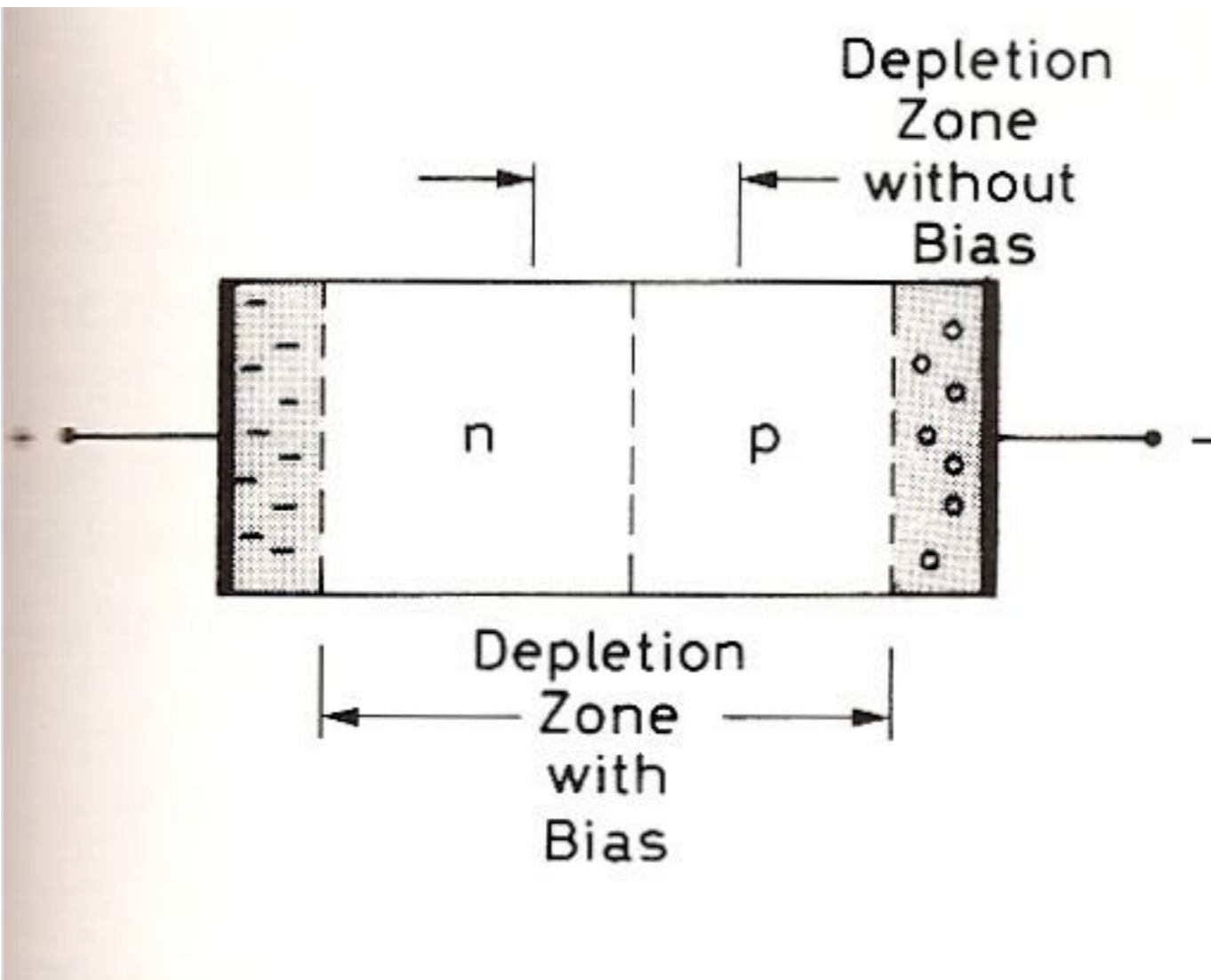

- An external bias voltage increases the depletion zone by removing all charge carriers
- ▶ Created electrons and holes move to the contacts without recombining with the Si: development of a signal

- Through-going particles produce electron-hole pairs (in Si: 3.6 eV required per pair, for comparison: 20 eV - 40 eV in gas)
 - The high density and low ionization threshold allows to build compact detectors with excellent spatial resolution

Semiconductor Strip Detectors

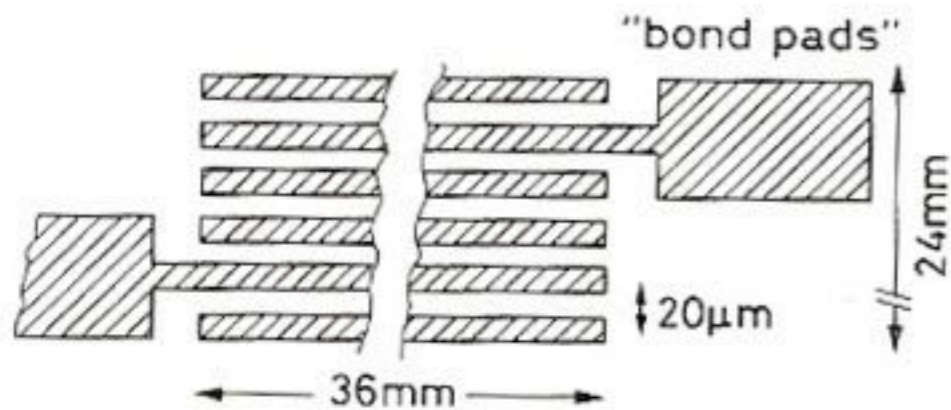
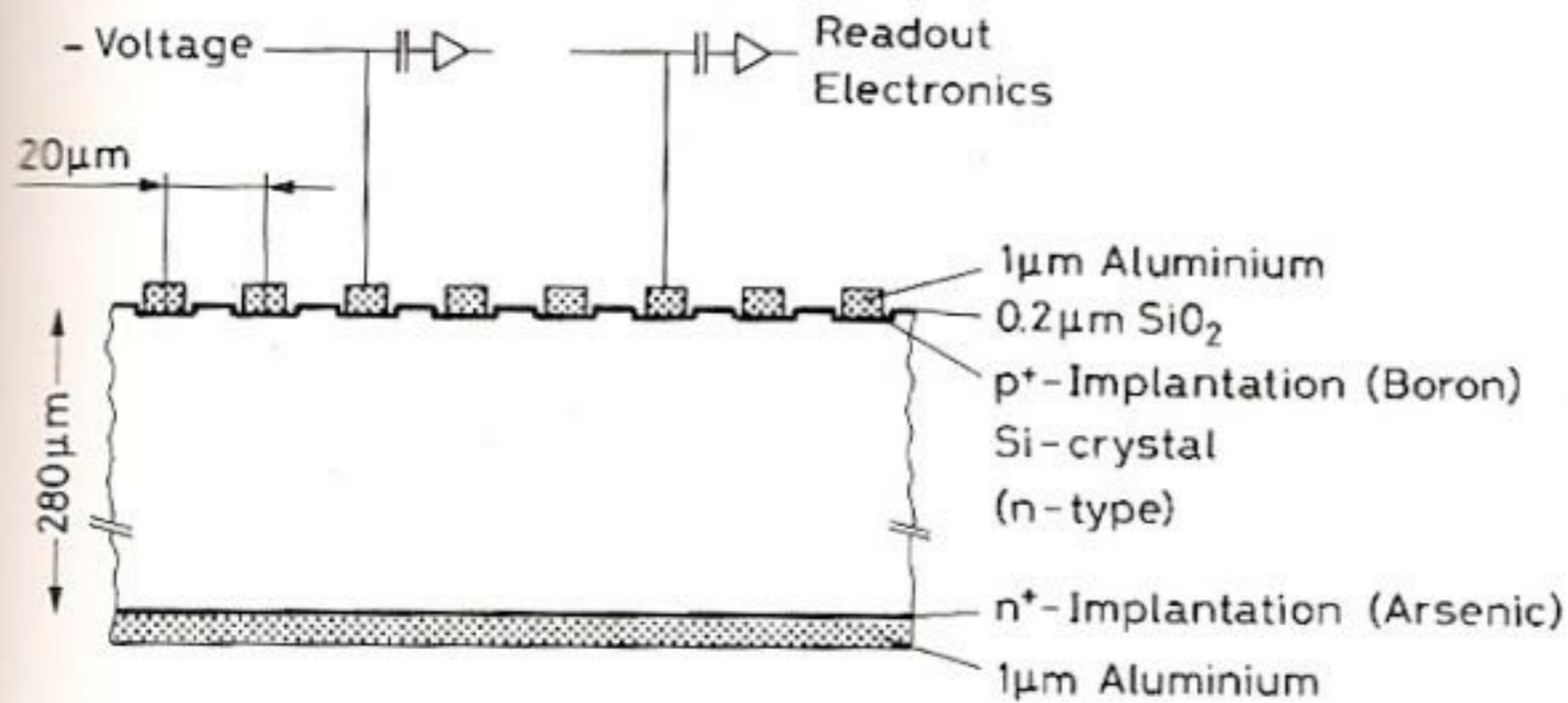
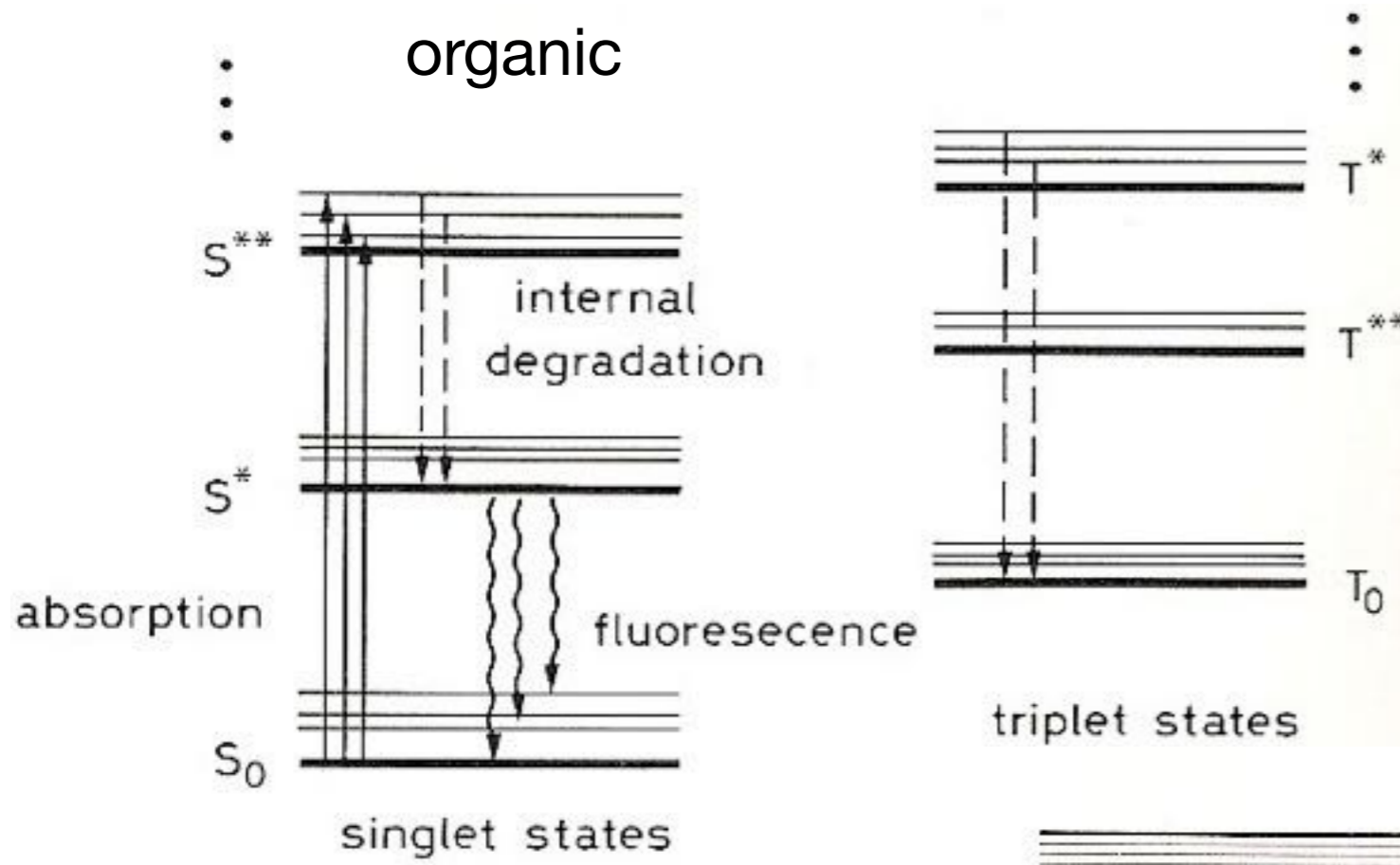

Fig. 10.16. Layout of a micro-strip detector and readout strips (from *Hyams et al.* [10.14])

Scintillators



- Scintillators emit light when traversed by ionizing particles
 - Excitation of metastable states (organic scintillators) or Defects in Crystals (inorganic scintillators)

inorganic:

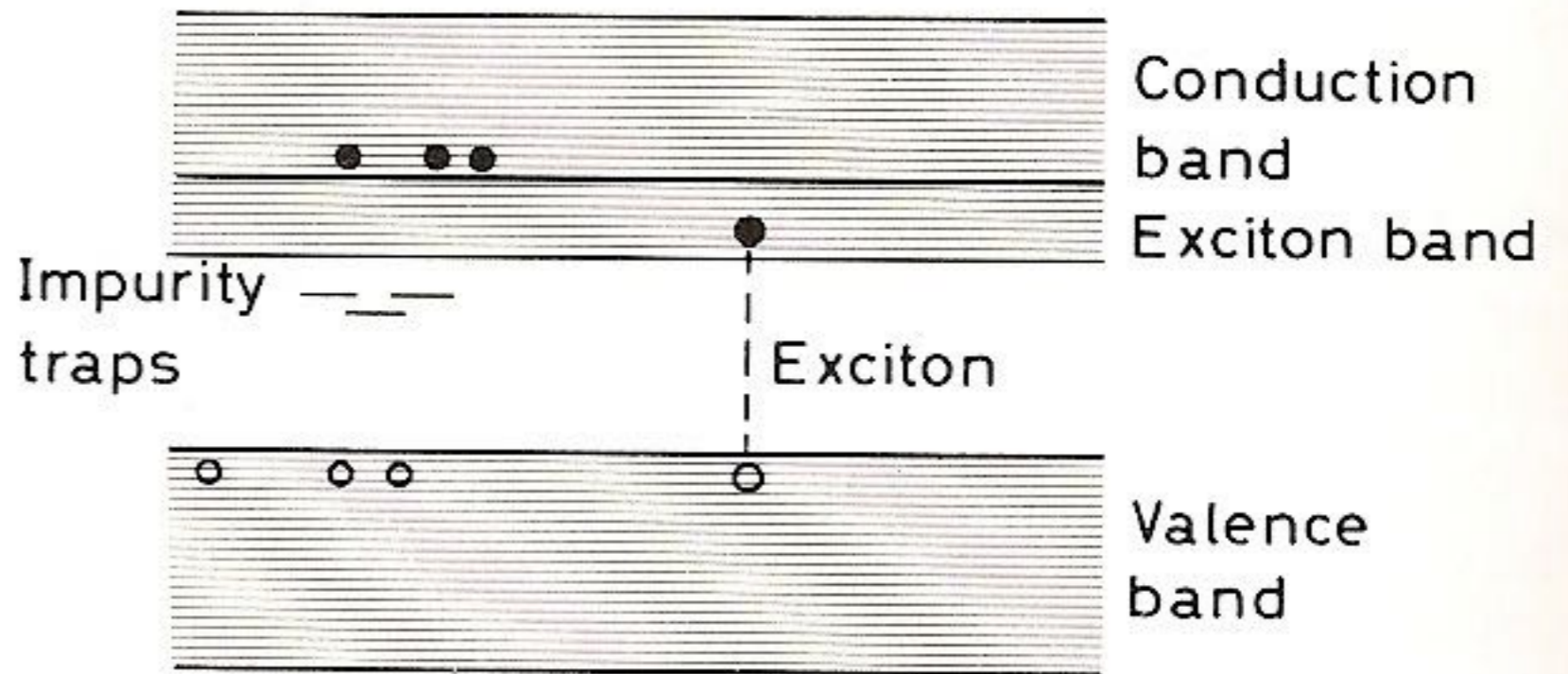

Scintillation Detectors

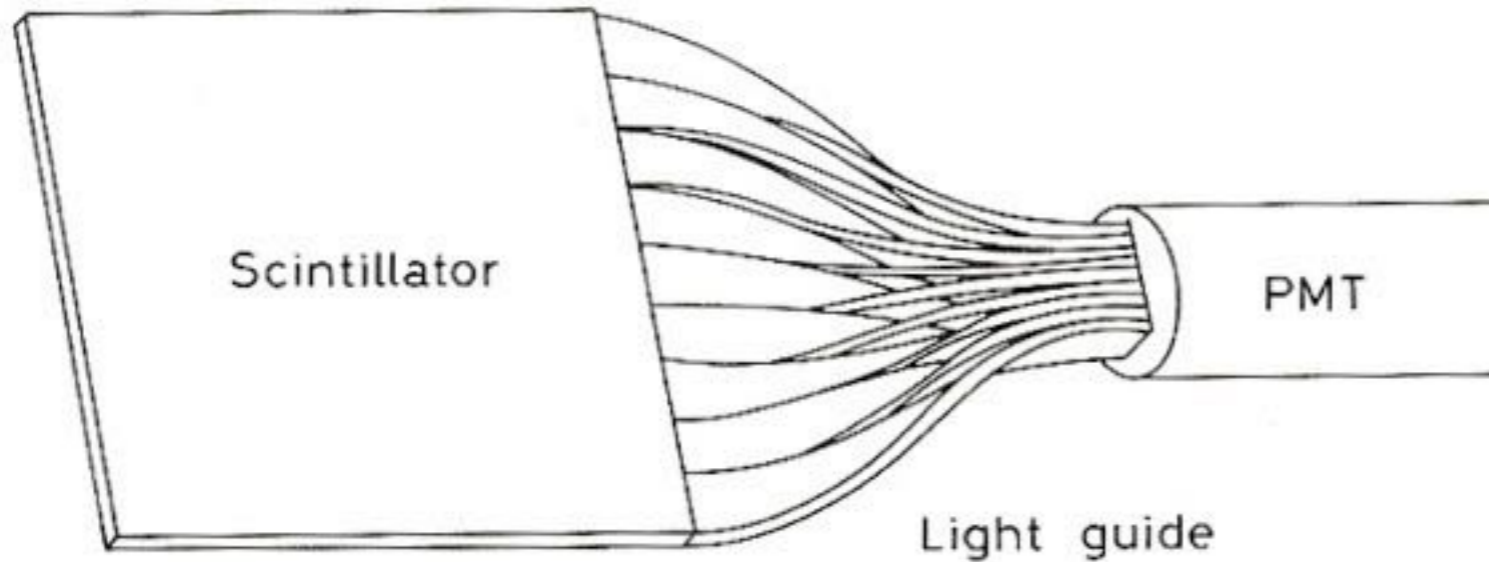

Fig. 9.7. The *twisted* light guide. Many strips of light guide material are glued on to the edge of the scintillator and then twisted 90° so as to fit onto the PM face

- Classical principle: Detection of scintillation light with photo multipliers
 - today these are more and more replaced by silicon-based photon detectors
 - Scintillators (in particular plastic scintillators) provide a fast signal, ideal for trigger detectors

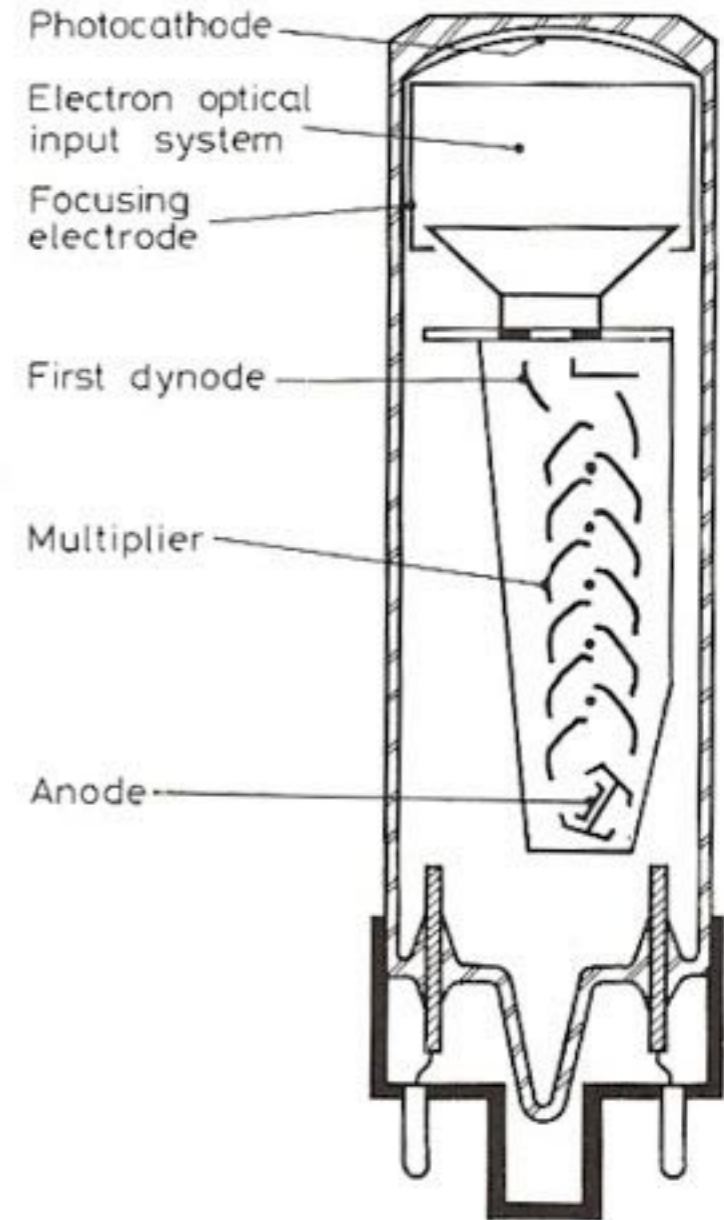

Fig. 8.1. Schematic diagram of a photomultiplier tube (from *Schonkeren* [9.1])

Silicon-Based Photon Detection

- Silicon detectors can also be used to detect visible photons, but:
 - Photo effect only creates a single electron-hole pair (very different from the situation with charged particles): Amplification is crucial!
 - ▶ The usual charge amplification of up to ~ 100 reachable in silicon is insufficient to detect single photons with high efficiency

Silicon-Based Photon Detection

- Silicon detectors can also be used to detect visible photons, but:
 - Photo effect only creates a single electron-hole pair (very different from the situation with charged particles): Amplification is crucial!
 - ▶ The usual charge amplification of up to ~ 100 reachable in silicon is insufficient to detect single photons with high efficiency

Avalanche Photo Diode APD

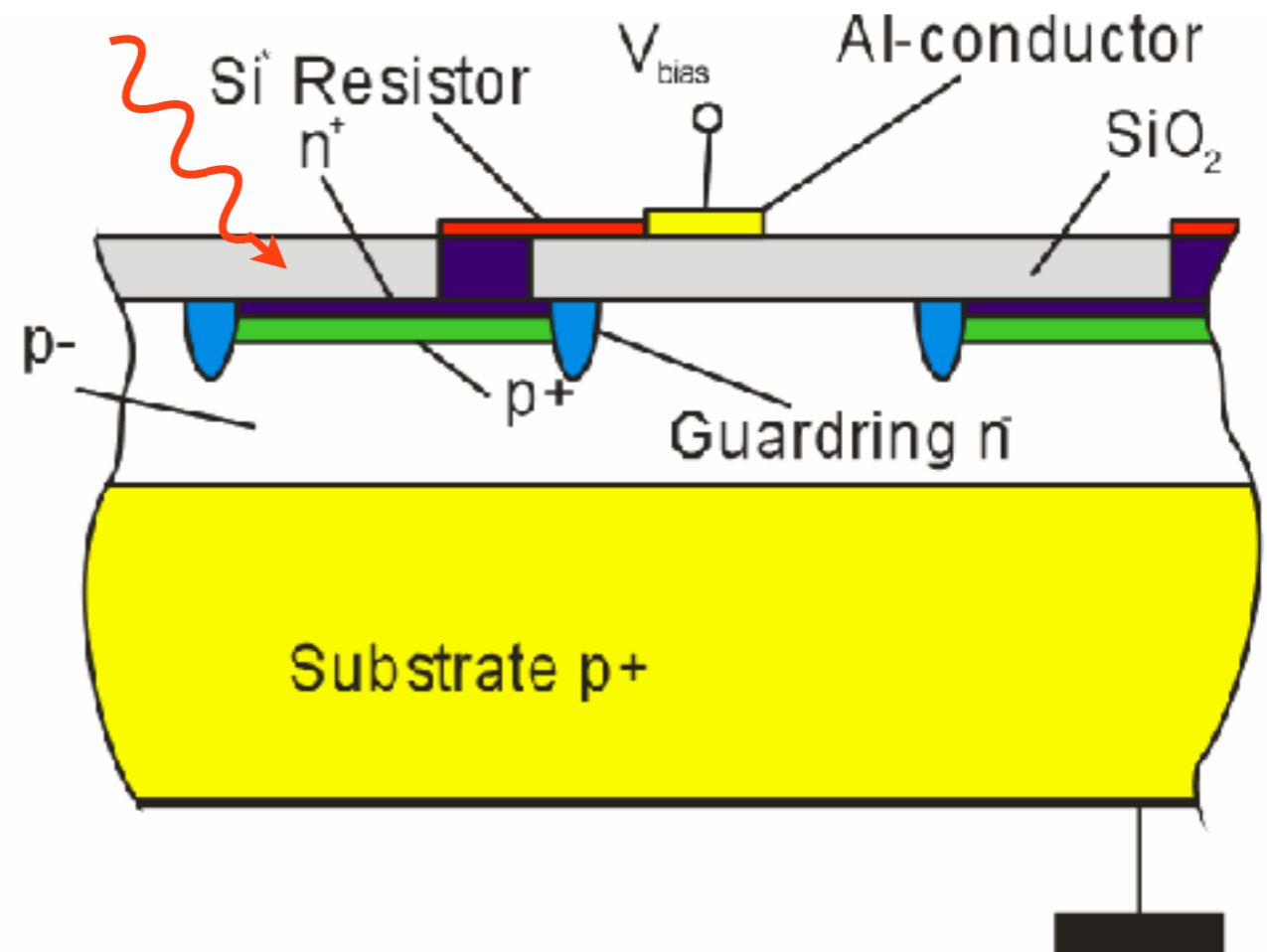
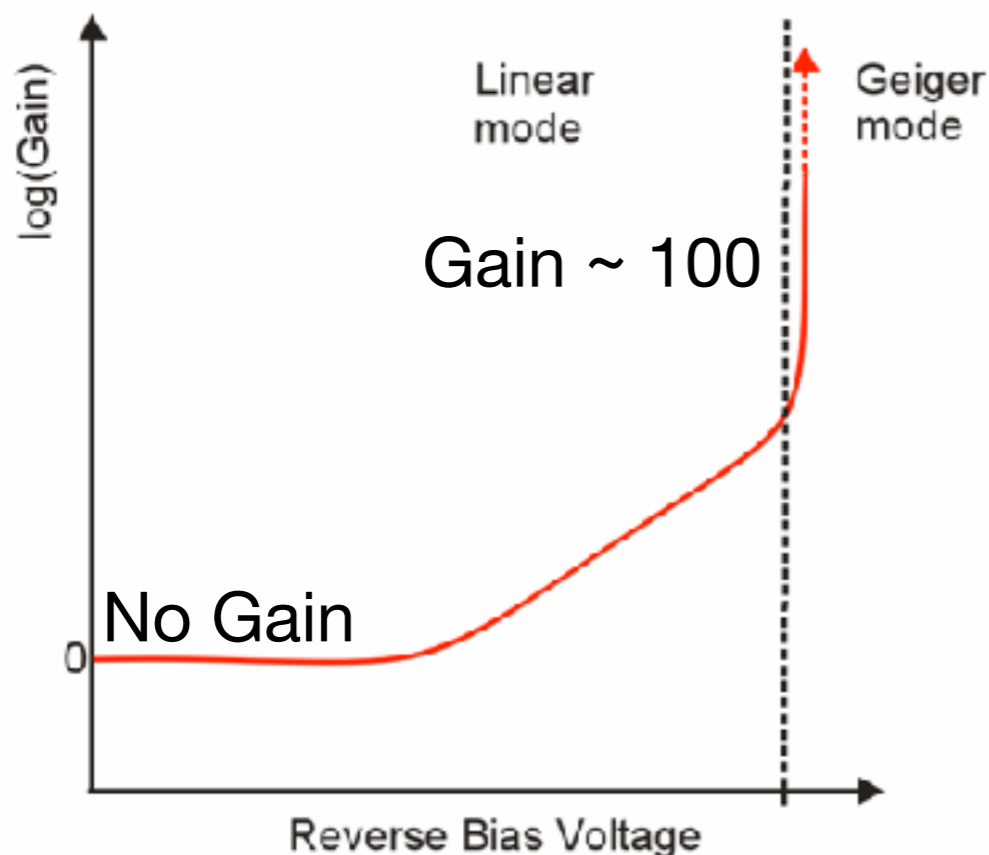

New Photon Sensors: Silicon Photomultipliers

- Highest amplification ($\sim 10^6$) by running APDs in Geiger mode: a single photon triggers a discharge, the diode operates in digital mode: Yes/No, no dependence of the current on the number of photons

New Photon Sensors: Silicon Photomultipliers

- Highest amplification ($\sim 10^6$) by running APDs in Geiger mode: a single photon triggers a discharge, the diode operates in digital mode: Yes/No, no dependence of the current on the number of photons
- The trick: Put many small APDs on a chip, read out the summed-up signal
 - Easy handling: Only one channel (as a PMT, hence the name)
 - Extreme amplification: Detection of single photons not a problem!

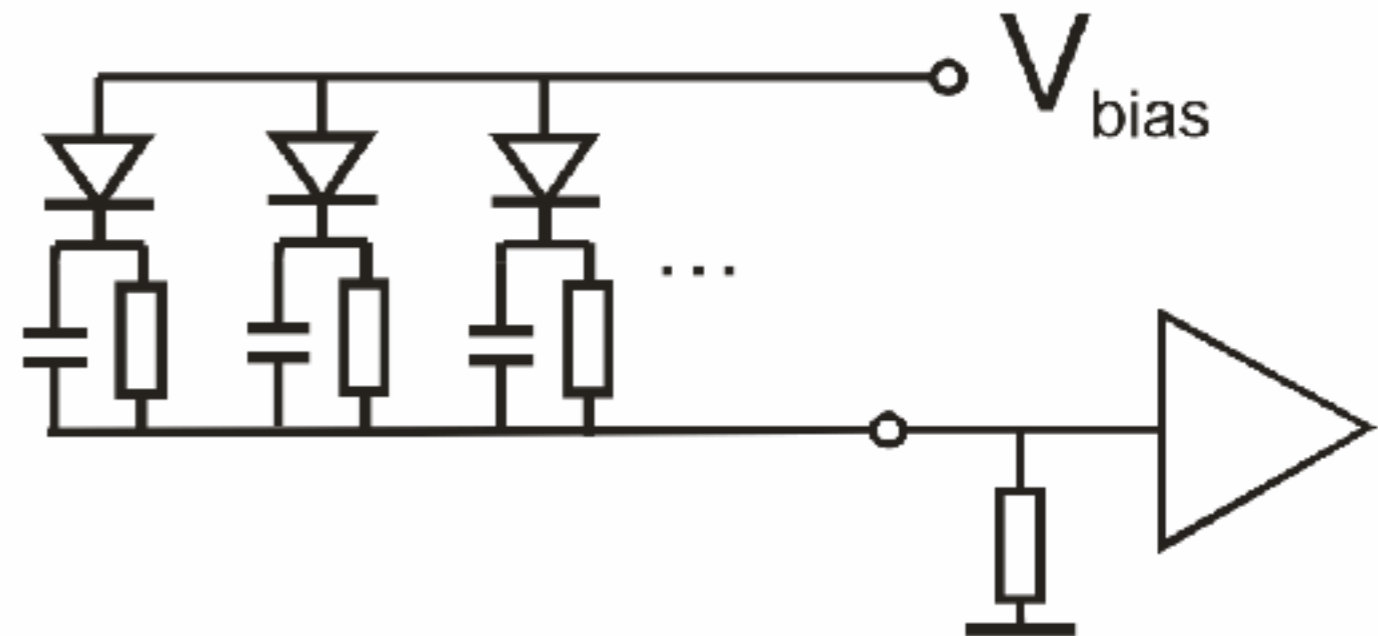
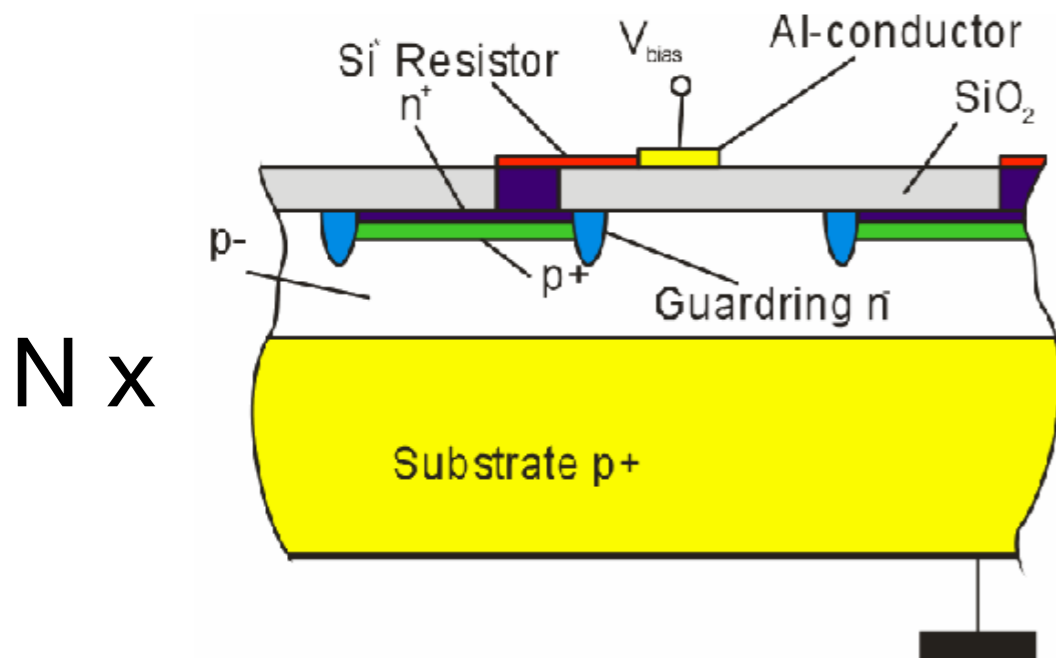

Silicon Photomultiplier (SiPM)

- 10 years ago still “exotic”: CALICE the first HEP instrumentation collaboration to adopt these devices (more next week)
- Today: Well-established manufactures, wide use also outside of HEP

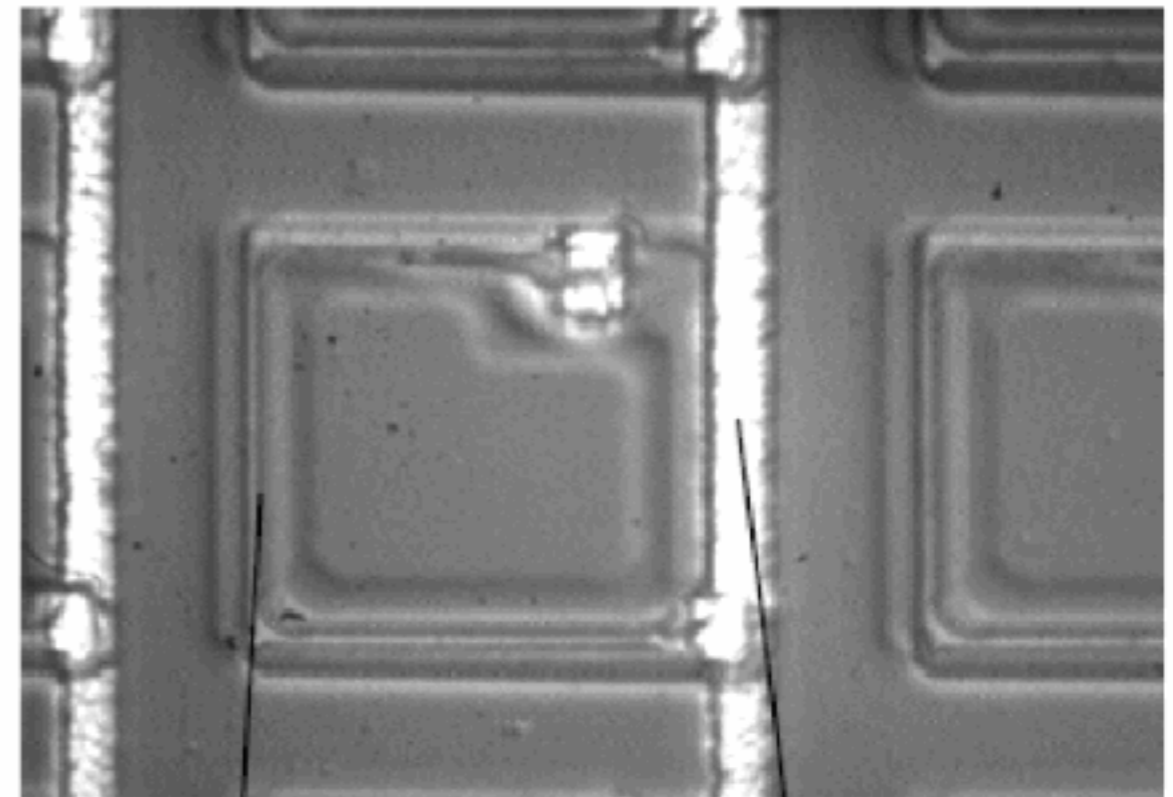
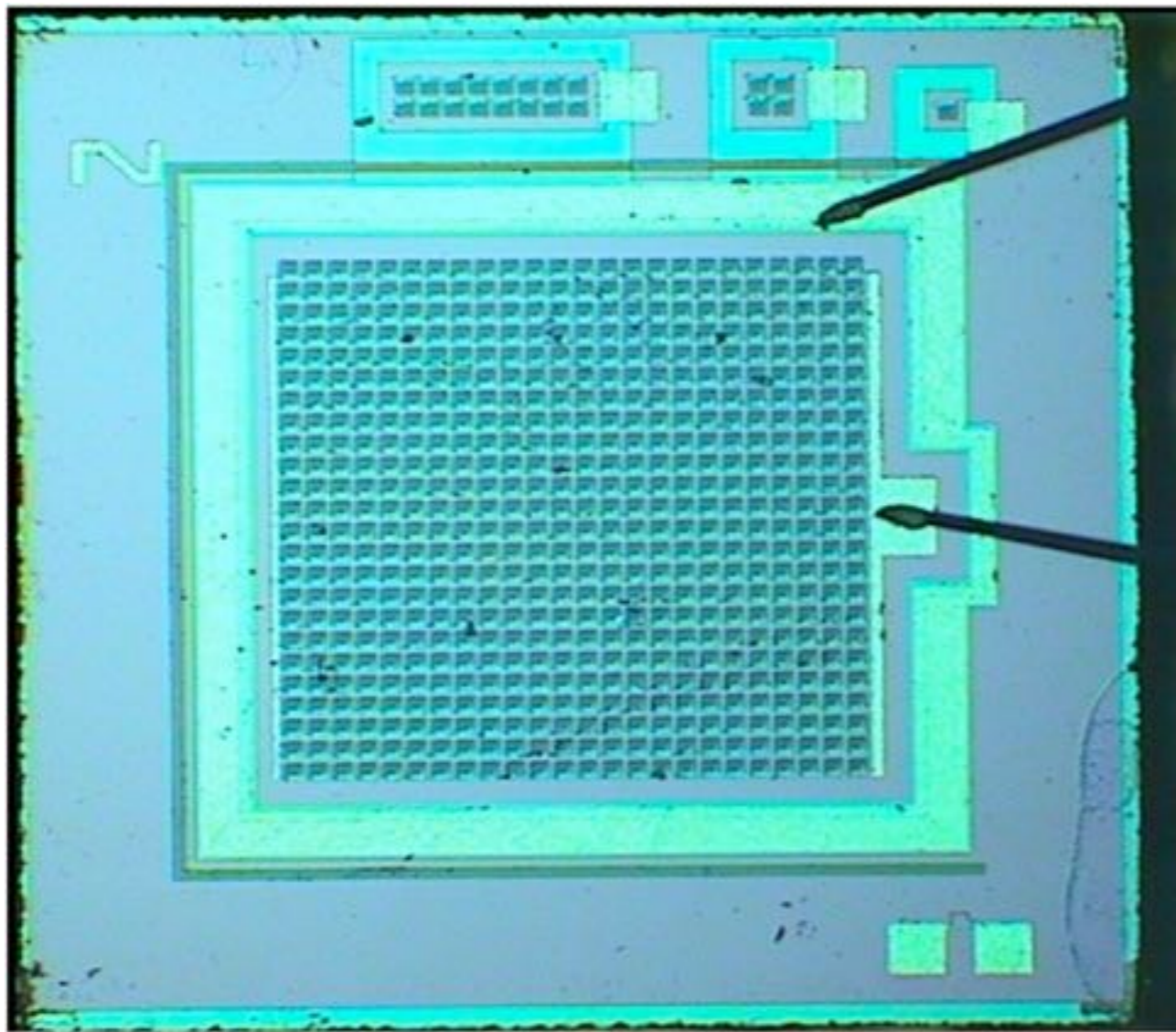

Si^{*} Resistor

Al - conductor

SiPM Signals

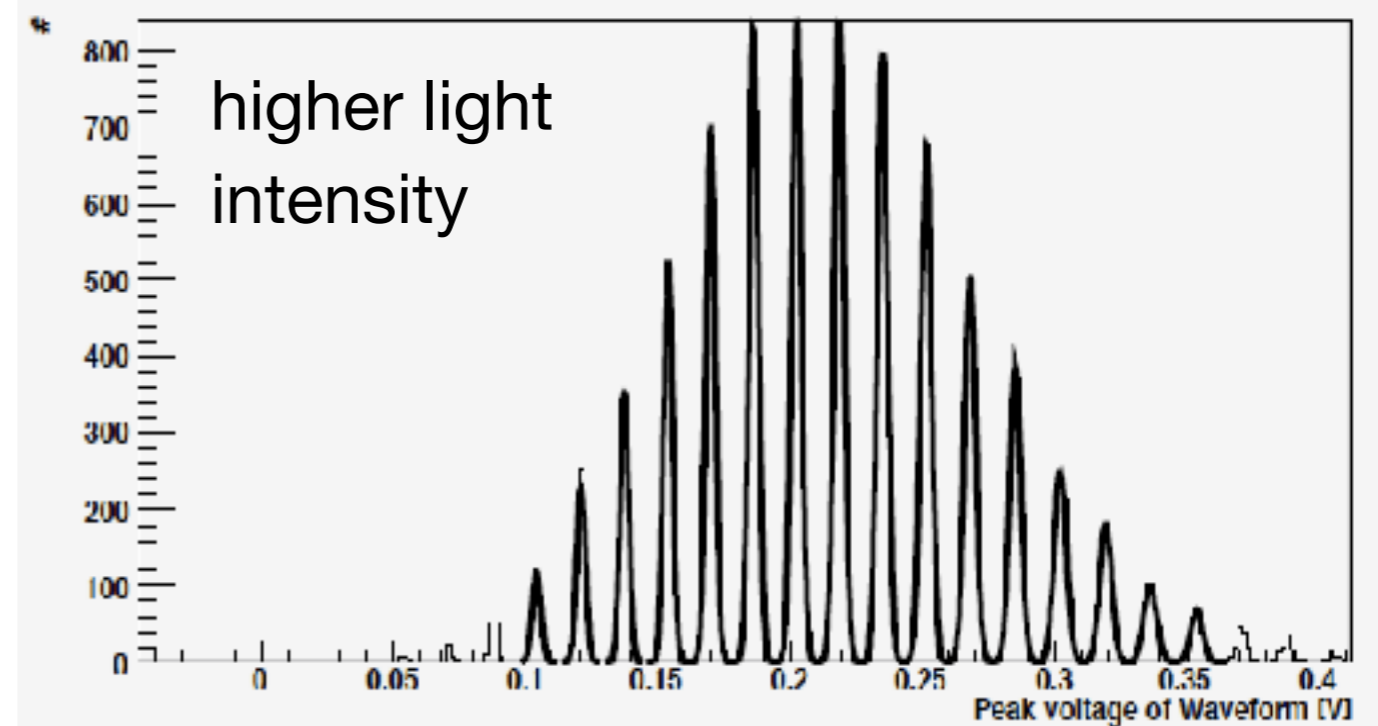
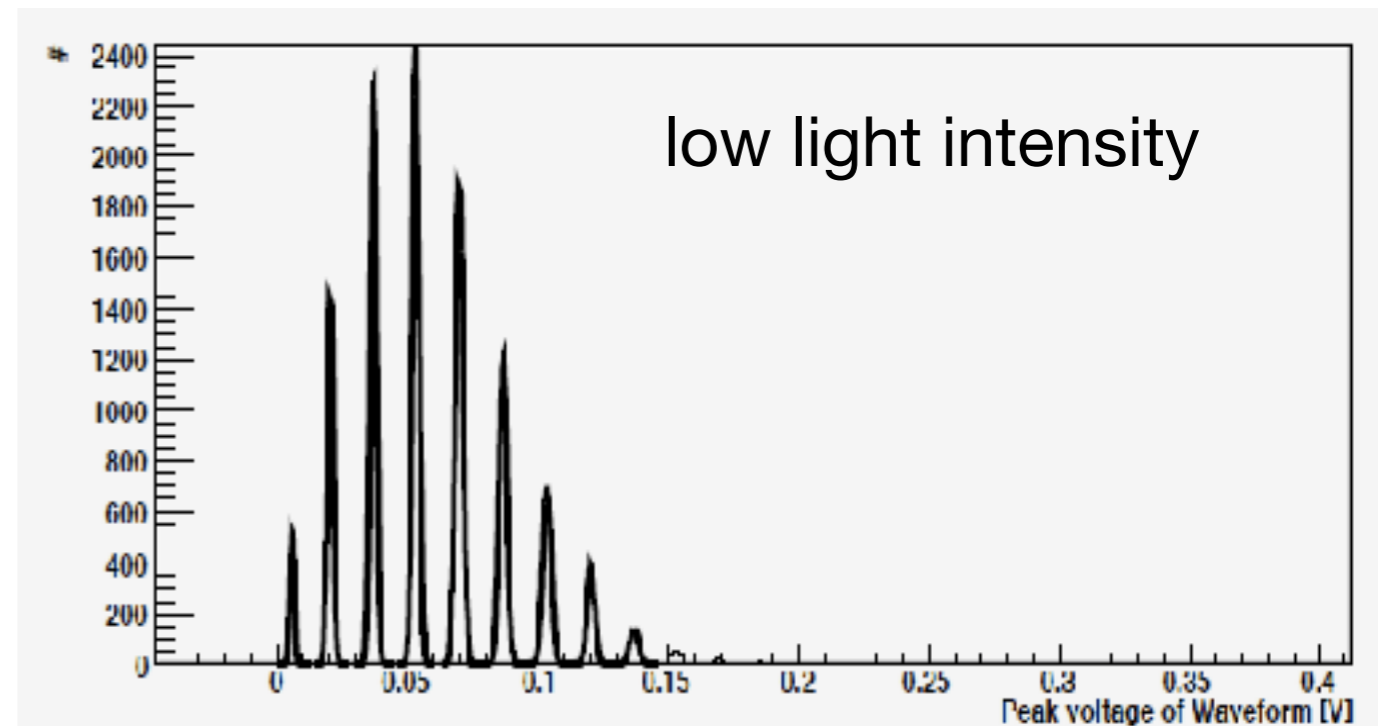
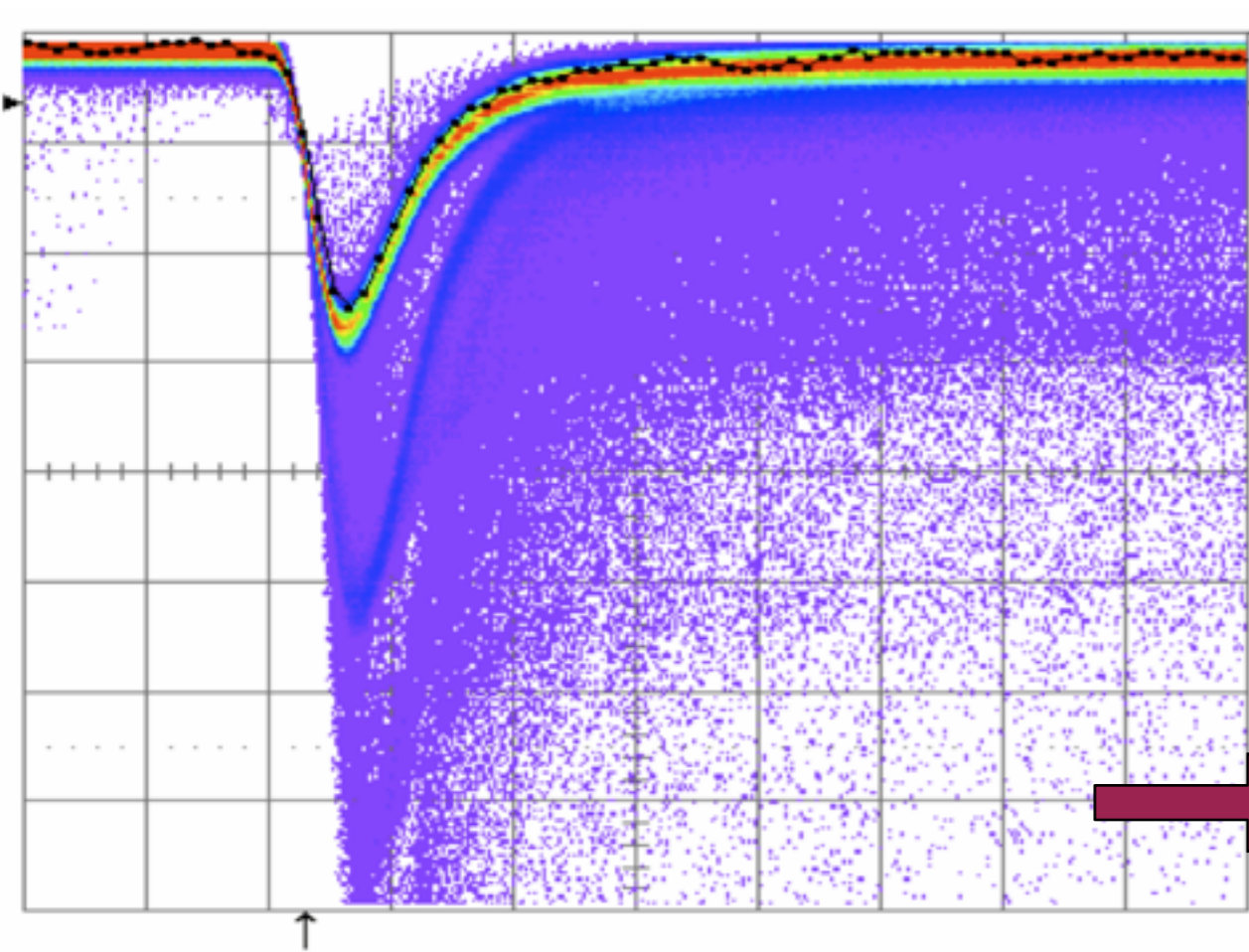

Single photons can be resolved

Other Methods for Particle Detection

- Almost no limit for your creativity
 - Various effects originating from the interaction of particles with matter can be exploited:
- Cherenkov light for the accurate measurement of particle velocity
- Transition radiation for velocity measurement
- ...



Abb. 6.22 Prinzipieller Aufbau eines Übergangsstrahlungsdetektors.



Abb. 6.23 Prinzipieller Verlauf der Häufigkeitsverteilung des Energieverlustes hochenergetischer Elektronen für einen Übergangsstrahlungsdetektor mit Radiator und "Ersatzradiator" (nach [143]).

Summary

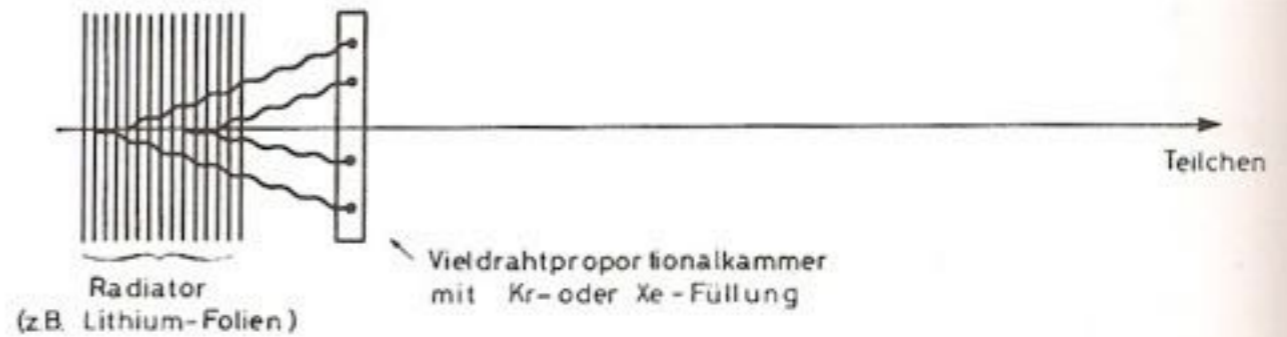
- Detector systems at colliders detect stable and long-lived particles
Observables are energy, momentum, time of flight; tracks and secondary vertices and particle identification
- A central component of all detectors is the magnetic field - Solenoids are standard, but other solutions are used as well
- The most commonly used mechanism is ionization by charged particles
 - Described by the Bethe-Bloch Equation
- Many different techniques are used for particle detection
 - Gas-filled ionization chambers, multi-wire chambers and drift chambers
 - Semiconductor detectors
 - Scintillators with suitable photon detectors
 - Transition radiation detectors, Cherenkov detectors, ...

Summary

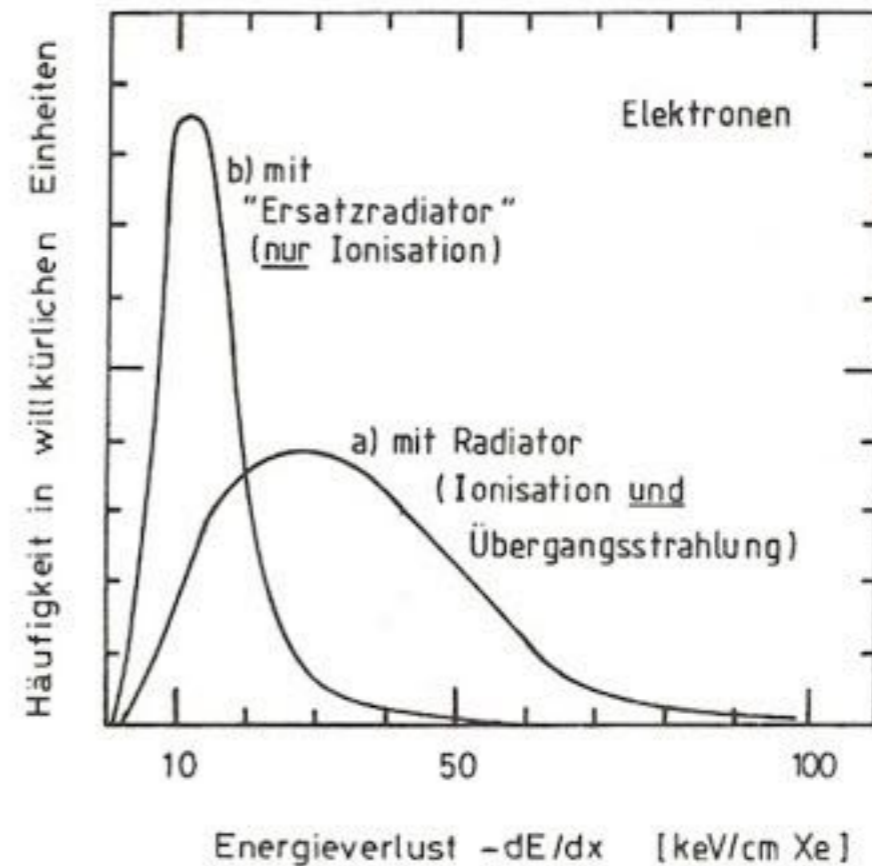
- Detector systems at colliders detect stable and long-lived particles
Observables are energy, momentum, time of flight; tracks and secondary vertices and particle identification
- A central component of all detectors is the magnetic field - Solenoids are standard, but other solutions are used as well
- The most commonly used mechanism is ionization by charged particles
 - Described by the Bethe-Bloch Equation
- Many different techniques are used for particle detection
 - Gas-filled ionization chambers, multi-wire chambers and drift chambers
 - Semiconductor detectors
 - Scintillators with suitable photon detectors
 - Transition radiation detectors, Cherenkov detectors, ...

Next Lecture: Detectors II, F. Simon, 14.11.2016



Schedule

1.	Introduction	17.10.
2.	Accelerators	24.10.
	----- no lecture -----	31.10.
3.	Particle Detectors I	07.11.
4.	Particle Detectors II	14.11.
5.	Trigger, Data Acquisition, Computing	21.11.
6.	Monte Carlo Generators and Detector Simulation	28.11.
7.	QCD, Jets, Proton Structure	05.12.
8.	Tests of the Standard Model	12.12.
9.	Top Physics	07.12.
	----- Christmas -----	
10.	Higgs Physics I	09.01.
11.	Higgs Physics II	16.01.
12.	Physics beyond the SM	23.01.
13.	LHC Outlook & Future Collider Projects	30.01.
	----- no lecture -----	06.02.

