

Teilchenphysik mit kosmischen und mit erdgebundenen Beschleunigern

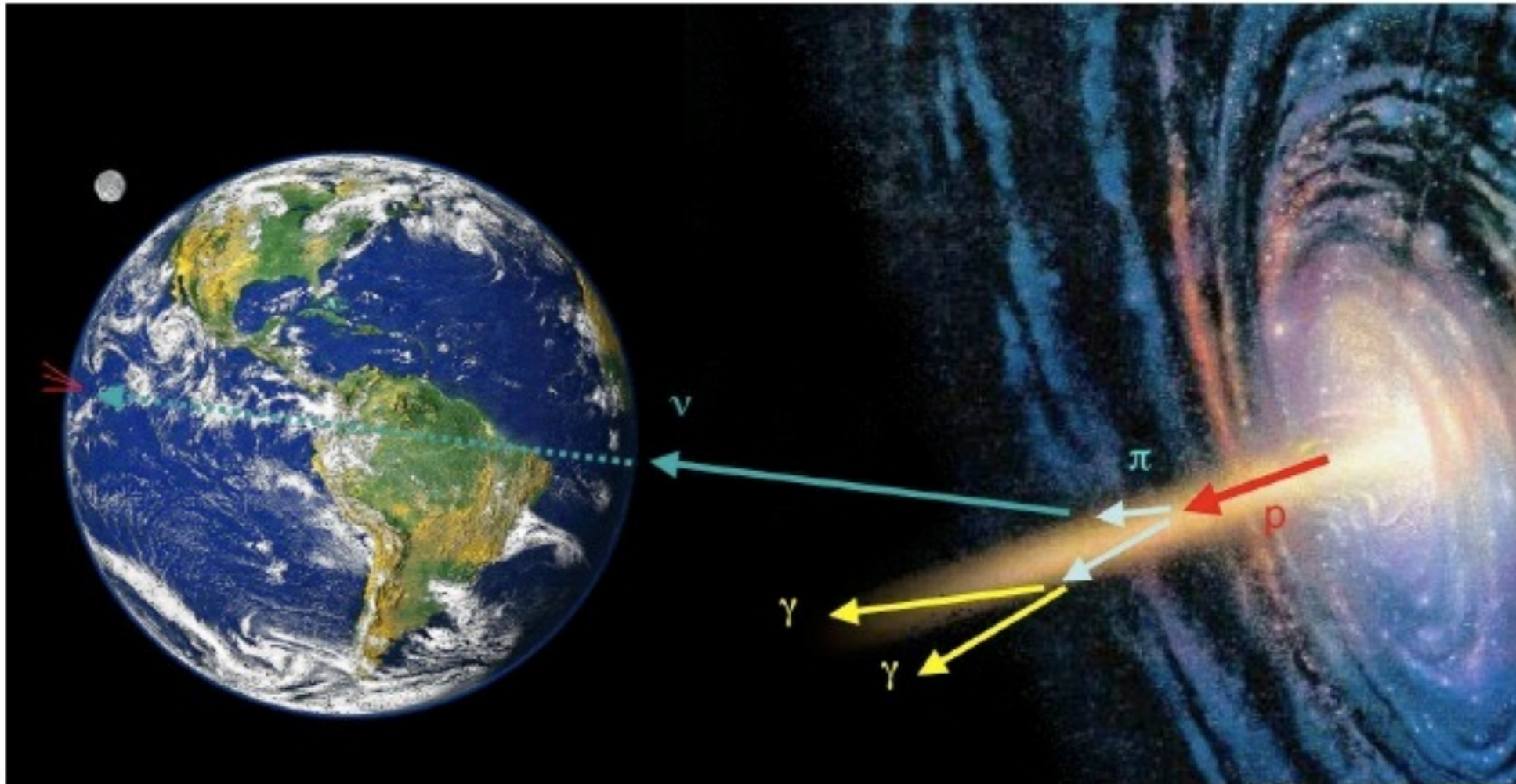

03. Detectors in Particle & Astroparticle Physics

15.05.2017



Overview

- Detectors in Particle and Astroparticle Physics
 - Large Detector Systems at LHC
 - Large Detectors in Astroparticle Physics
- Basics: Interaction of Particles with Matter
- Detection Techniques
- A Few Examples

Overview:

Detectors in Particle and Astroparticle Physics

Challenges at Hadron-Colliders

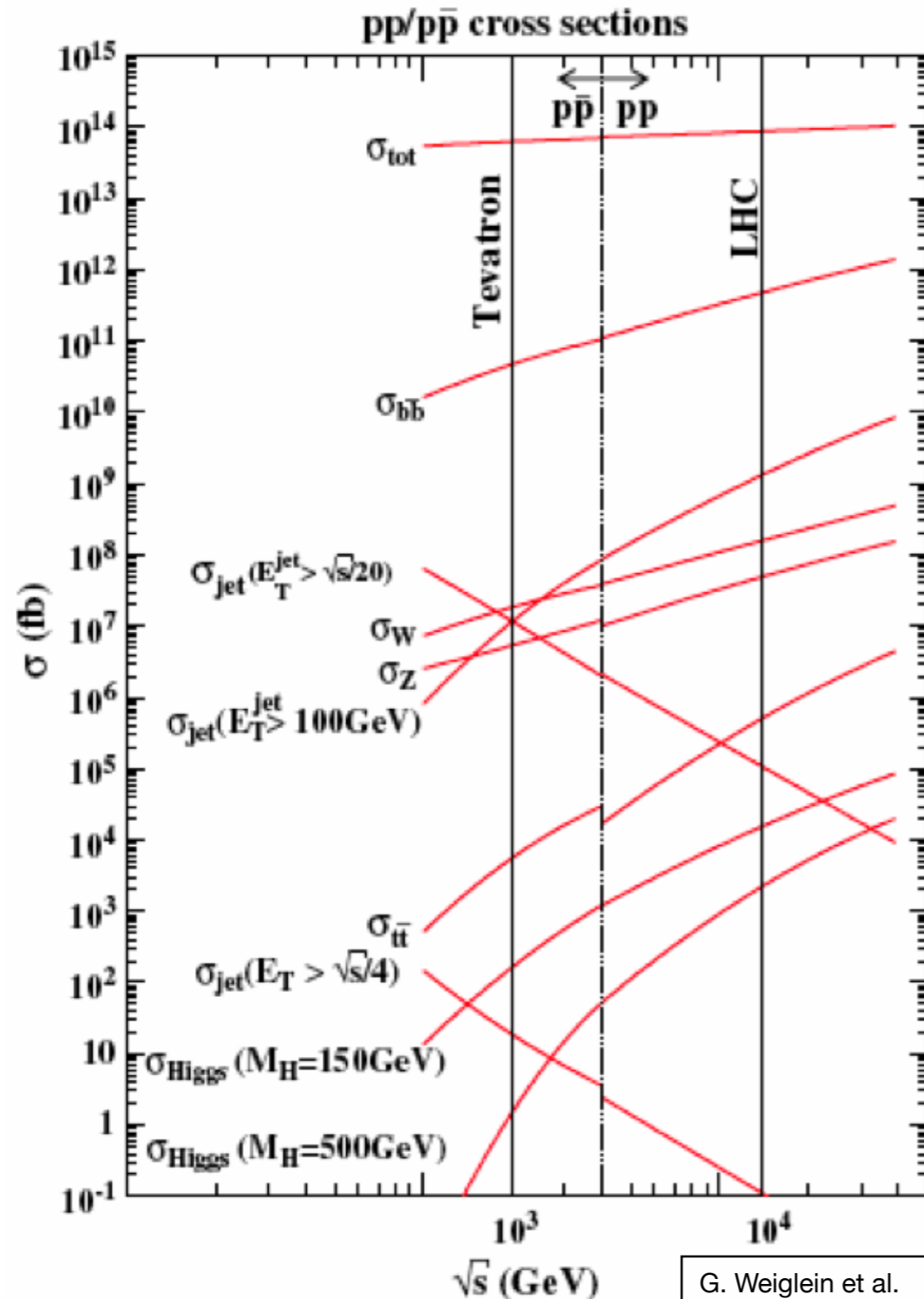

G. Weiglein et al.
Physics Reports 426 (2006) 47–358

- At Hadron-Colliders:
 - Extreme event rates:
Interesting processes are much rarer than “normal” processes
 - ▶ Detectors are optimized to cope with very high event rates and high particle density, and for picking up rare signatures out of large backgrounds

Detectors in Particle Physics

- Detection of the products of particle collisions in the detector system
 - Signals are obtained via electromagnetic interactions with the detector material

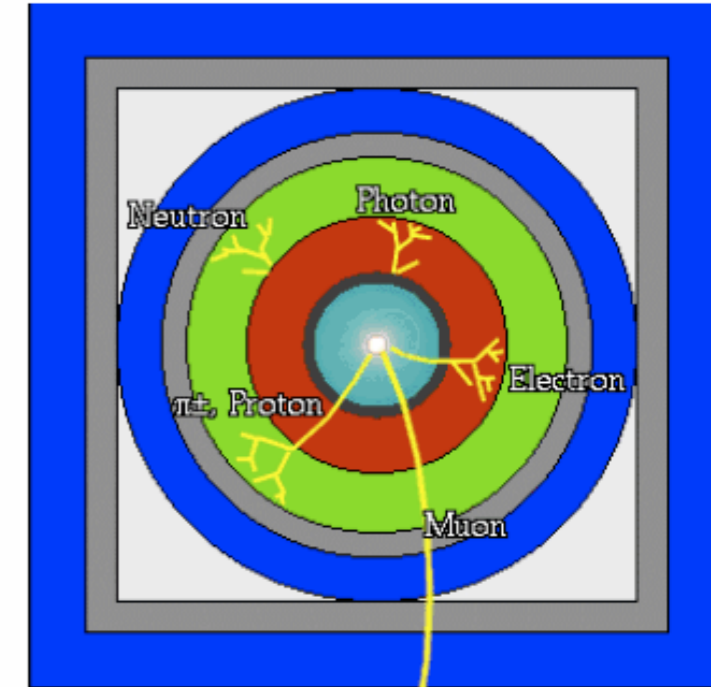
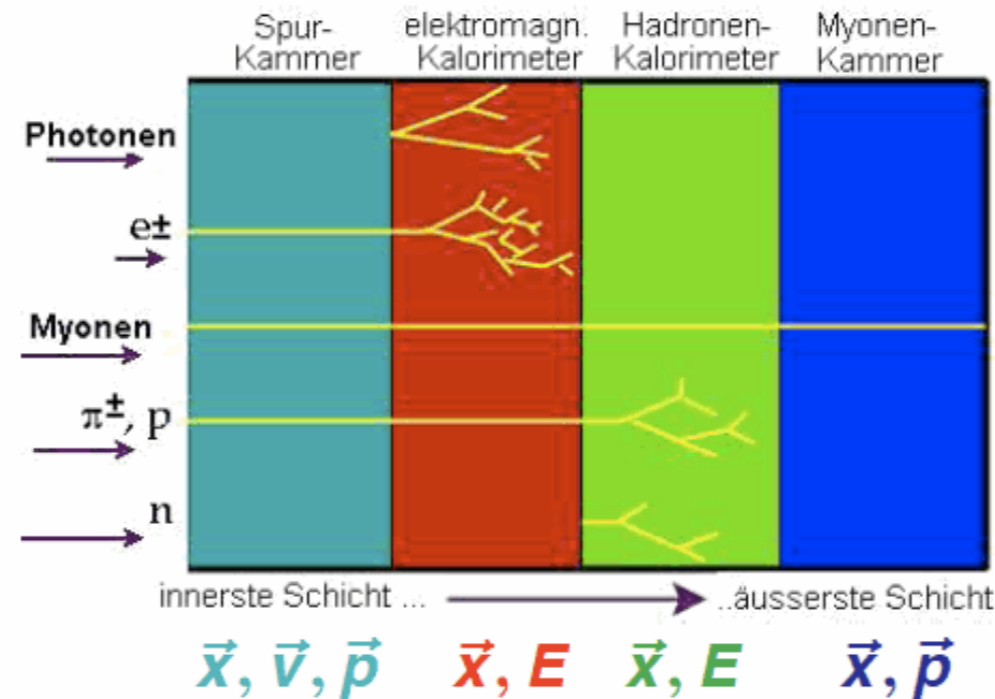
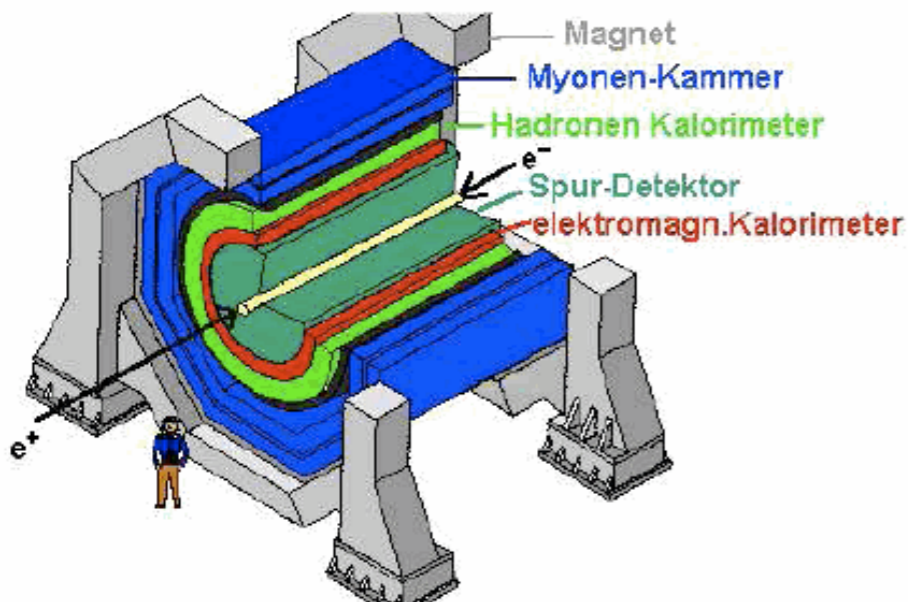

Detectors in Particle Physics

- Detection of the products of particle collisions in the detector system
 - Signals are obtained via electromagnetic interactions with the detector material

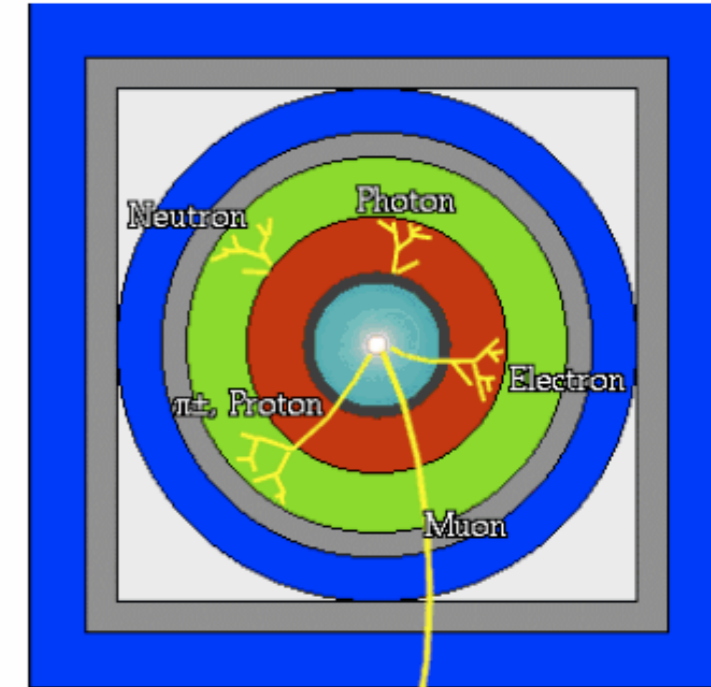
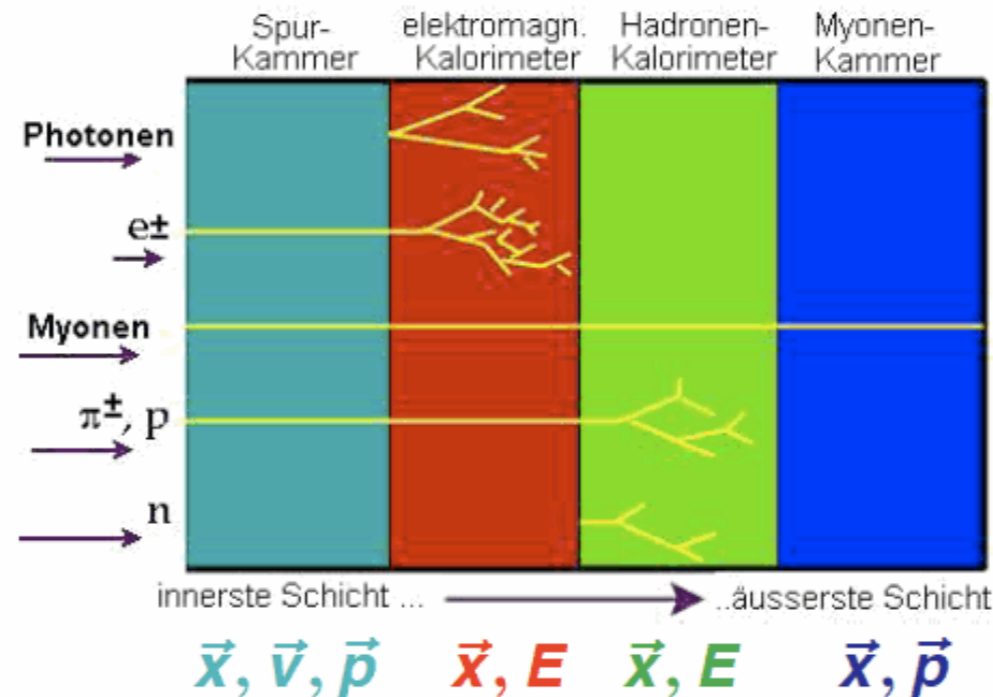
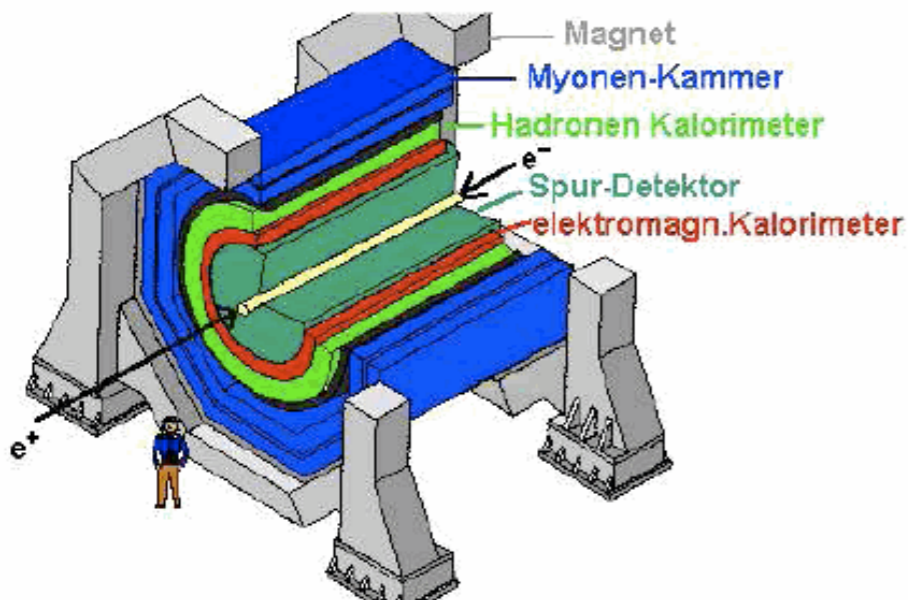

Tracker: Momentum of charged particles via deflection in magnetic field and precise track reconstruction

Detectors in Particle Physics

- Detection of the products of particle collisions in the detector system
 - Signals are obtained via electromagnetic interactions with the detector material

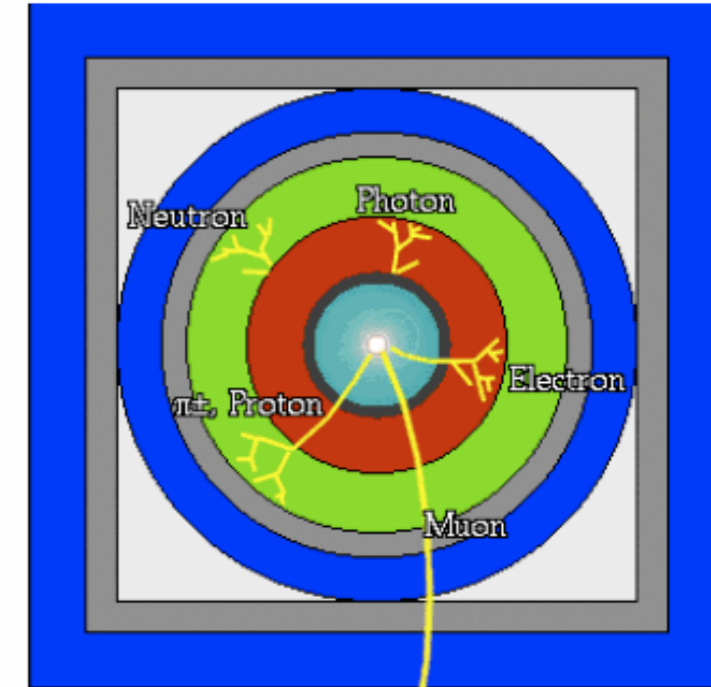
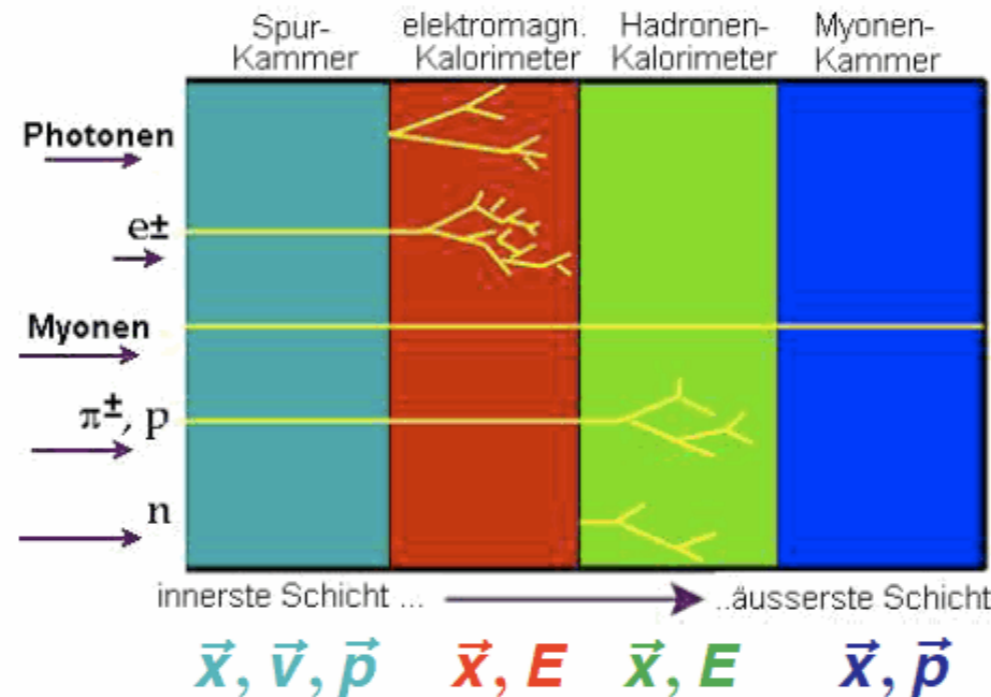
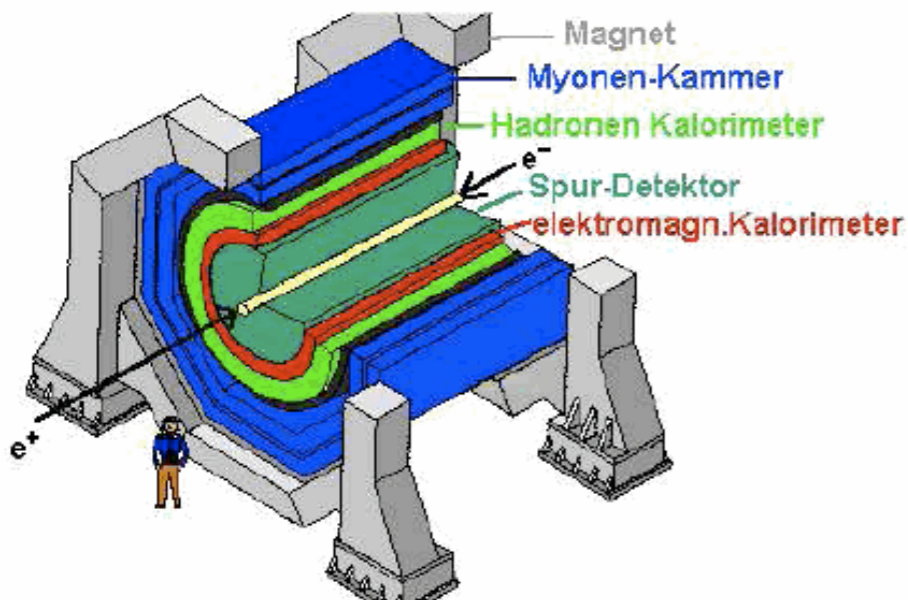

Tracker: Momentum of charged particles via deflection in magnetic field and precise track reconstruction

Calorimeter: Energy measurement of photons, electrons and hadrons via total absorption

Detectors in Particle Physics

- Detection of the products of particle collisions in the detector system
 - Signals are obtained via electromagnetic interactions with the detector material

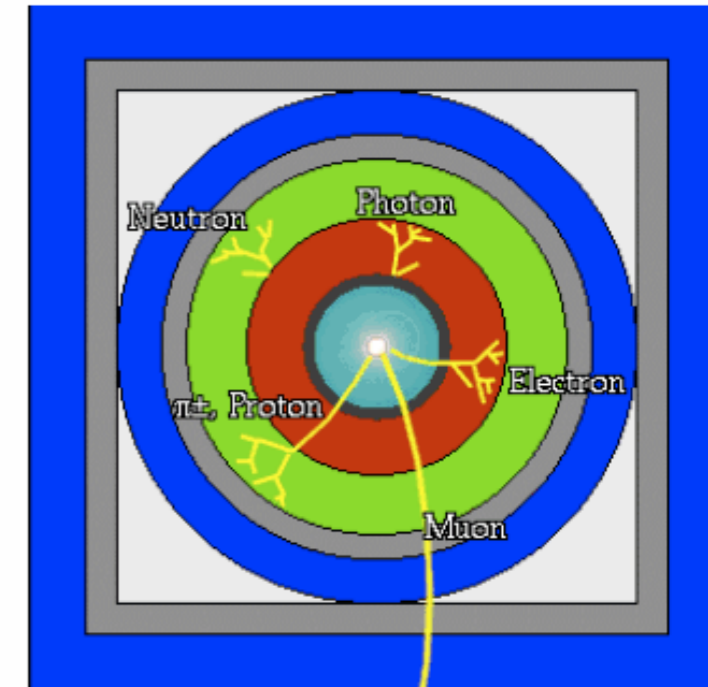
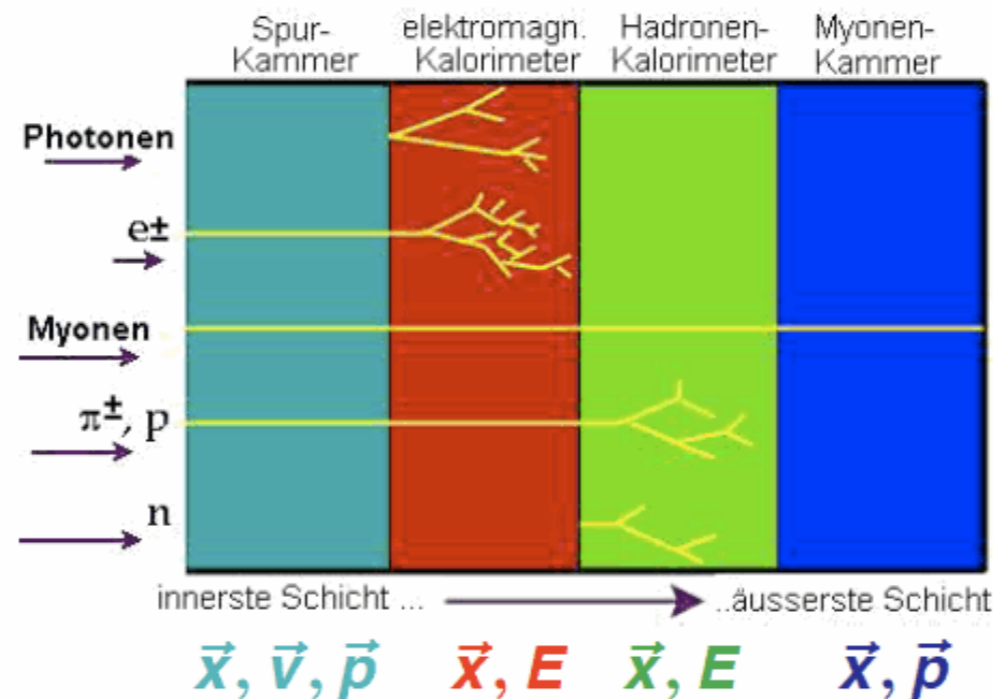
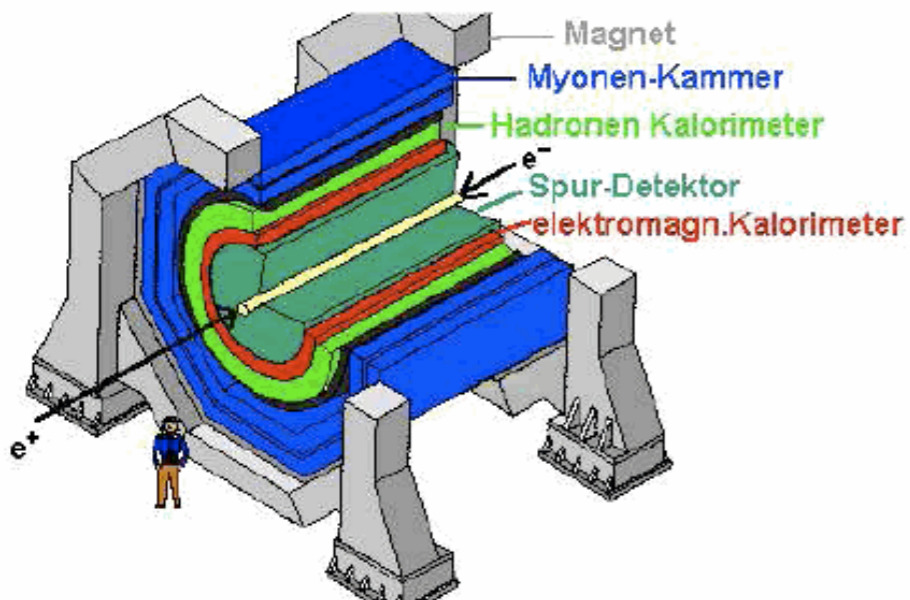

Tracker: Momentum of charged particles via deflection in magnetic field and precise track reconstruction

Calorimeter: Energy measurement of photons, electrons and hadrons via total absorption

Muon Detectors: Identification and momentum measurement of muons

Collider-Detectors: Cross Section [CMS]

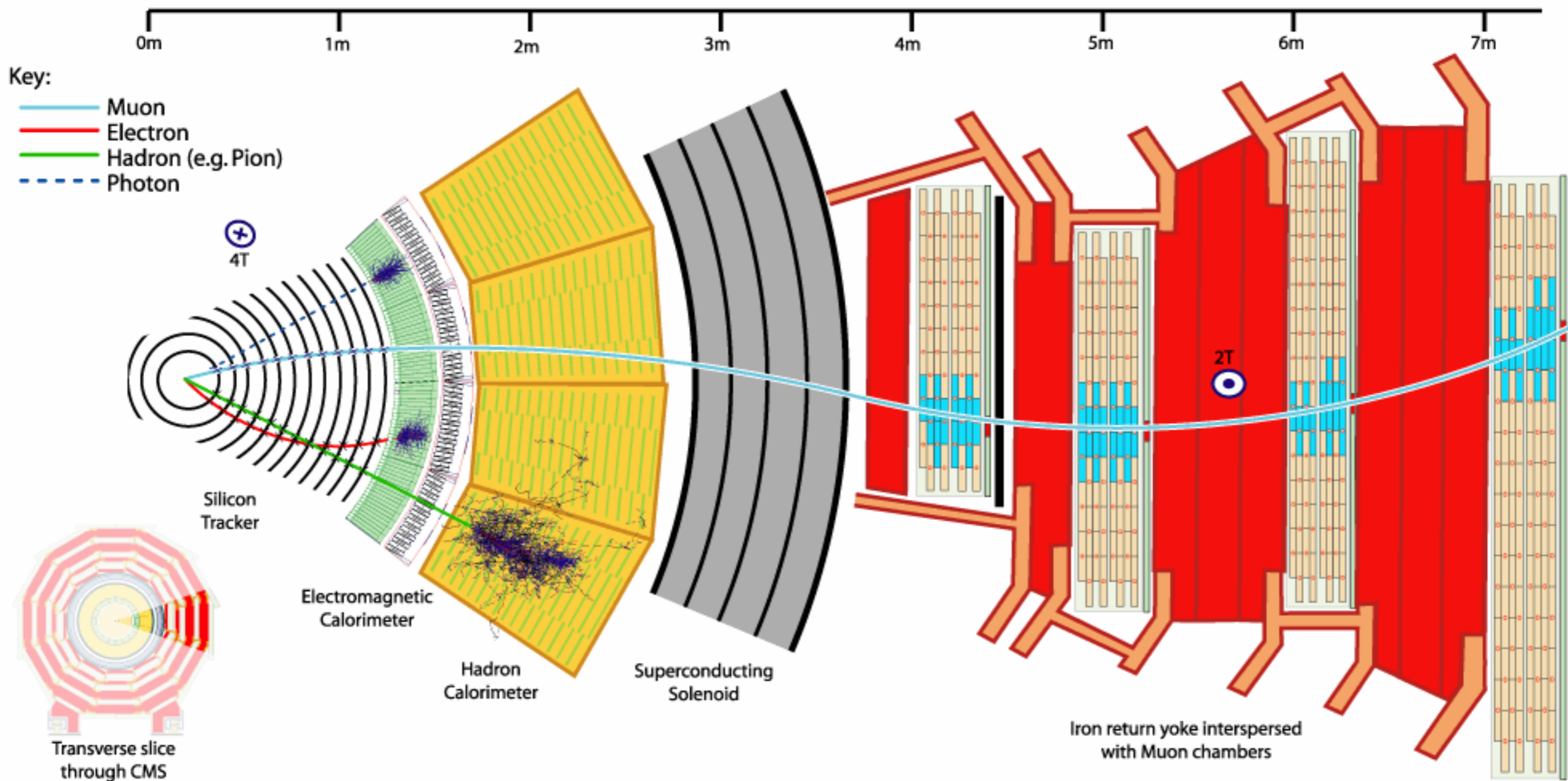

- High energies require high magnetic fields and large detectors
- Shown here: CMS, (C is for Compact!)

Challenges in Astroparticle Physics

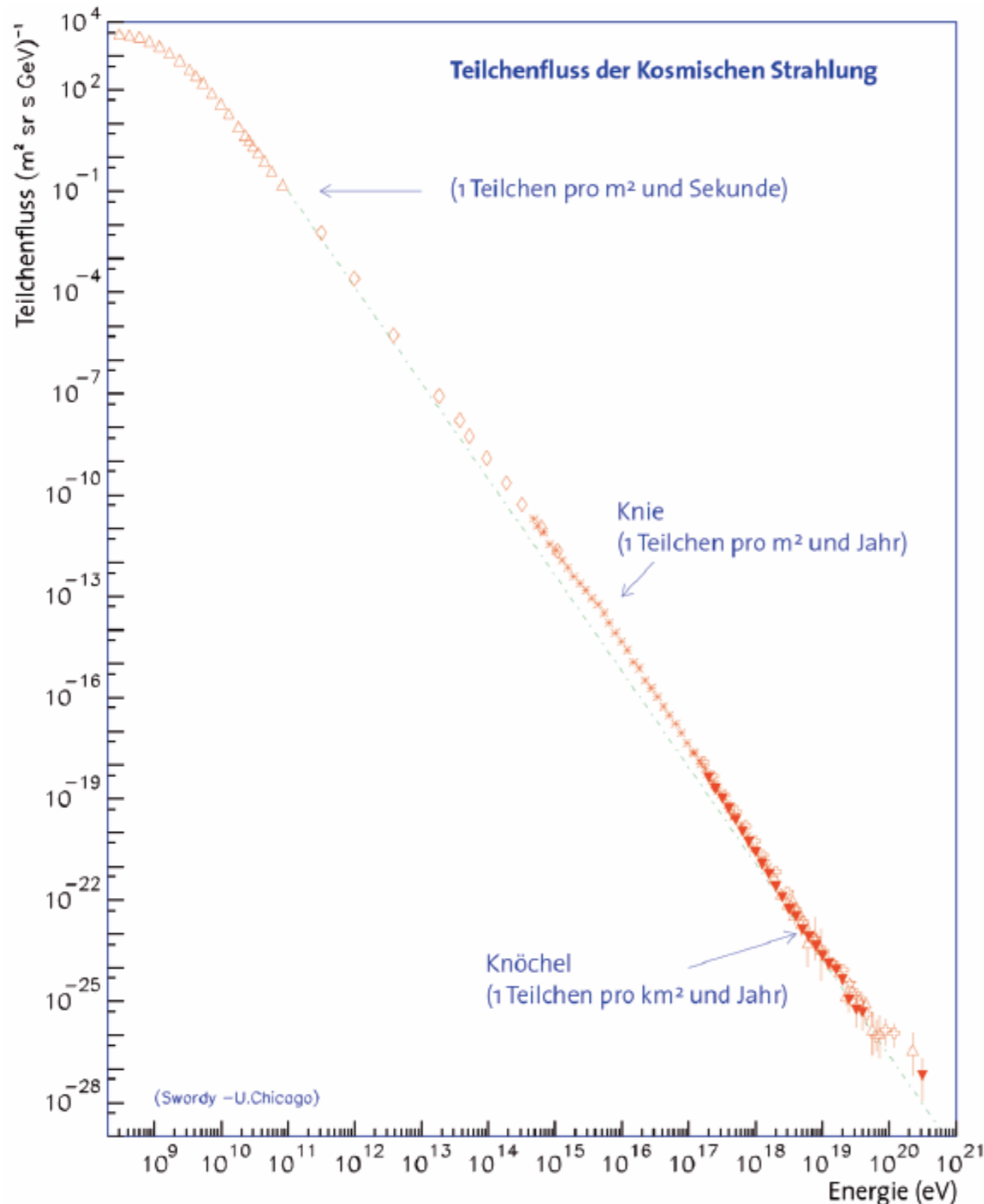

- Search for very rare events
 - ▶ Large areas / volumes have to be covered
 - ▶ Good suppression of background
 - ▶ High efficiency: Can not afford to loose events
 - ▶ Data rates, radiation damage, ... usually not an issue

What do we want to measure?

- Highly energetic particles from cosmic sources: hadrons, photons
 - Either: Measurement outside of the atmosphere
 - Or: Use of the atmosphere as detector, particle detectors via air showers
- Neutrinos
 - Low cross section => Large detector volumes
- Dark Matter
 - Low cross sections => large sensitive volumes / masses, extreme suppression of background

MAGIC: High-Energy Gammas

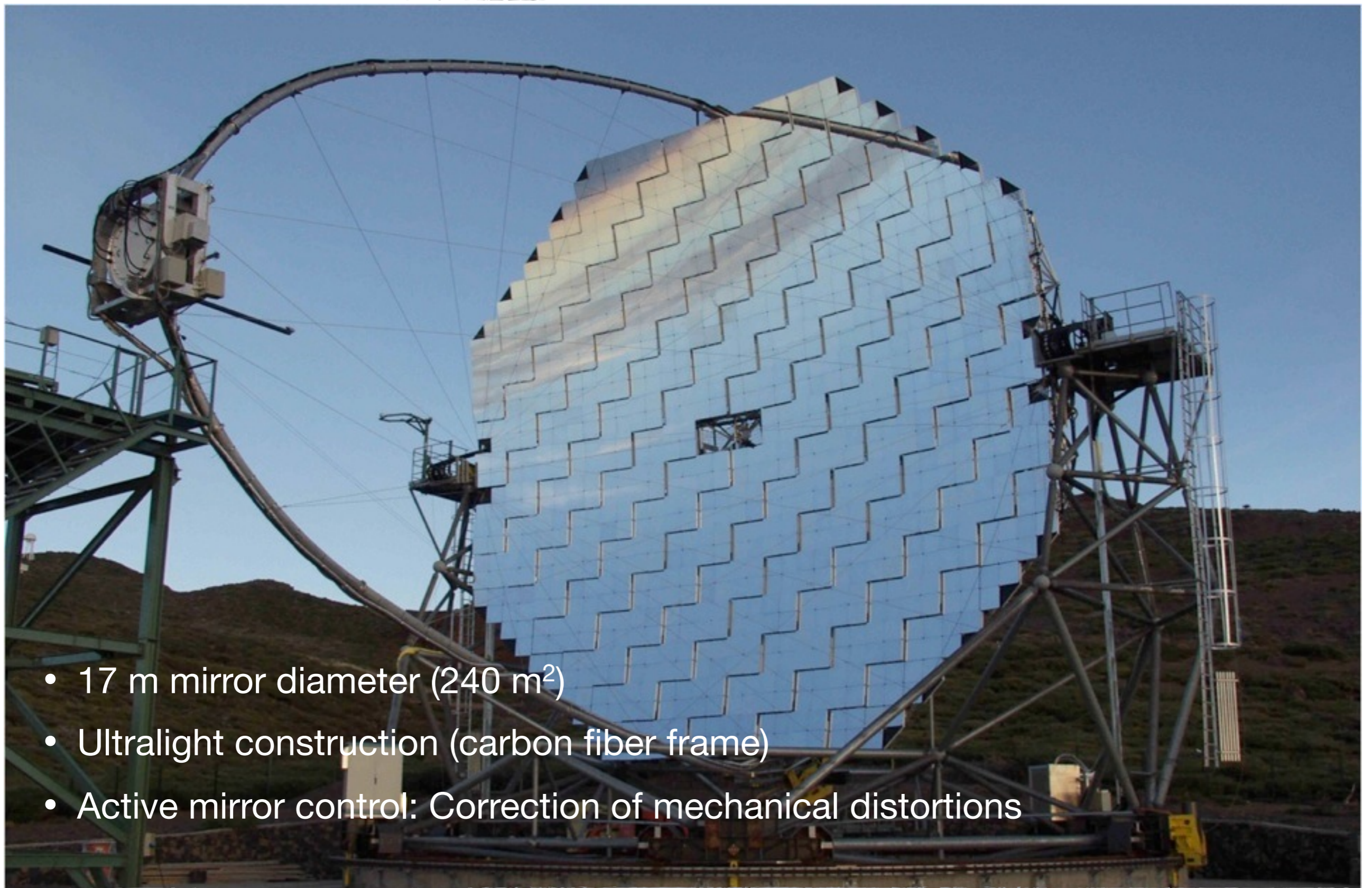

- 17 m mirror diameter (240 m²)
- Ultralight construction (carbon fiber frame)
- Active mirror control: Correction of mechanical distortions

AUGER: Highly Energetic Charged Particles

- 1600 Water-Cherenkov-detectors on the ground
- 4 fluorescence stations with 6 telescopes each
- 3000 km²

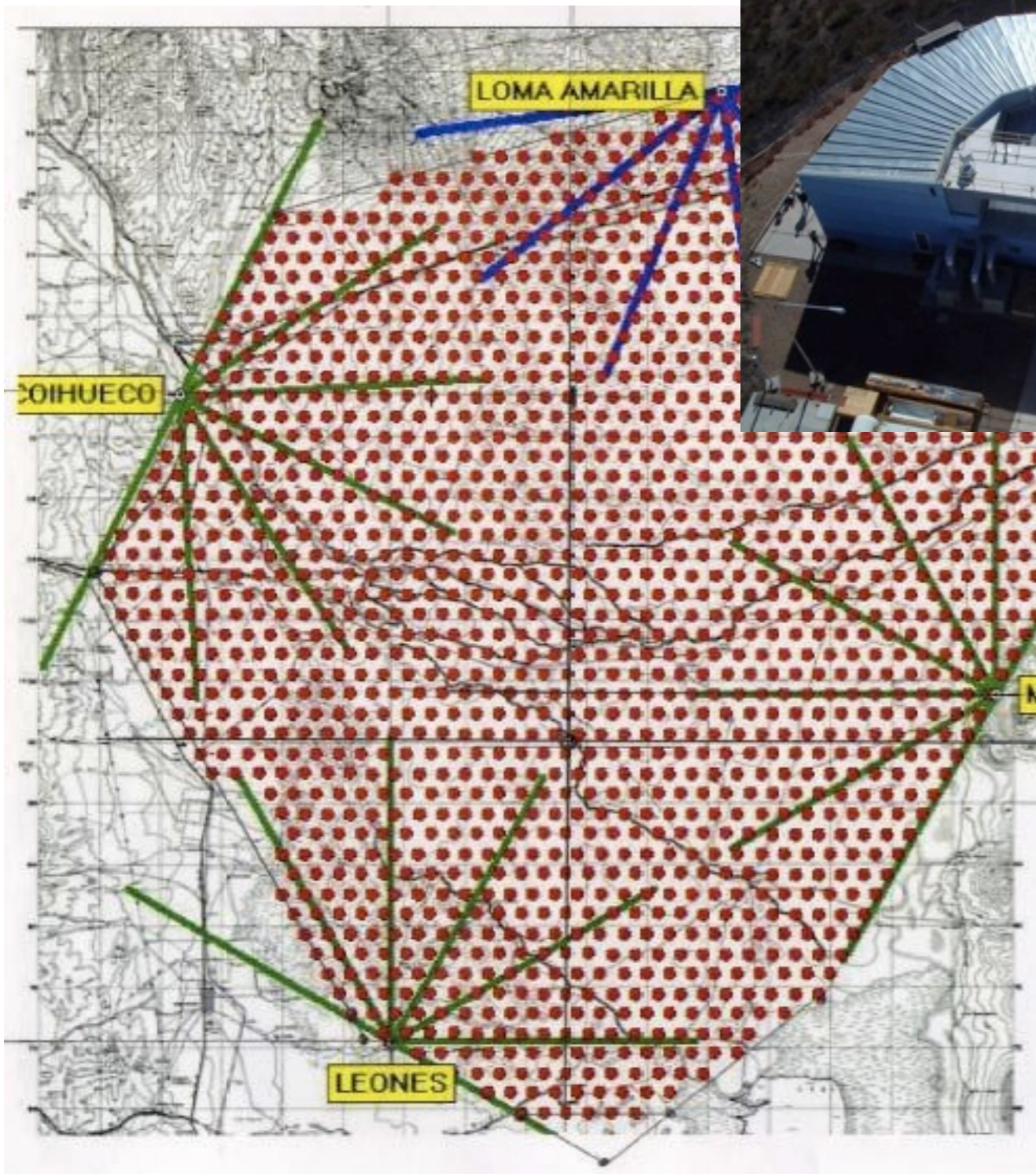

Amanda/IceCube

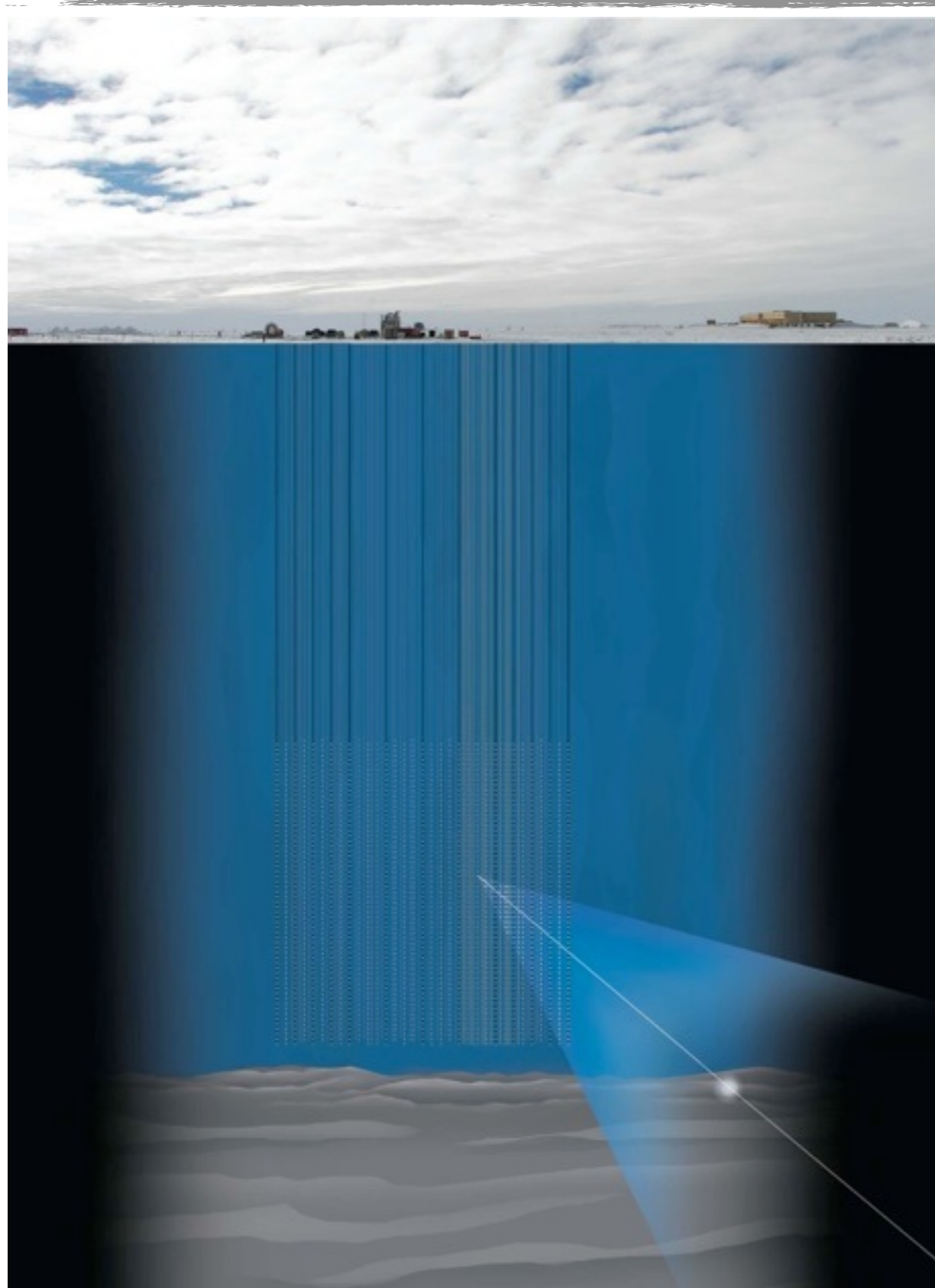

IceCube: 1 km³ instrumented volume

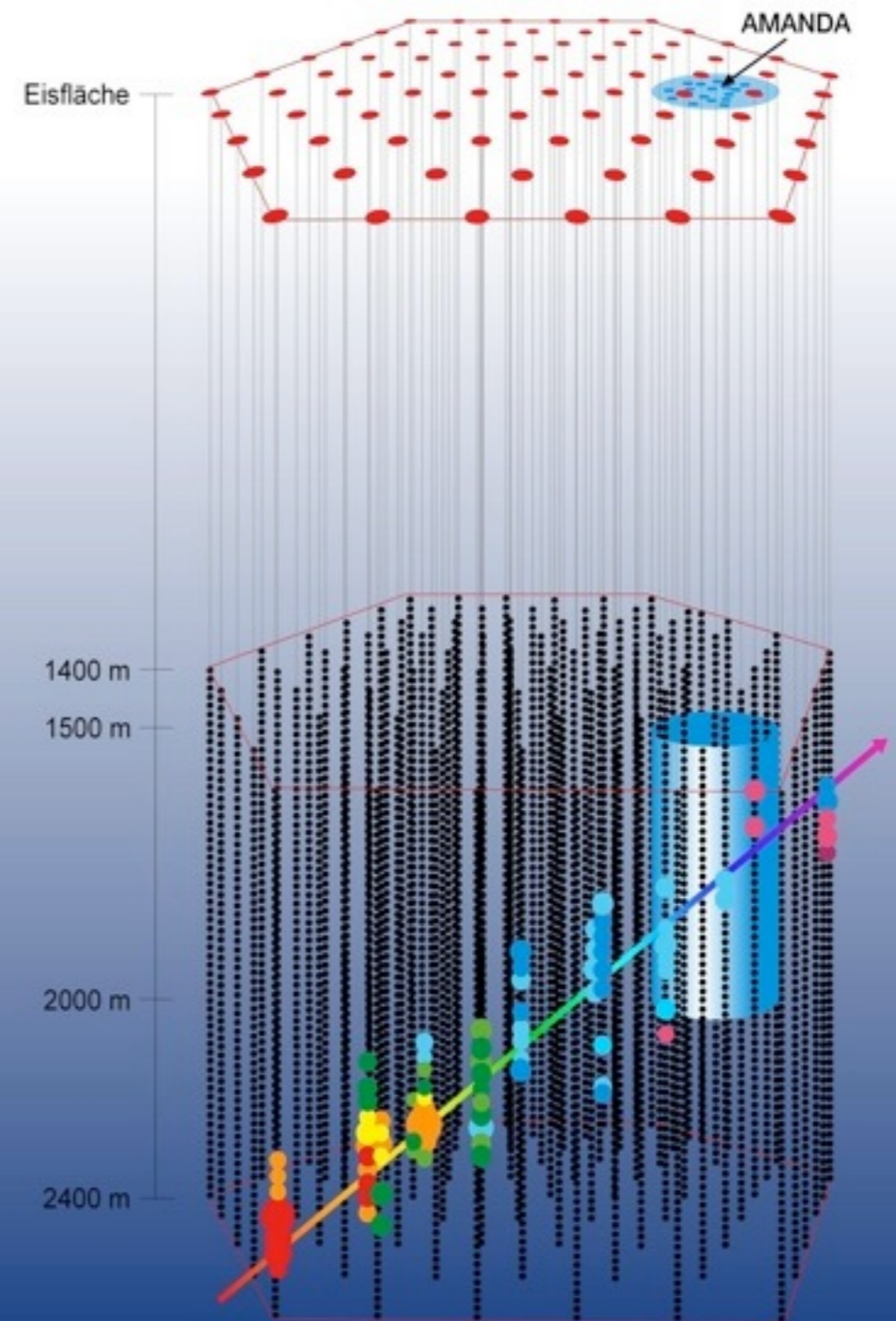

The Basics of Particle Detection: Interaction of Particles with Matter

Energy Loss in Matter: Bethe-Bloch

- The Bethe-Bloch equation describes energy loss through ionization

$$-\frac{dE}{dx} = K z^2 \frac{Z}{A} \frac{1}{\beta^2} \left[\frac{1}{2} \ln \frac{2m_e c^2 \beta^2 \gamma^2 T_{\max}}{I^2} - \beta^2 - \frac{\delta}{2} \right]$$

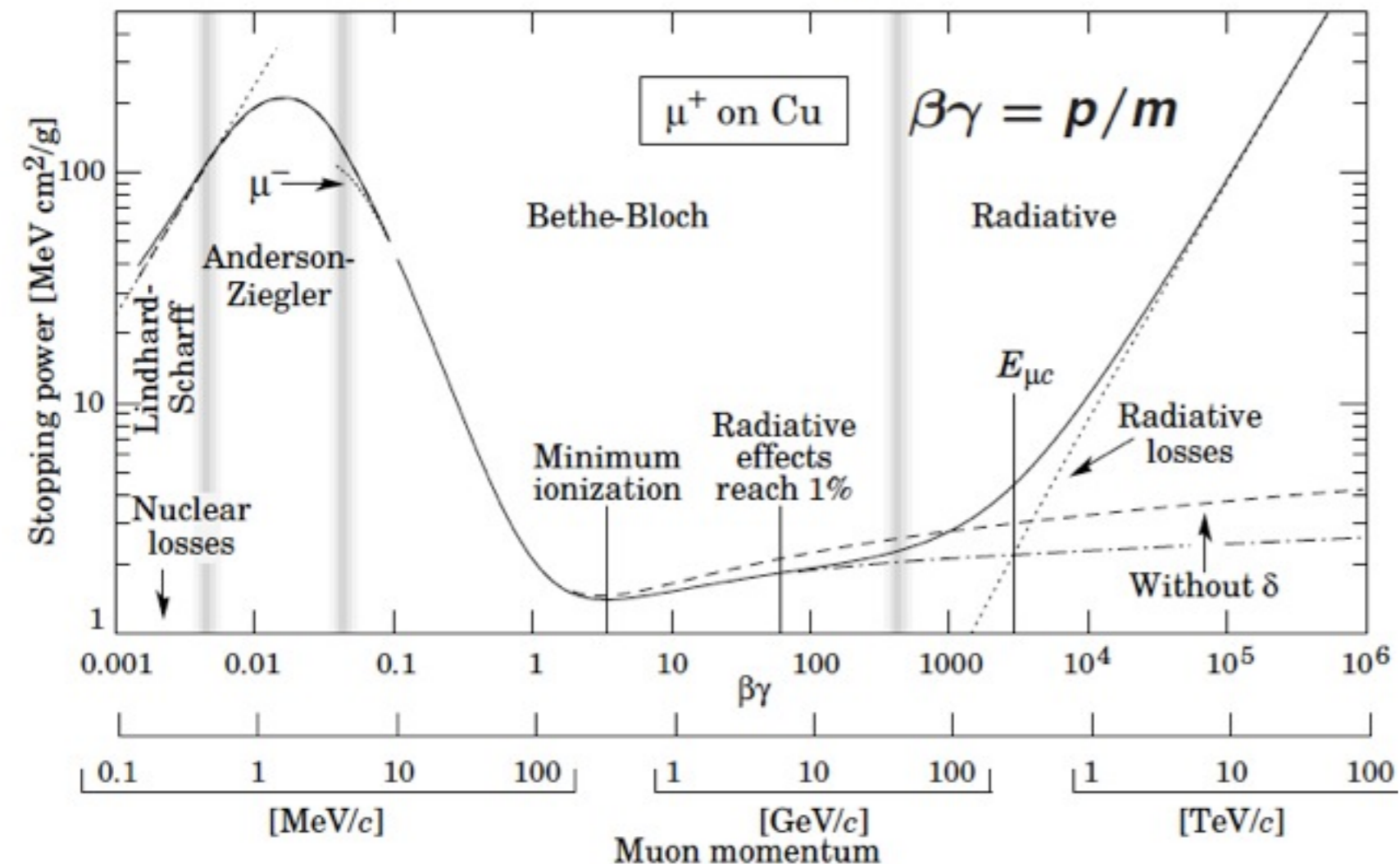

- Valid in intermediate energy range: $\sim 0.1 < \beta\gamma < \sim 1000$
 - at low energies: atomic effects
 - at high energies: radiative energy loss in addition
- Z/A Dependence: high energy loss in H**
- $1/\beta^2$ for low momenta: Heavy particles loose more energy**
- Minimum at $p/m \sim 3-4$: minimum ionizing particle MIP
- Logarithmic rise for high energy**
- Additional density effect due to polarization of absorber**

Important Constants

Symbol	Definition	Wert und/oder Dimension
α	Feinstrukturkonstante	1/137.03599976(50)
m	Masse des einfallenden Teilchens	MeV/c ²
E	Energie des Teilchens	MeV
T	kinetische Energie des Teilchens	MeV
$z \cdot e$	Ladung des Teilchens	$z \cdot 1.6021 \cdot 10^{-19} \text{ C}$
r_e	klassischer Elektronenradius	2.817940285(31) fm
N_A	Avogadro-Zahl	$6.02214199(47) \cdot 10^{-23} / \text{mol}$
$Z; A$	Atomzahl; Atomgewicht des Absorbers	—; g/mol
K	$4\pi N_A r_e m_e c^2$	0.307075 MeV cm ²
δ	Dichtekorrektur zur Ionisation	
E_p	Plasmaenergie	$28.816 \sqrt{\rho \langle Z/A \rangle} \text{ eV}$, ρ in g/cm ³
X_0	Strahlungslänge	g/cm ²
λ_a	Absorptionslänge	g/cm ²
T_{max}	Maximal übertragbare kinetische Energie	MeV
I	Mittlere Ionisationsenergie	eV
$E_c; E_{\mu c}$	Kritische Energie für Elektronen; Myonen	MeV; GeV

- Mean ionization energy:

$$I \sim 16 Z^{0.9} \text{ eV for } Z > 1$$

Material Dependence of Energy Loss

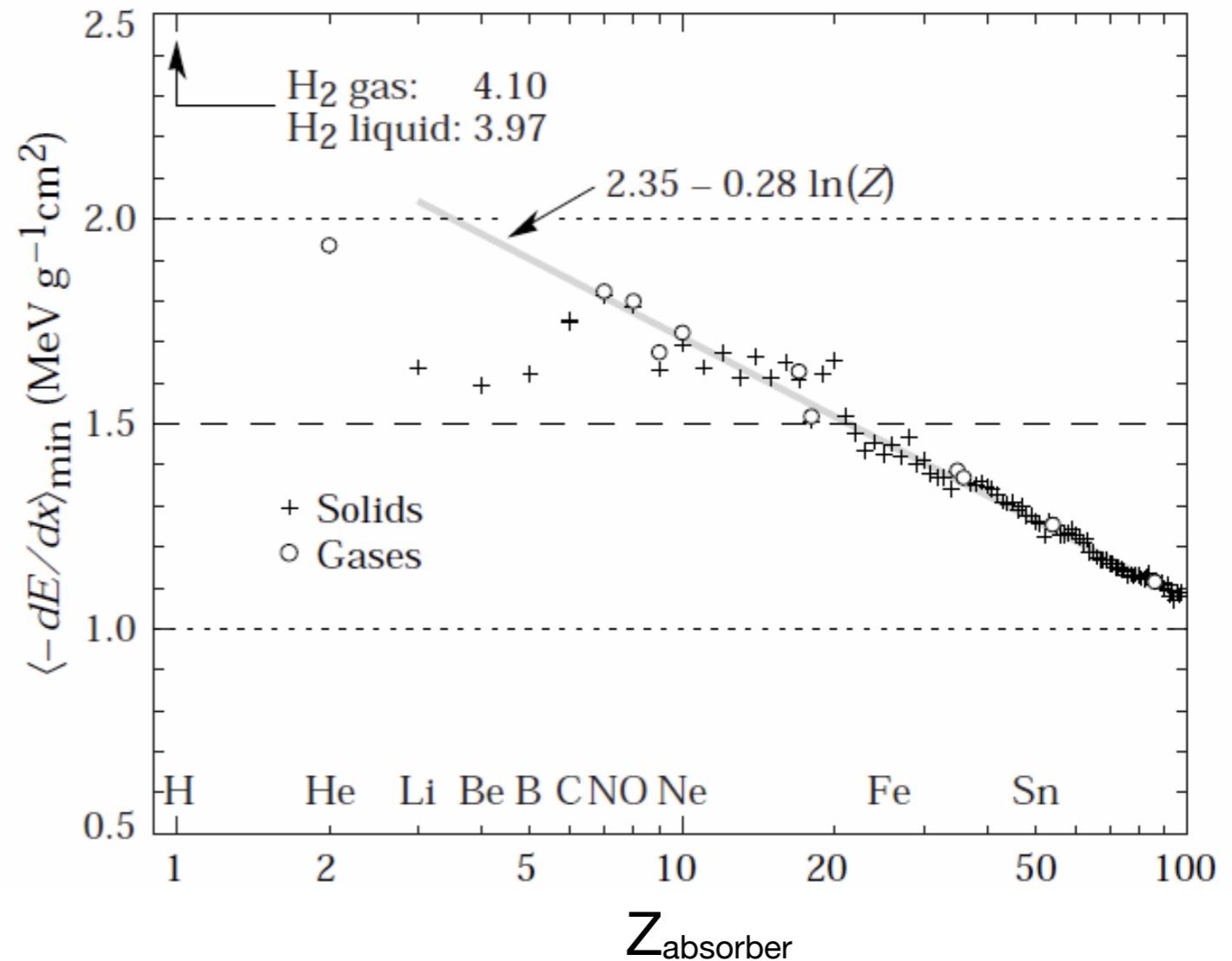
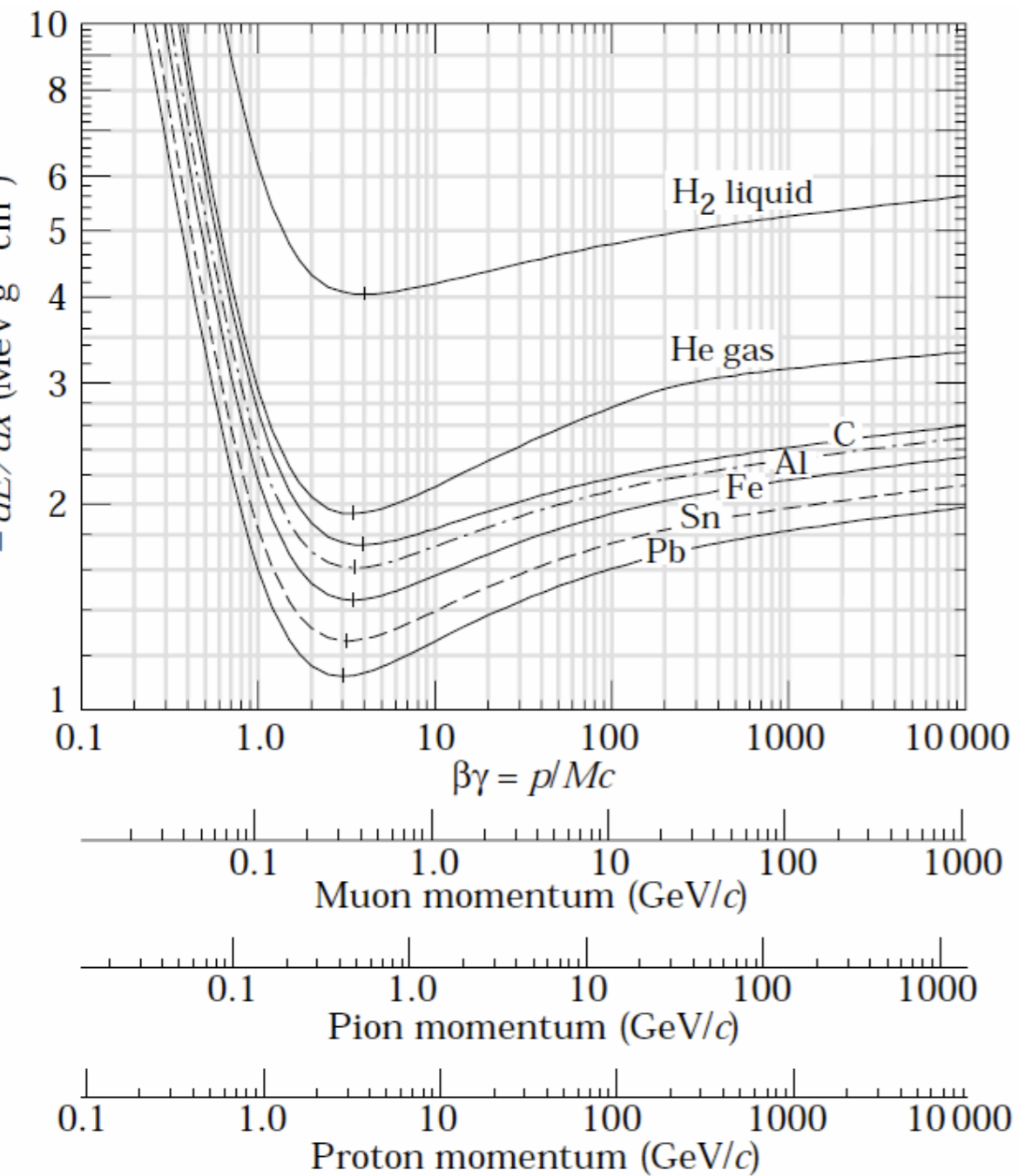

- Ballpark number to remember:
Energy loss of MIPs ($\beta\gamma \sim 3$):
1-2 MeV g⁻¹ cm² (exception: H)

Electrons & Photons: Radiation Length

- The relevant material constant: ***radiation length X_0***
 - Describes high-energy electrons and photons (energy loss via Bremsstrahlung and e^+e^- - pair creation)

Electrons & Photons: Radiation Length

- The relevant material constant: ***radiation length X_0***
 - Describes high-energy electrons and photons (energy loss via Bremsstrahlung and e^+e^- - pair creation)
 - Defined as the amount of matter that has to be traversed so that
 - an electron loses all but $1/e$ of its energy via Bremsstrahlung
 - $7/9$ of the mean free path of photons for pair creation

Electrons & Photons: Radiation Length

- The relevant material constant: **radiation length X_0**
 - Describes high-energy electrons and photons (energy loss via Bremsstrahlung and e^+e^- - pair creation)
 - Defined as the amount of matter that has to be traversed so that
 - an electron loses all but 1/e of its energy via Bremsstrahlung
 - 7/9 of the mean free path of photons for pair creation

empirical formula:
$$X_0 = \frac{716.4 A}{Z(1+Z) \ln(287/\sqrt{Z})} \frac{g}{cm^2} \propto \frac{A}{Z^2}$$

Electrons & Photons: Radiation Length

- The relevant material constant: **radiation length X_0**
 - Describes high-energy electrons and photons (energy loss via Bremsstrahlung and e^+e^- - pair creation)
 - Defined as the amount of matter that has to be traversed so that
 - an electron loses all but 1/e of its energy via Bremsstrahlung
 - 7/9 of the mean free path of photons for pair creation

empirical formula:
$$X_0 = \frac{716.4 A}{Z(1+Z) \ln(287/\sqrt{Z})} \frac{g}{cm^2} \propto \frac{A}{Z^2}$$

- Also relevant for the description of low-angle multiple scattering

Electrons & Photons: Radiation Length

- The relevant material constant: **radiation length X_0**
 - Describes high-energy electrons and photons (energy loss via Bremsstrahlung and e^+e^- - pair creation)
 - Defined as the amount of matter that has to be traversed so that
 - an electron loses all but 1/e of its energy via Bremsstrahlung
 - 7/9 of the mean free path of photons for pair creation

empirical formula:
$$X_0 = \frac{716.4 A}{Z(1+Z) \ln(287/\sqrt{Z})} \frac{g}{cm^2} \propto \frac{A}{Z^2}$$

- Also relevant for the description of low-angle multiple scattering
- Usually given in g/cm^2 , typical values for some materials:
 - Air: $36.66 g/cm^2$, corresponds to $\sim 300 m$
 - Water: $36.08 g/cm^2$, corresponds to $\sim 36 cm$
 - Aluminum: $24.01 g/cm^2$, corresponds to $8.9 cm$
 - Tungsten: $6.76 g/cm^2$, corresponds to $0.35 cm$

Electrons: Energy Loss

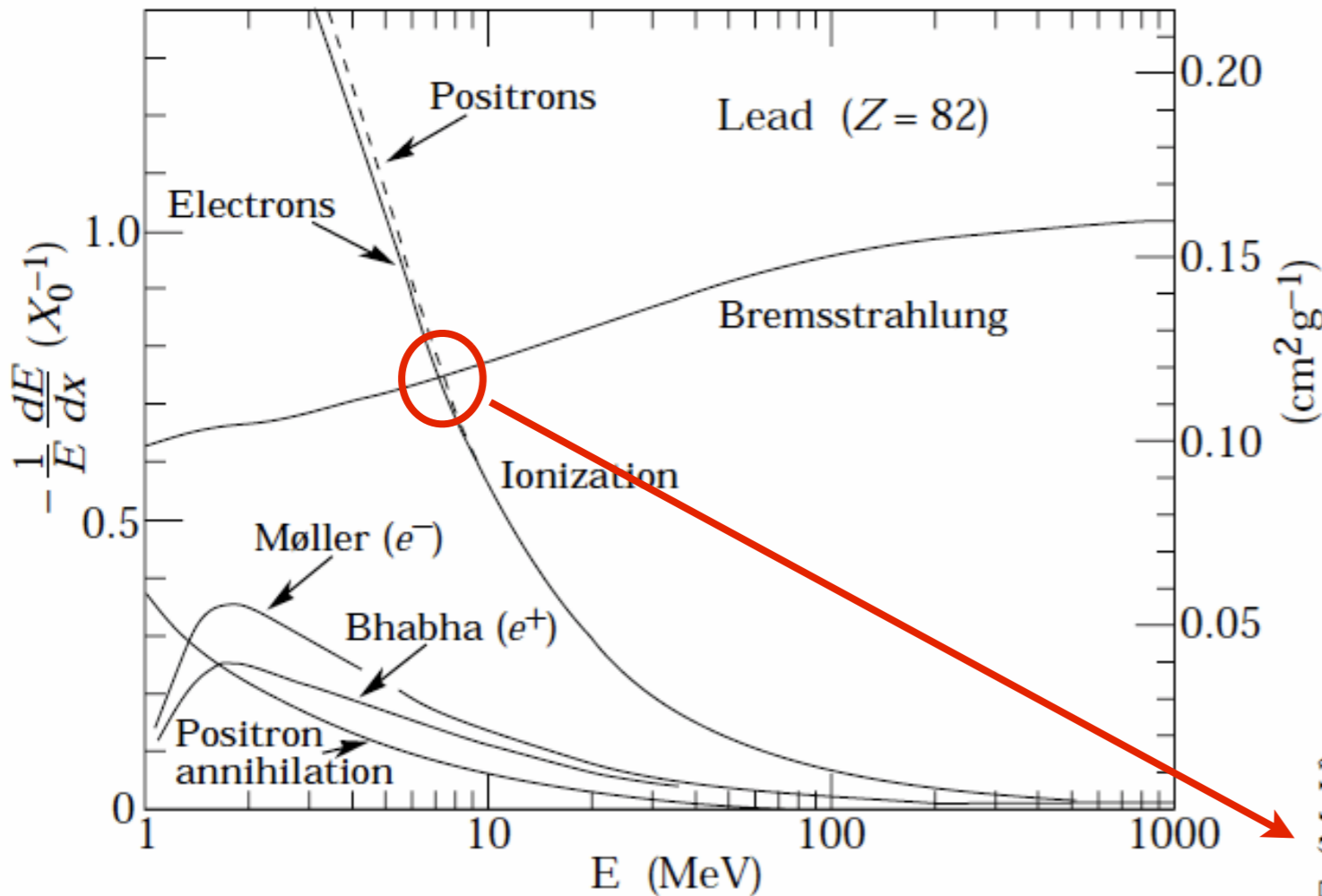

- Bremsstrahlung dominates at high energies
- At low energies: Ionization, scattering

- Critical energy: The energy where ionization and radiative energy loss are equal

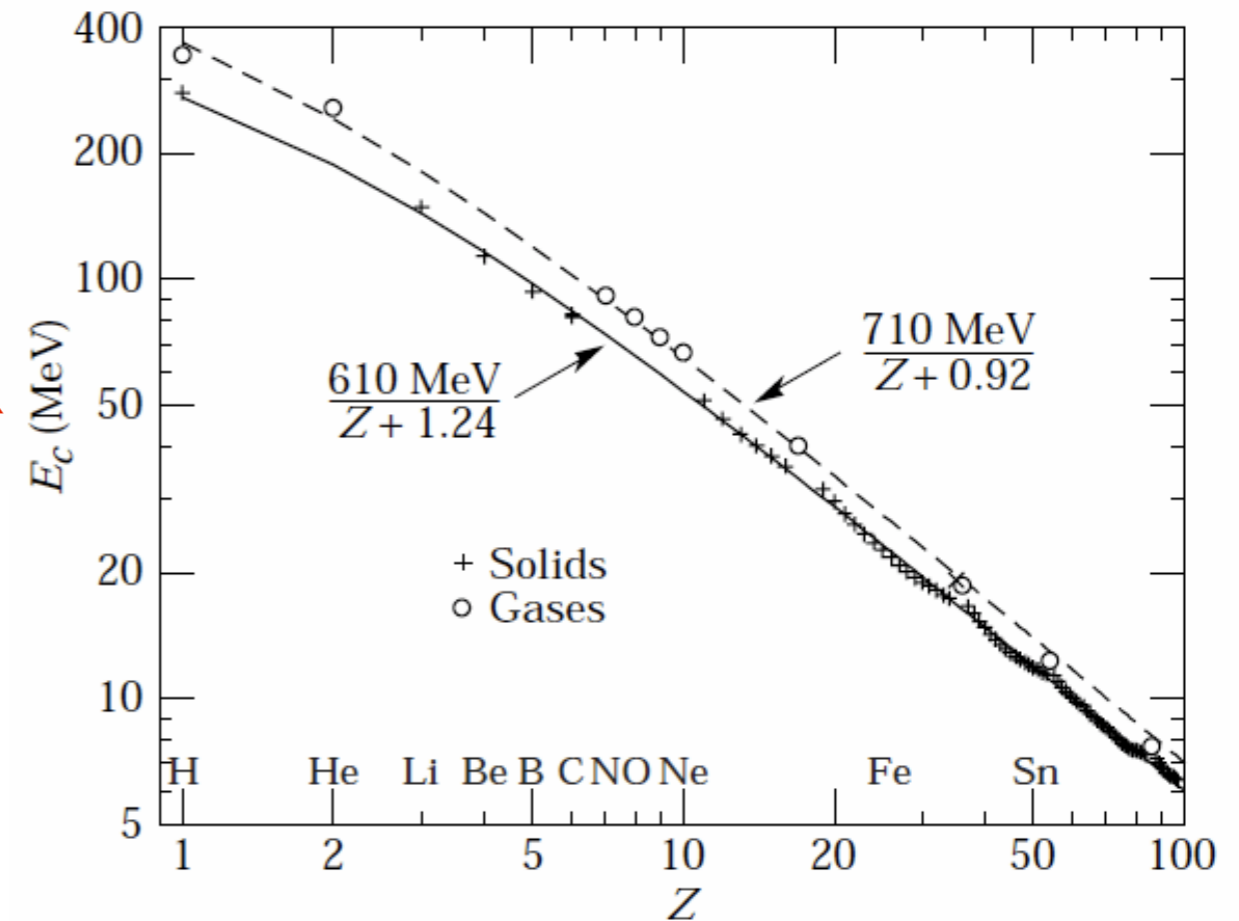

Photons: Interaction

Photo effect

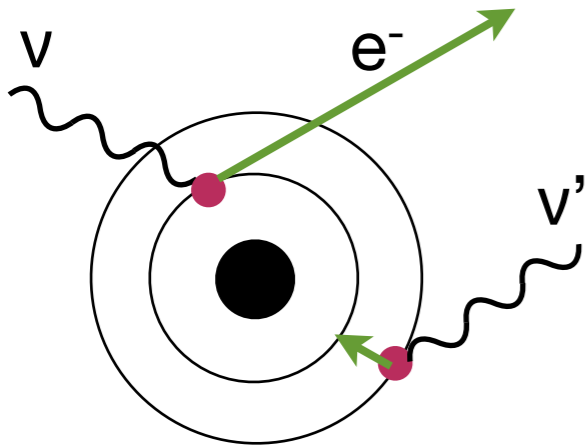

Compton scattering

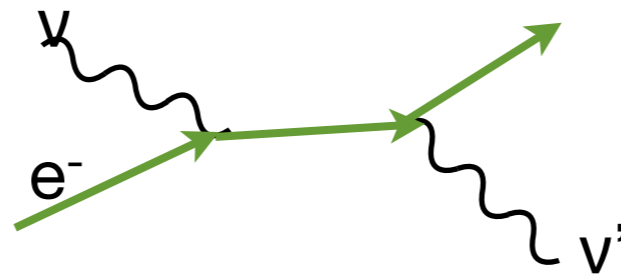

Pair creation

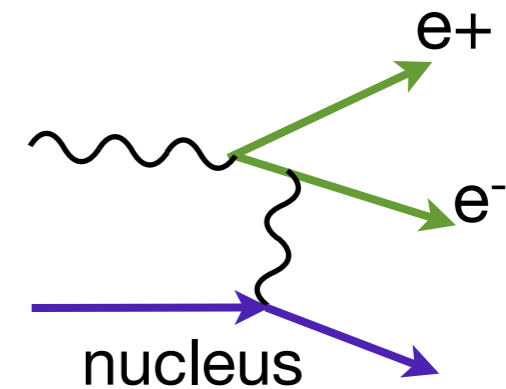

energy threshold:
 $2 m_e = \sim 1.022 \text{ MeV}$

Photons: Interaction

Photo effect

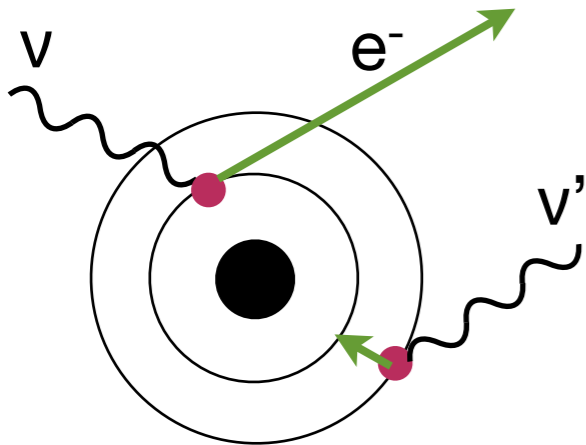

Compton scattering

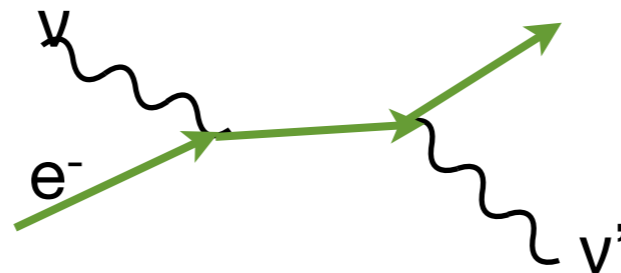

Pair creation

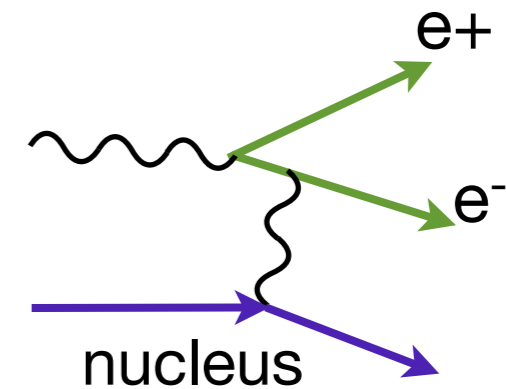

energy threshold:
 $2 m_e = \sim 1.022 \text{ MeV}$

- In contrast to dE/dx of charged particles:
“all-or-nothing” reactions with a certain probability

Photons: Interaction

Photo effect

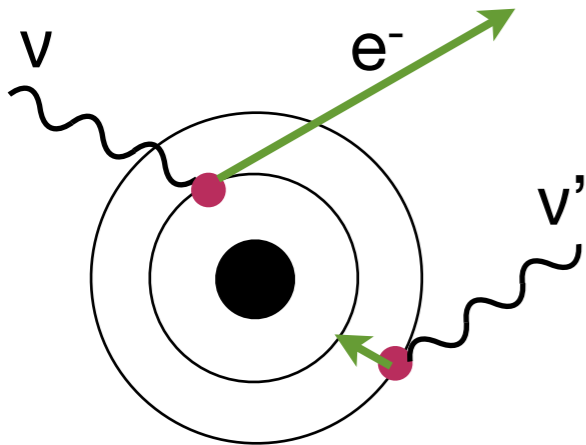

Compton scattering

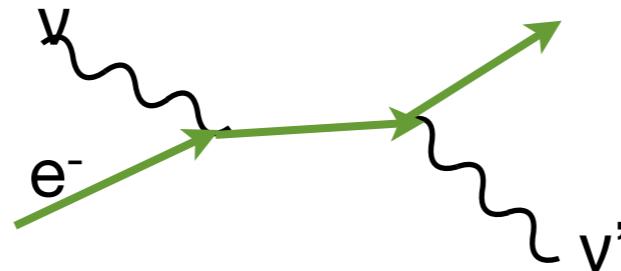

Pair creation

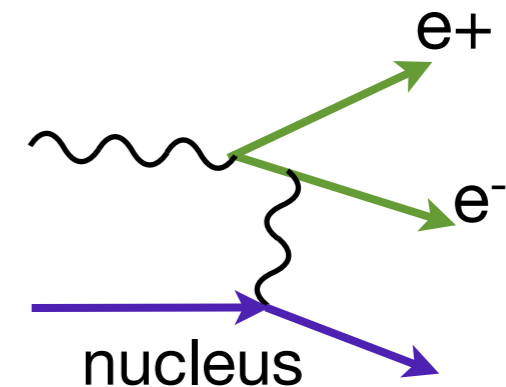

energy threshold:
 $2 m_e = \sim 1.022 \text{ MeV}$

- In contrast to dE/dx of charged particles:
“all-or-nothing” reactions with a certain probability

⇒ Decrease of photon intensity with material thickness

$$I(x) = I_0 e^{-\mu x}$$

Photons in Matter

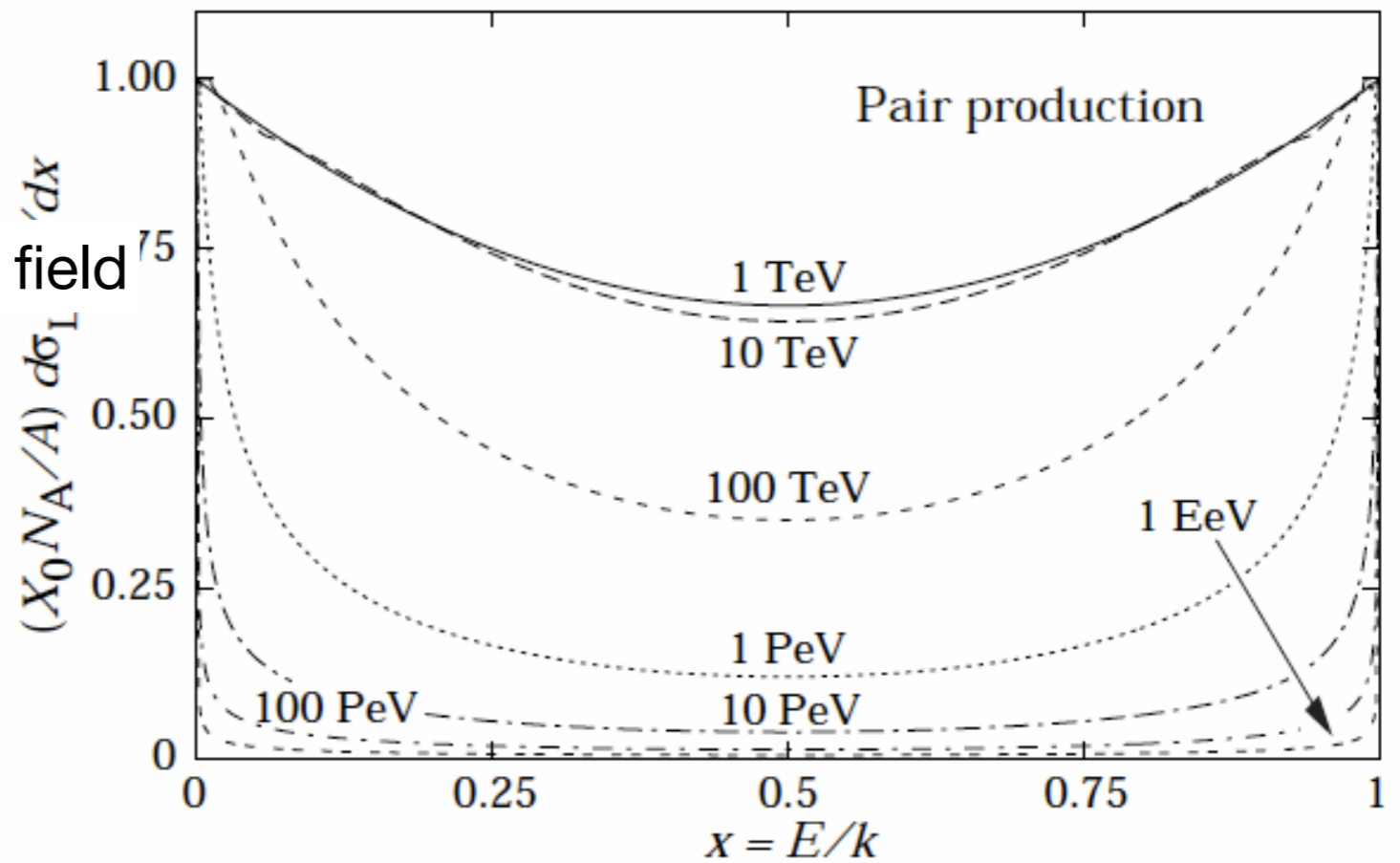
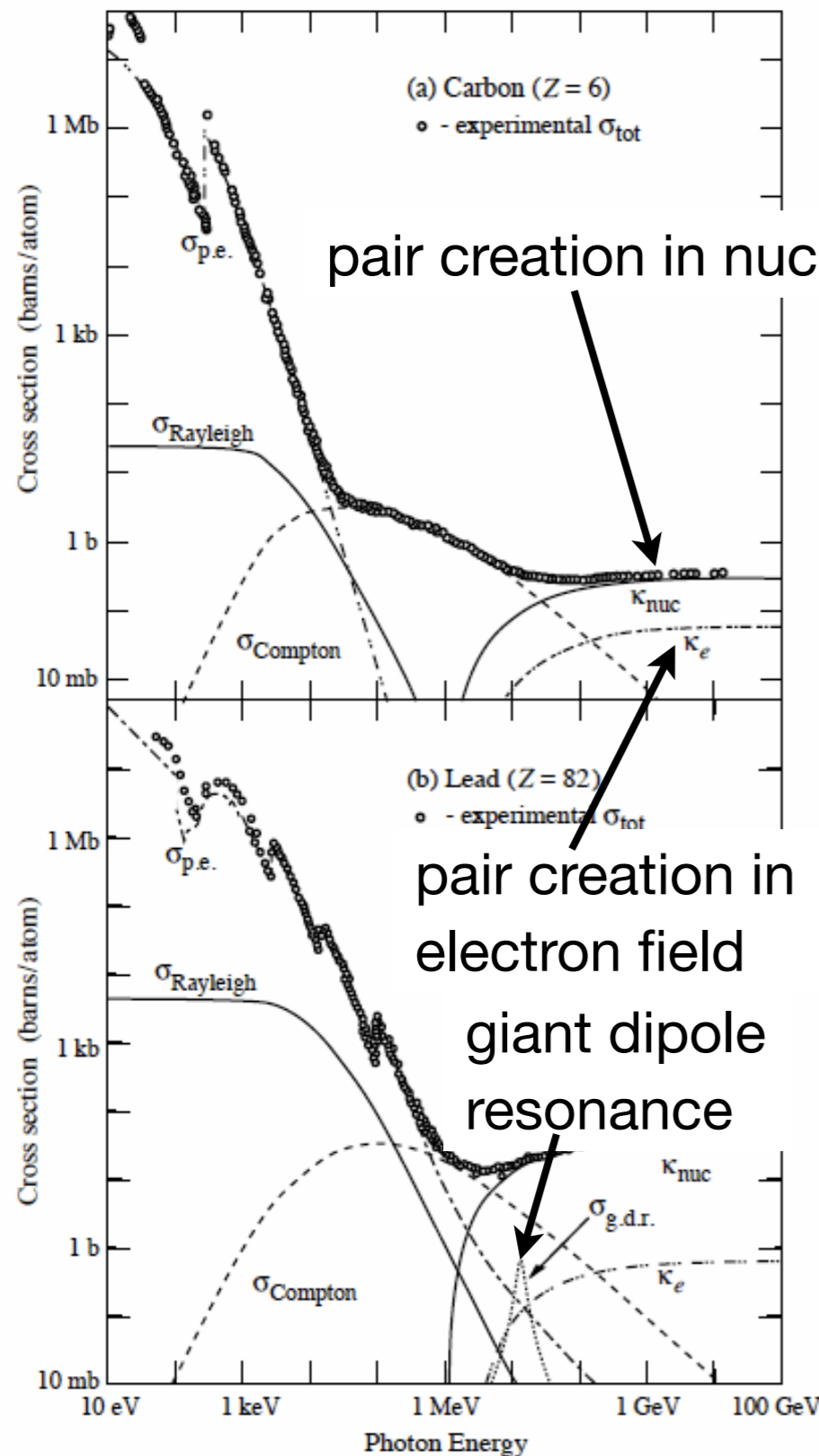

- At high energies pair production dominates
- Lower energies:
 - photo-electric effect
 - coherent scattering: Rayleigh scattering
 - Compton scattering
 - nuclear excitation

Electromagnetic Cascades

- Highly energetic electrons and photons (energies substantially above the pair creation threshold, i.e. several MeV) lead to electromagnetic showers in matter:
 - A combination of Bremsstrahlung und pair creation until the initial energy is used up

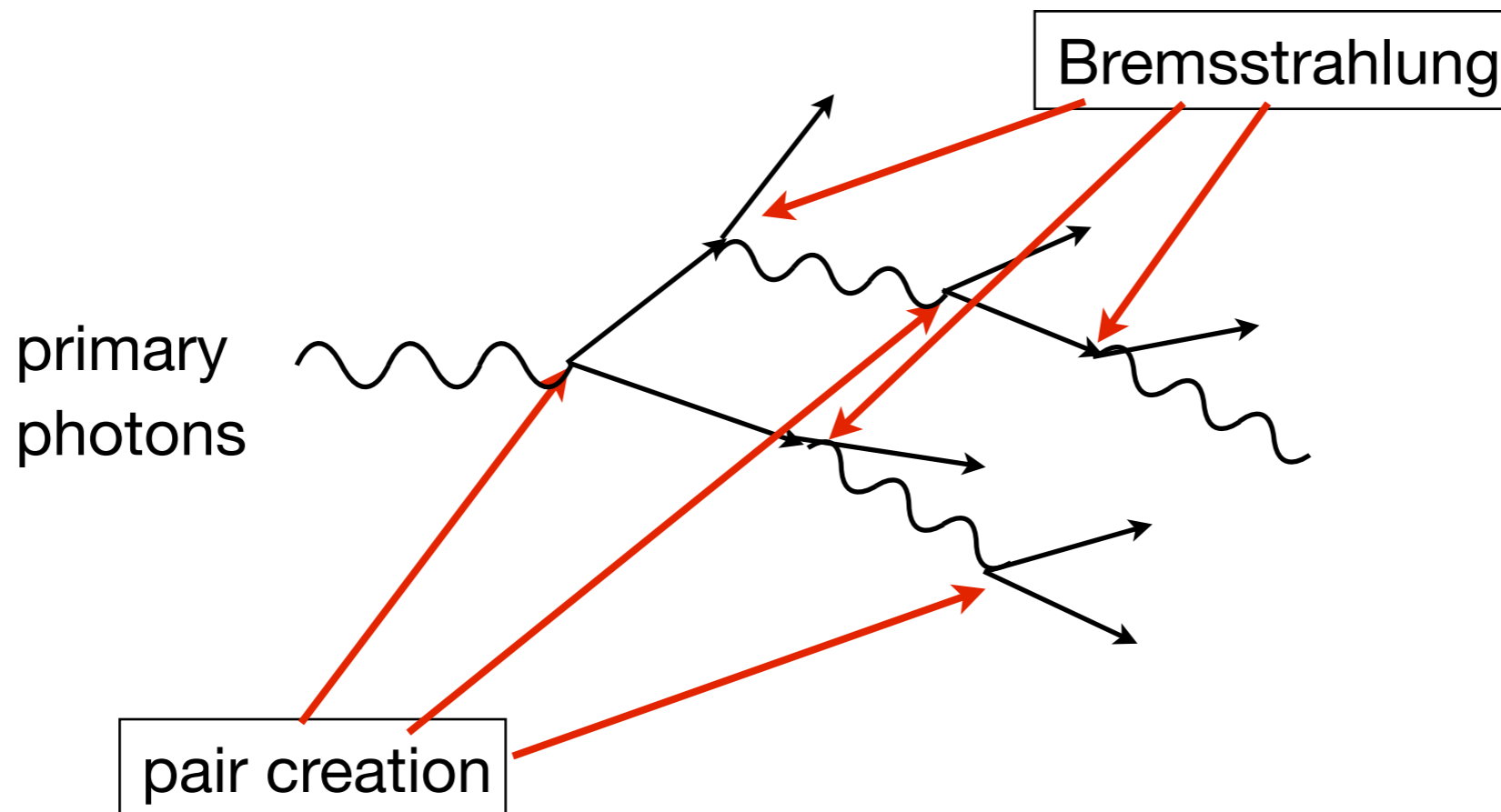

Particle Showers

- Highly energetic charged particles and photons from space create a shower in the atmosphere
- A cascade of particles, the number of particles is proportional to the energy of the primary particle: 1-1.5 particles / GeV in shower maximum

shower of a primary proton

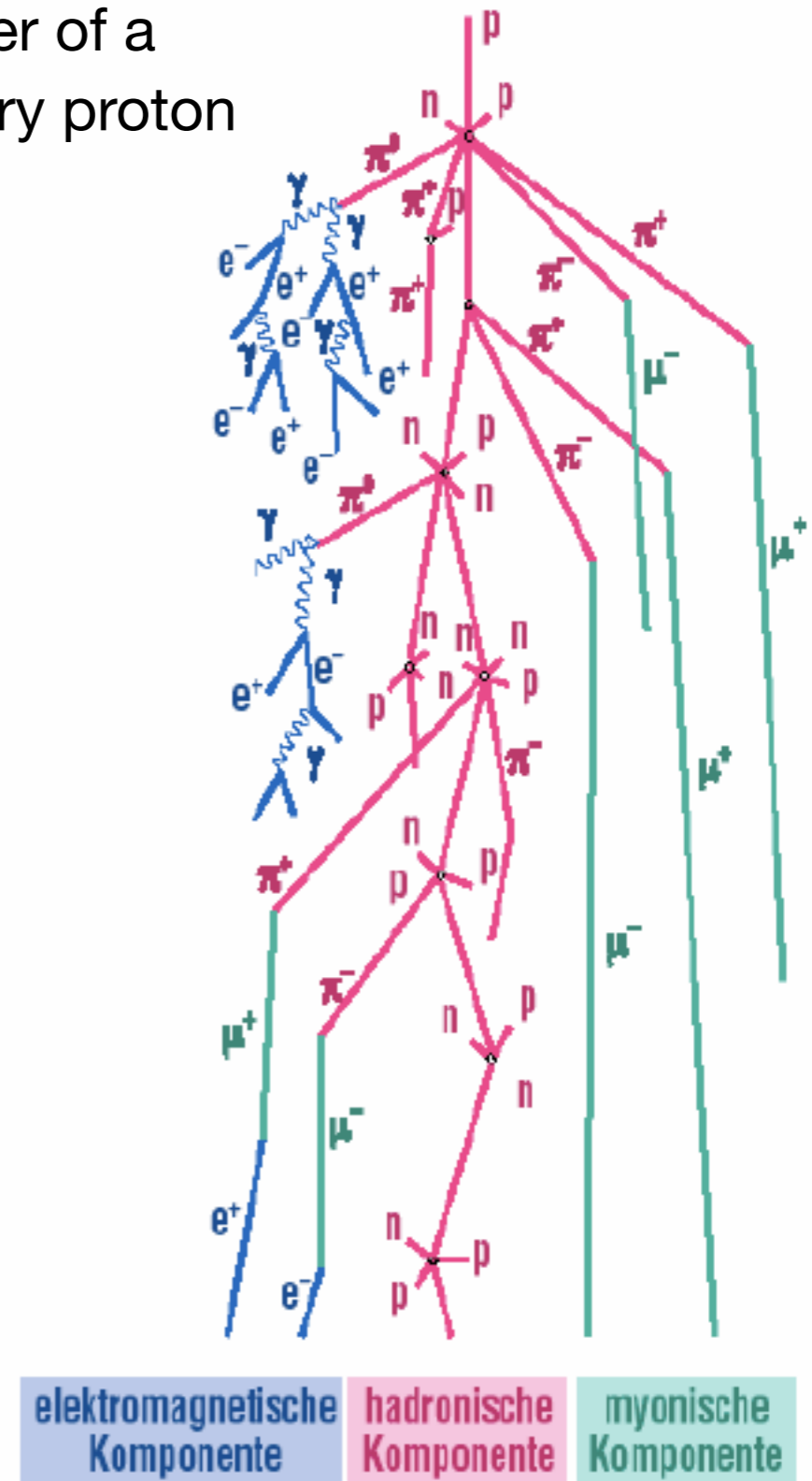

Particle Showers

- Highly energetic charged particles and photons from space create a shower in the atmosphere
- A cascade of particles, the number of particles is proportional to the energy of the primary particle: 1-1.5 particles / GeV in shower maximum

Also hadronic showers have mostly EM-character at very high energy

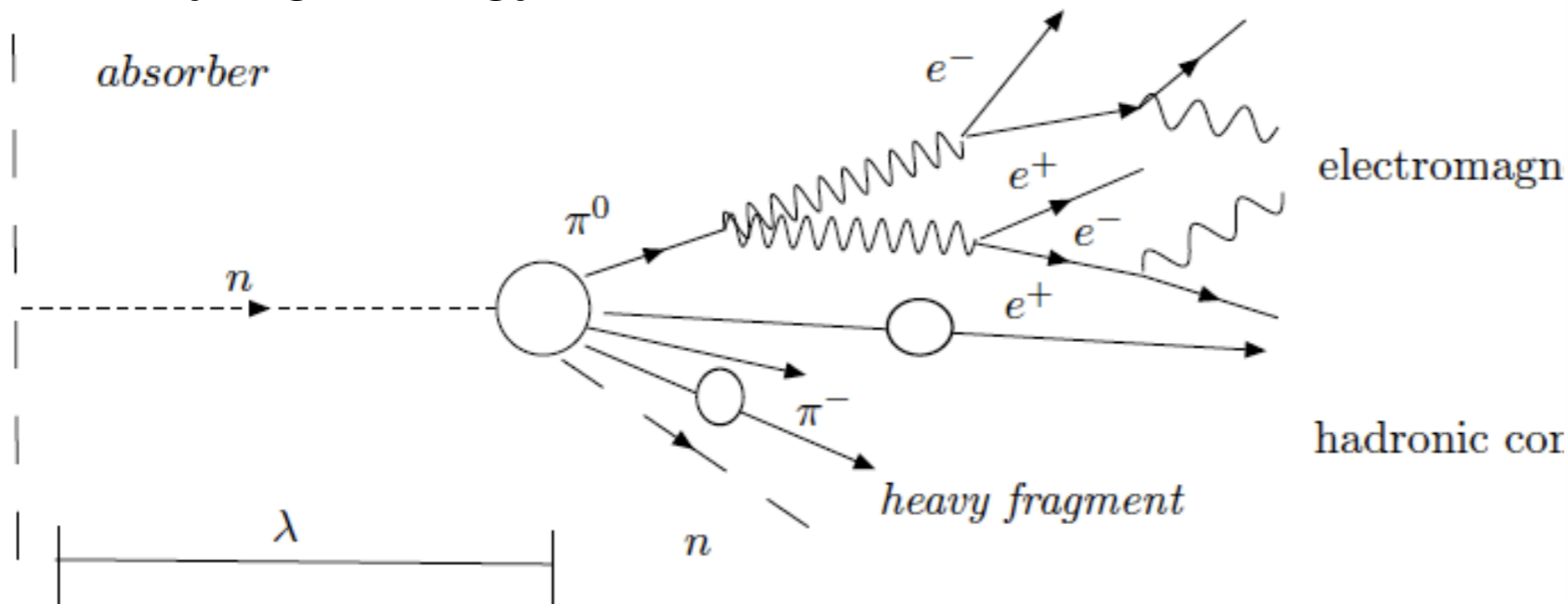

shower of a primary proton

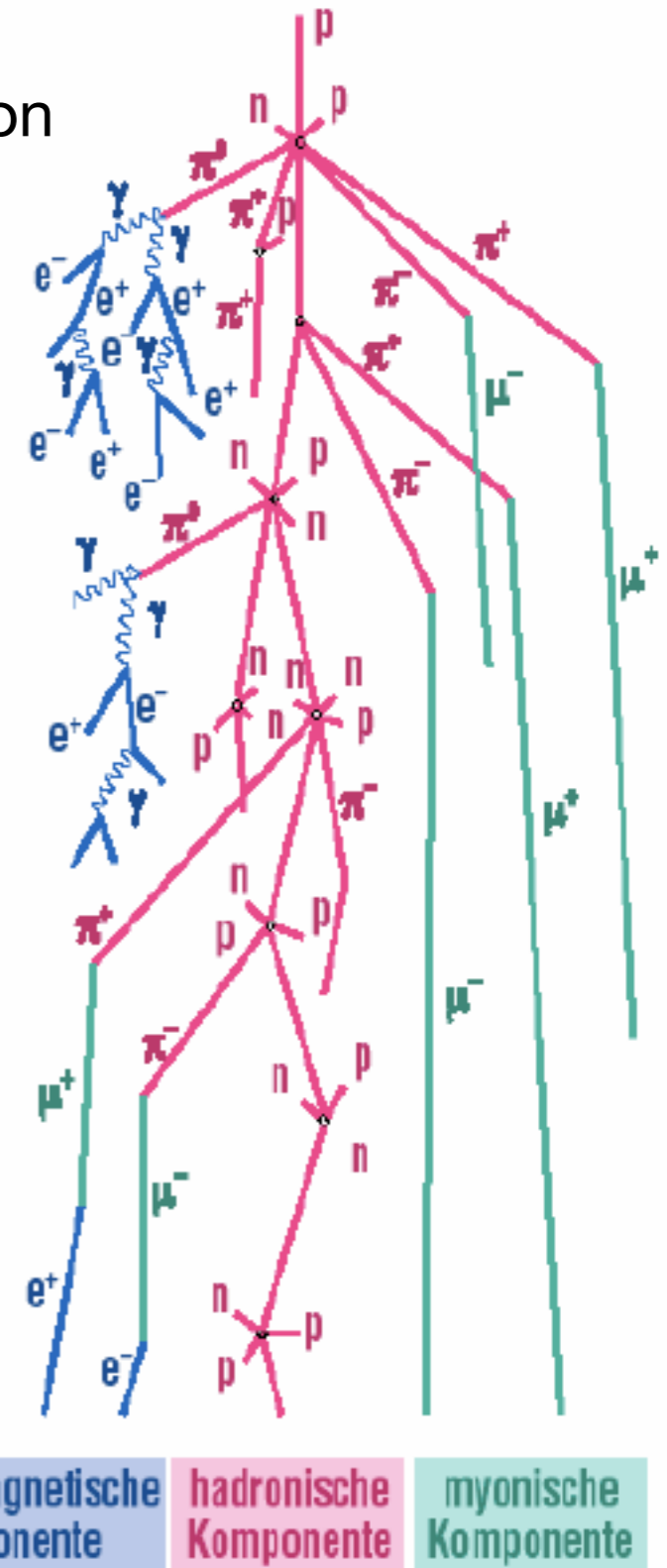

Cherenkov-Light: “Supersonic Boom” with Photons

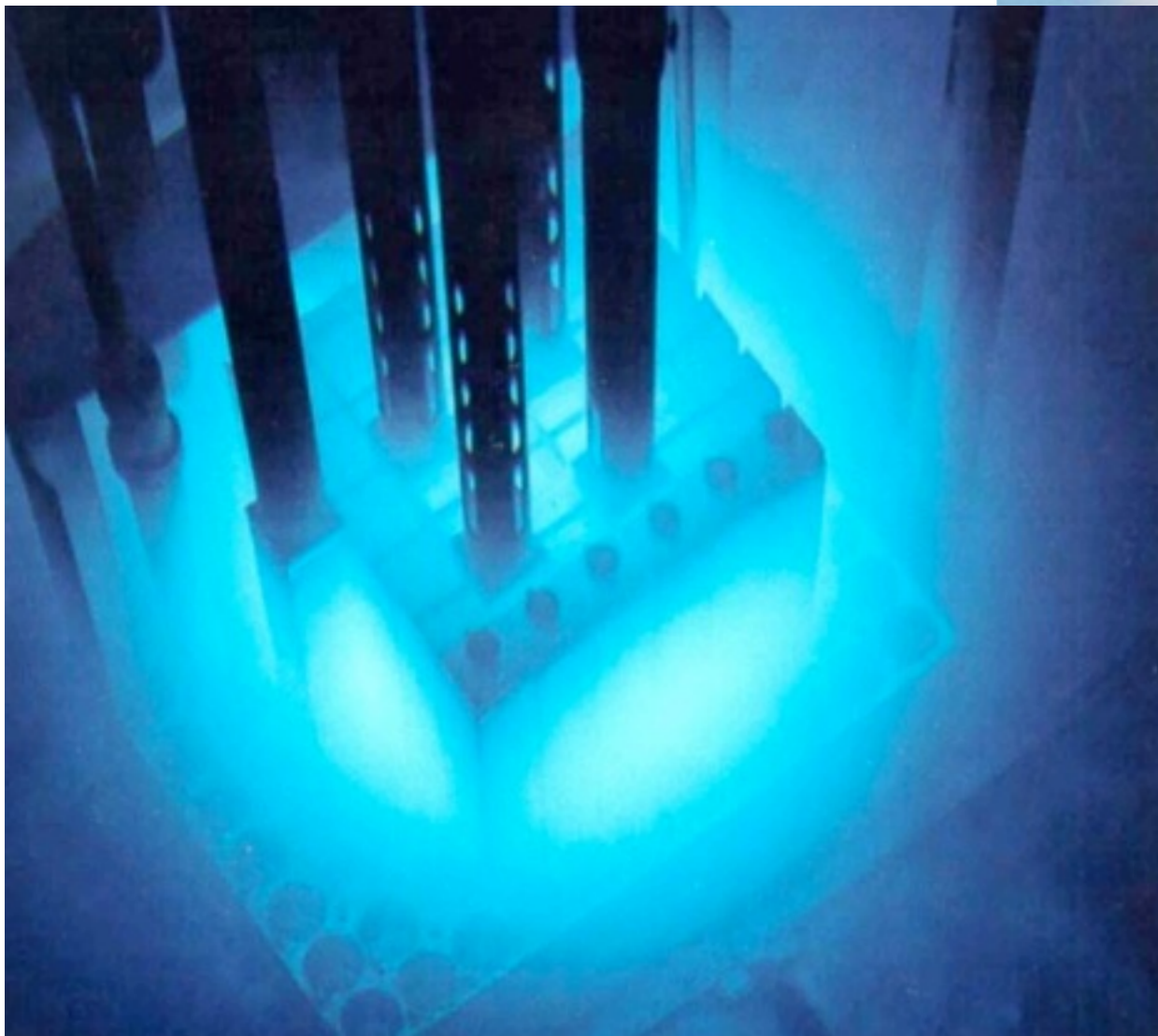

Cherenkov Light

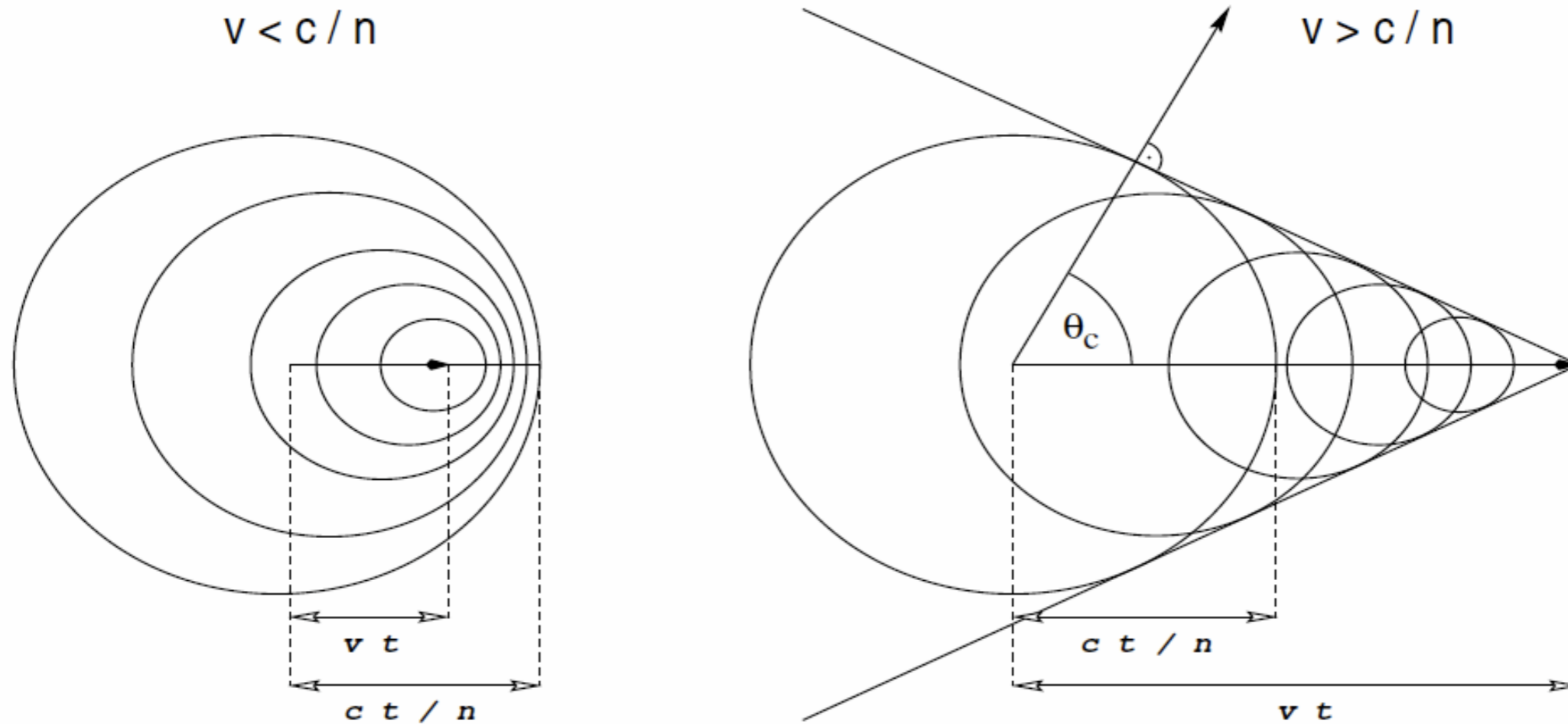

D. Kranich,
Dissertation

- Emission of photons by charged particles which are faster than the speed of light in the medium: constructive interference

Emission with a characteristic angle:

$$\cos\theta_c = \frac{ct/n}{vt} = \frac{1}{n\beta}$$

Detection Methods



Ionization Chamber: A Classic

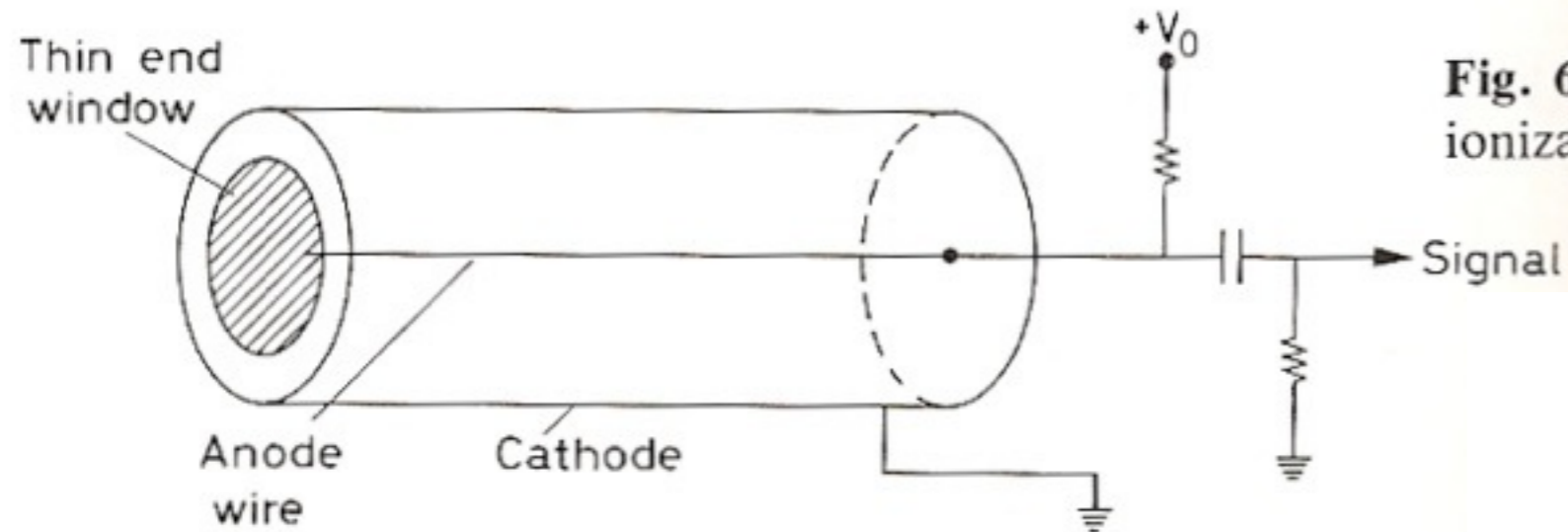
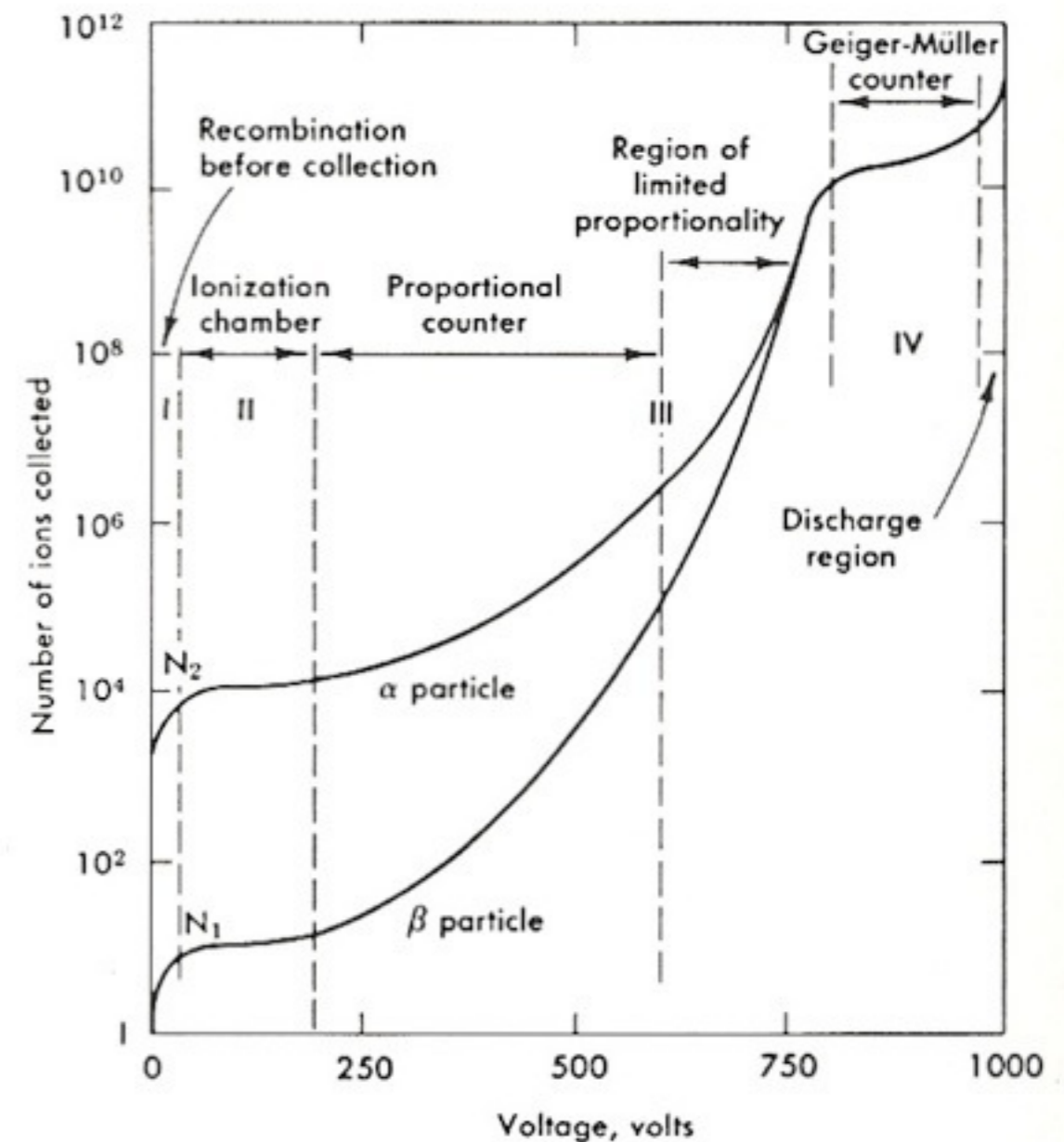
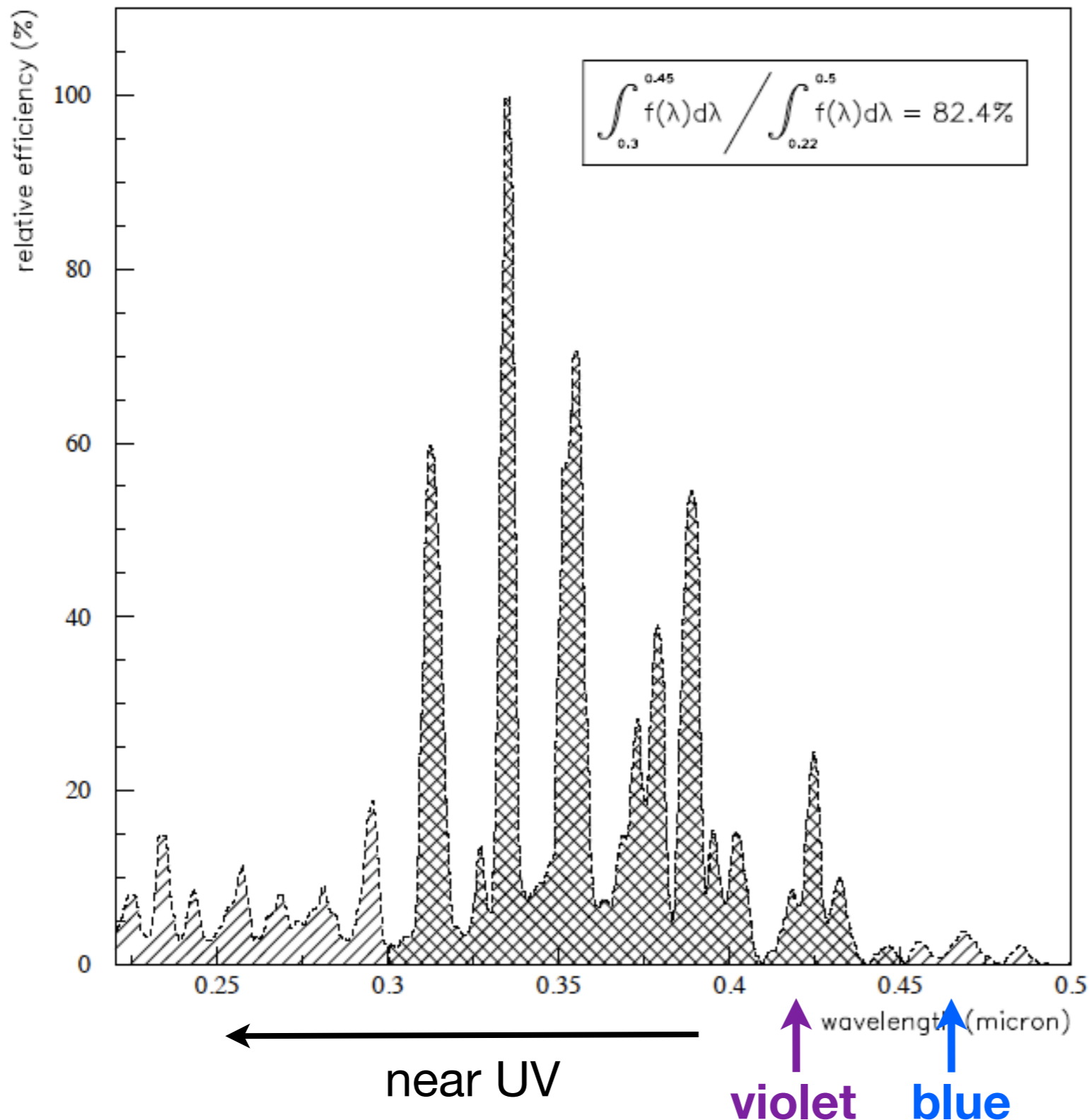

Fig. 6.1. Ionization

- Passage of particles creates electron-ion pairs in the gas volume
- Electrons are accelerated by strong electric field - avalanche multiplication takes place
- Depending on the voltage the signal is either proportional to the originally deposited charge, or goes into saturation



Fluorescence of Air



- Excitation of nitrogen in the atmosphere (2P - orbital of N_2 , 1N orbital of N_2^+)
- 80% of the photons are emitted in the range of 300 nm bis 450 nm
- Only $\sim 5 \times 10^{-5}$ of all deposited energy in air is emitted as fluorescence photons
 - Emission is isotropic: Can only be used for very high energies!

Detection of Photons: The Photo-Multiplier

- The classic way to detect visible (or near-visible) photons:

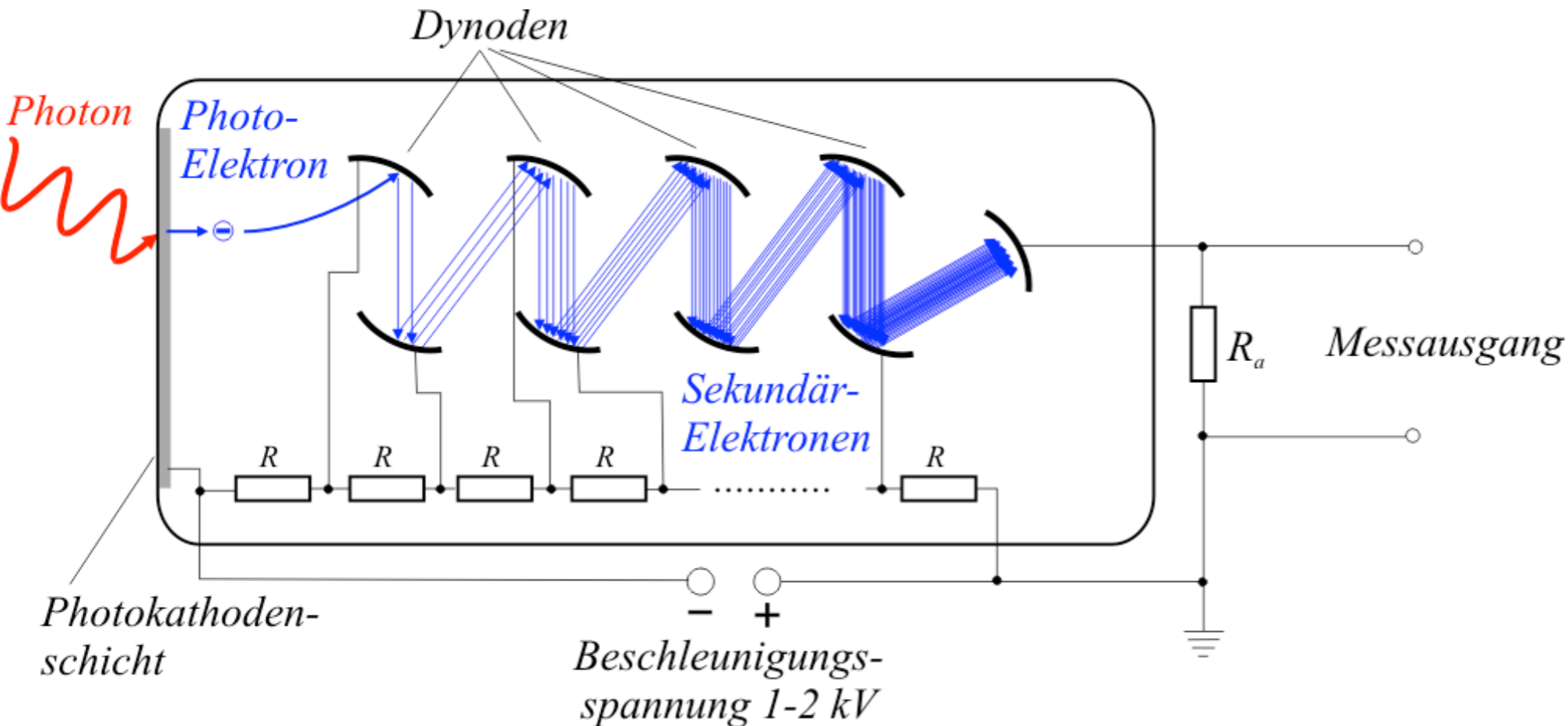

- Conversion of the photon to a photo-electron on a photo-cathode
 - Amplification of single-electron signal to a detectable signal with several dynodes
- Suited for a wide range of wavelengths ranging from UV to IR, good efficiency, up to ~ 25% (with special techniques up to ~ 40%), single photons can be detected
 - Large active areas are possible: SuperKamiokande uses PMTs with an active area 460 mm in diameter

Photon Detection with Silicon

- Silicon detectors can also be used to detect visible photons, but:
 - Photo effect only creates a single electron-hole pair (very different from the situation with charged particles): Amplification is crucial!
 - ▶ The usual charge amplification of up to ~ 100 reachable in silicon is insufficient to detect single photons with high efficiency

Photon Detection with Silicon

- Silicon detectors can also be used to detect visible photons, but:
 - Photo effect only creates a single electron-hole pair (very different from the situation with charged particles): Amplification is crucial!
 - ▶ The usual charge amplification of up to ~ 100 reachable in silicon is insufficient to detect single photons with high efficiency

Avalanche Photo Diode APD

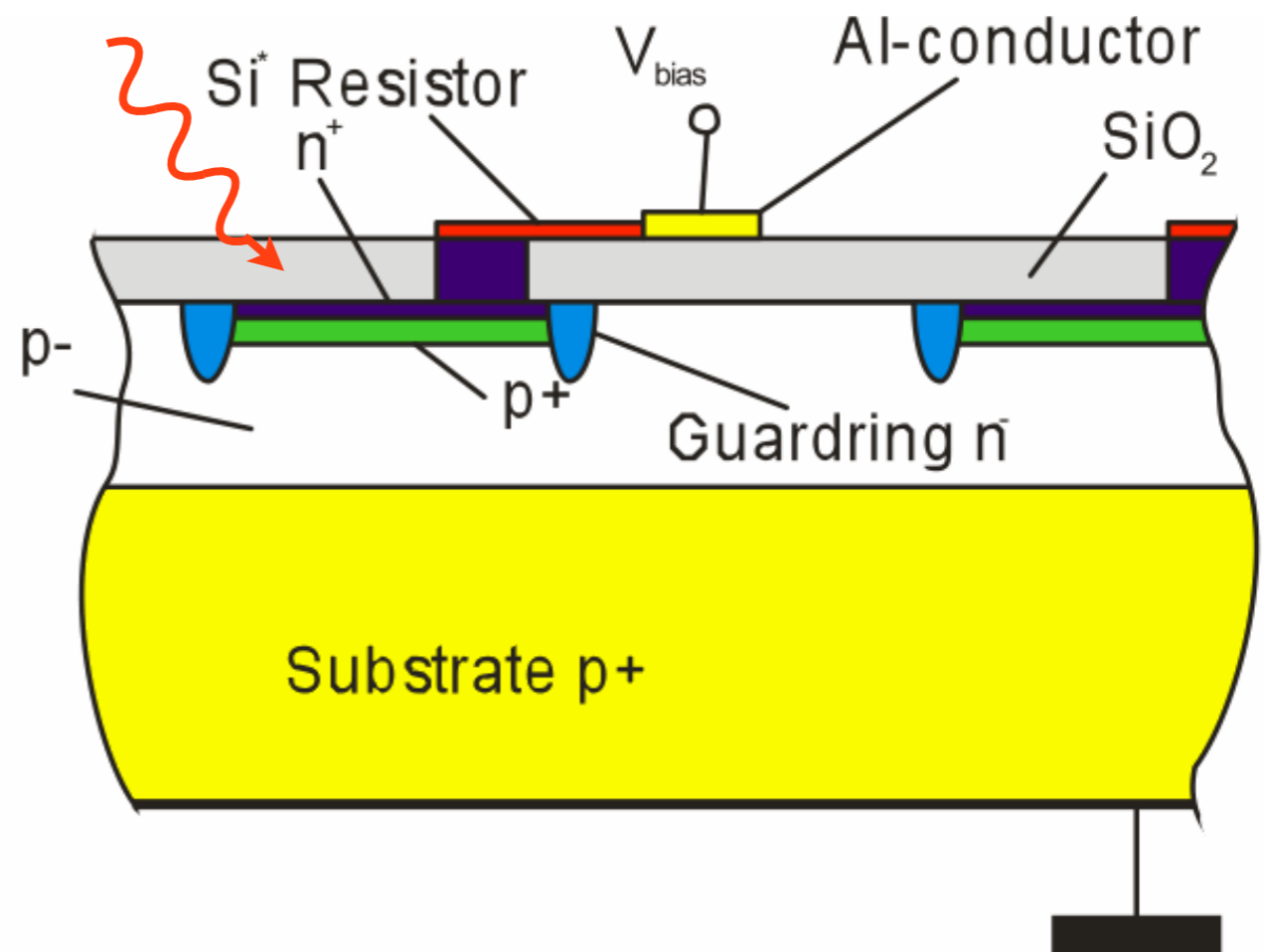
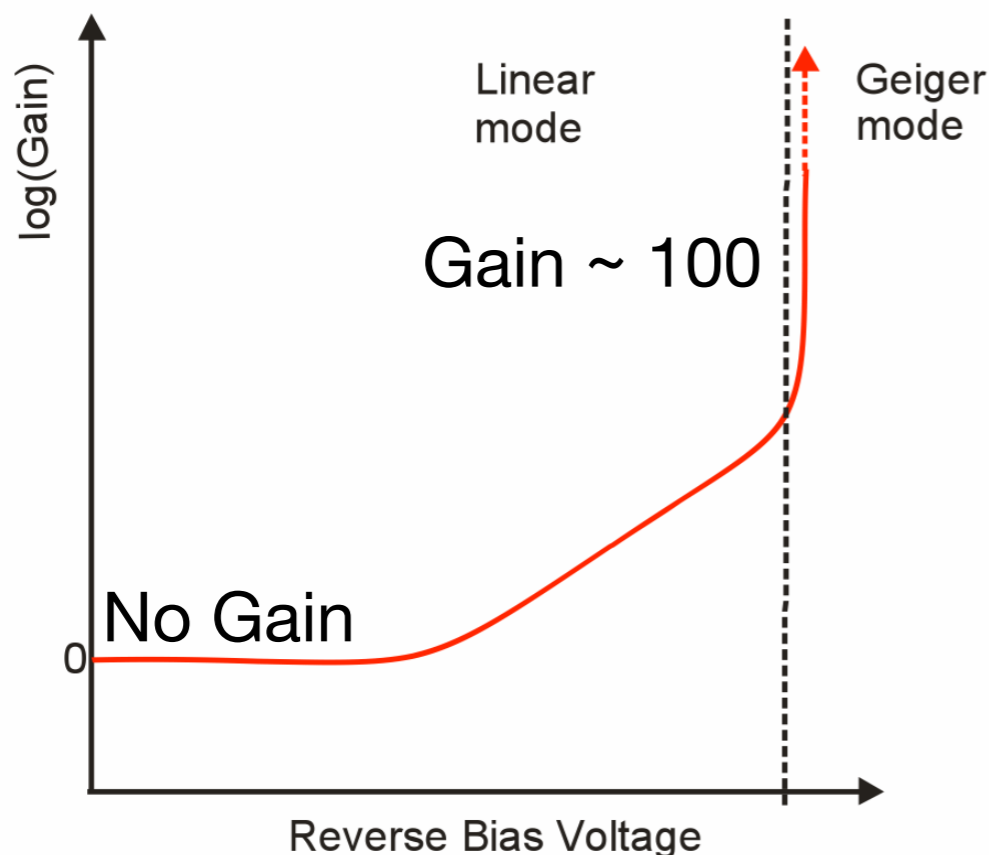

New Photon Sensors: Silicon Photomultipliers

- Highest amplification ($\sim 10^6$) by running APDs in Geiger mode: a single photon triggers a discharge, the diode operates in digital mode: Yes/No, no dependence of the current on the number of photons

New Photon Sensors: Silicon Photomultipliers

- Highest amplification ($\sim 10^6$) by running APDs in Geiger mode: a single photon triggers a discharge, the diode operates in digital mode: Yes/No, no dependence of the current on the number of photons
- The trick: Put many small APDs on a chip, read out the summed-up signal
 - Easy handling: Only one channel (as a PMT, hence the name)
 - Extreme amplification: Detection of single photons not a problem!

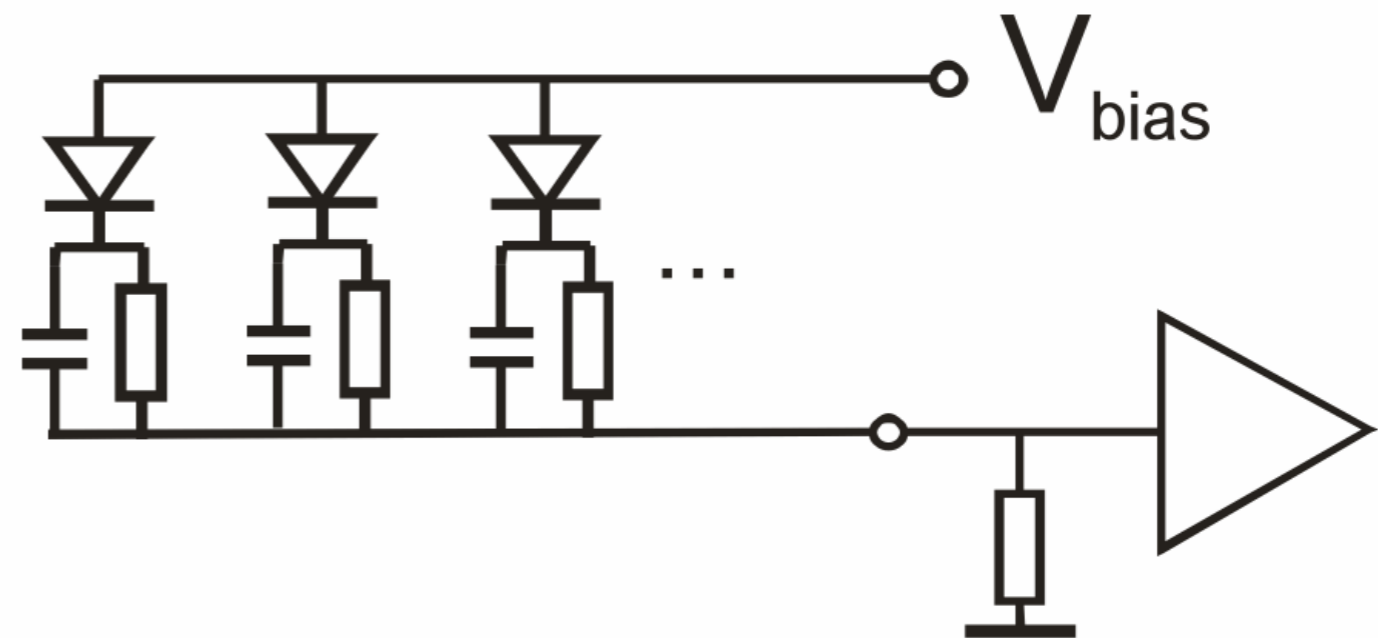
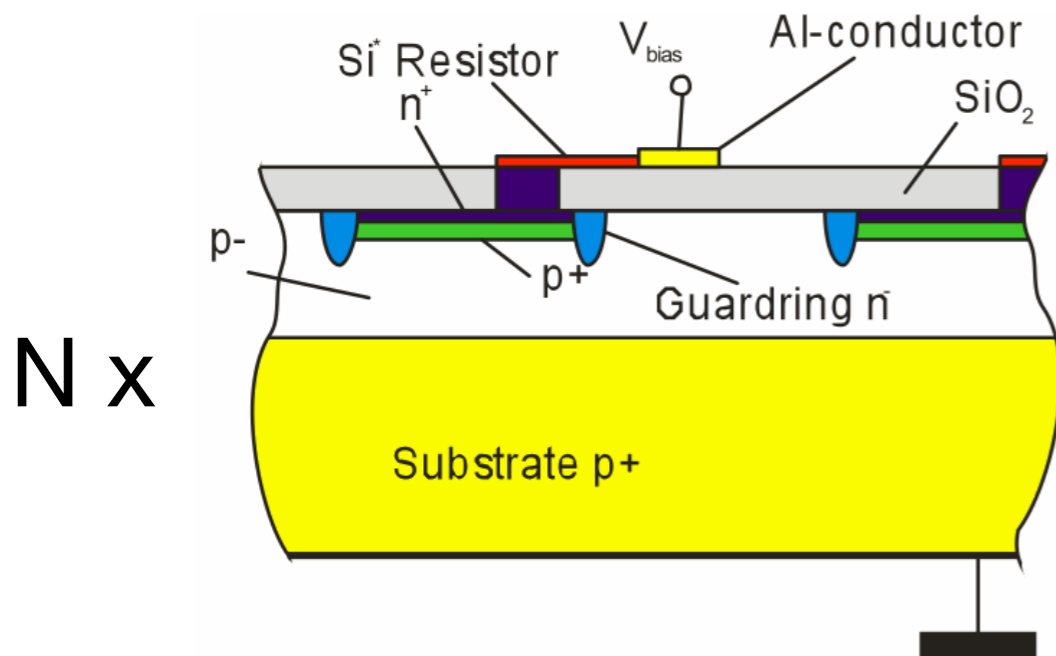

Silicon Photomultiplier: SiPM

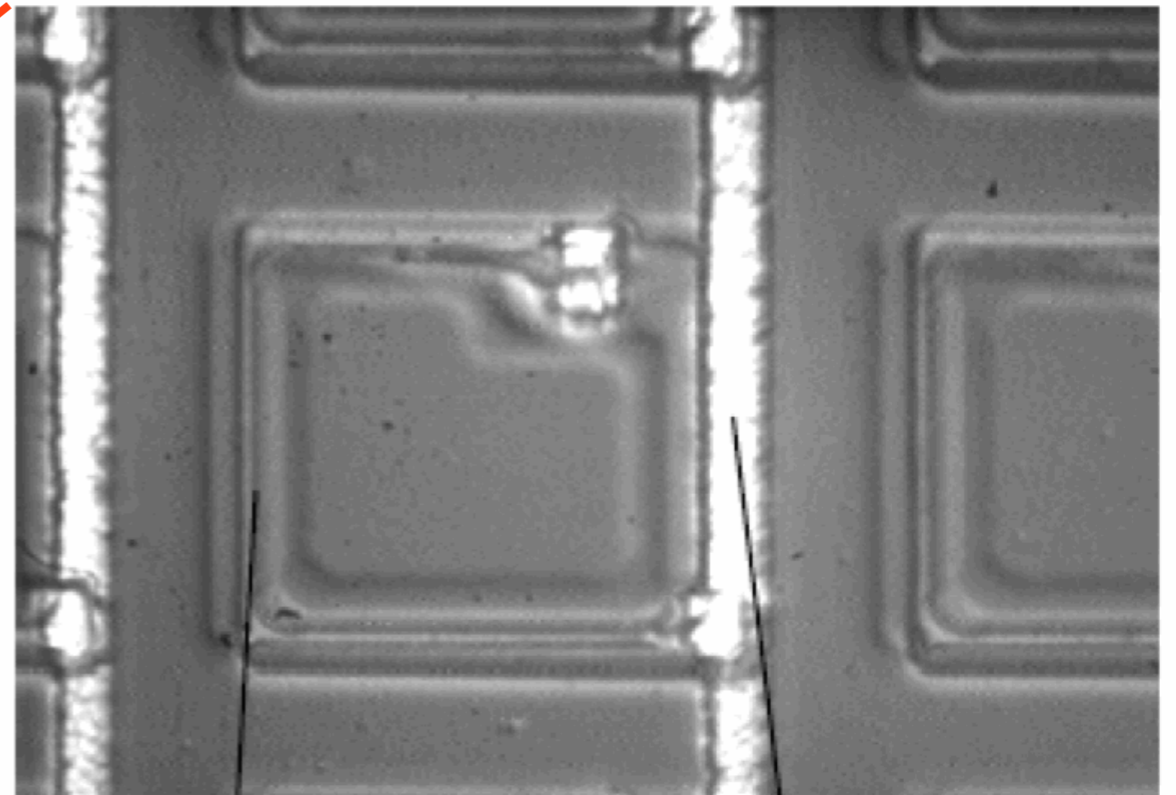
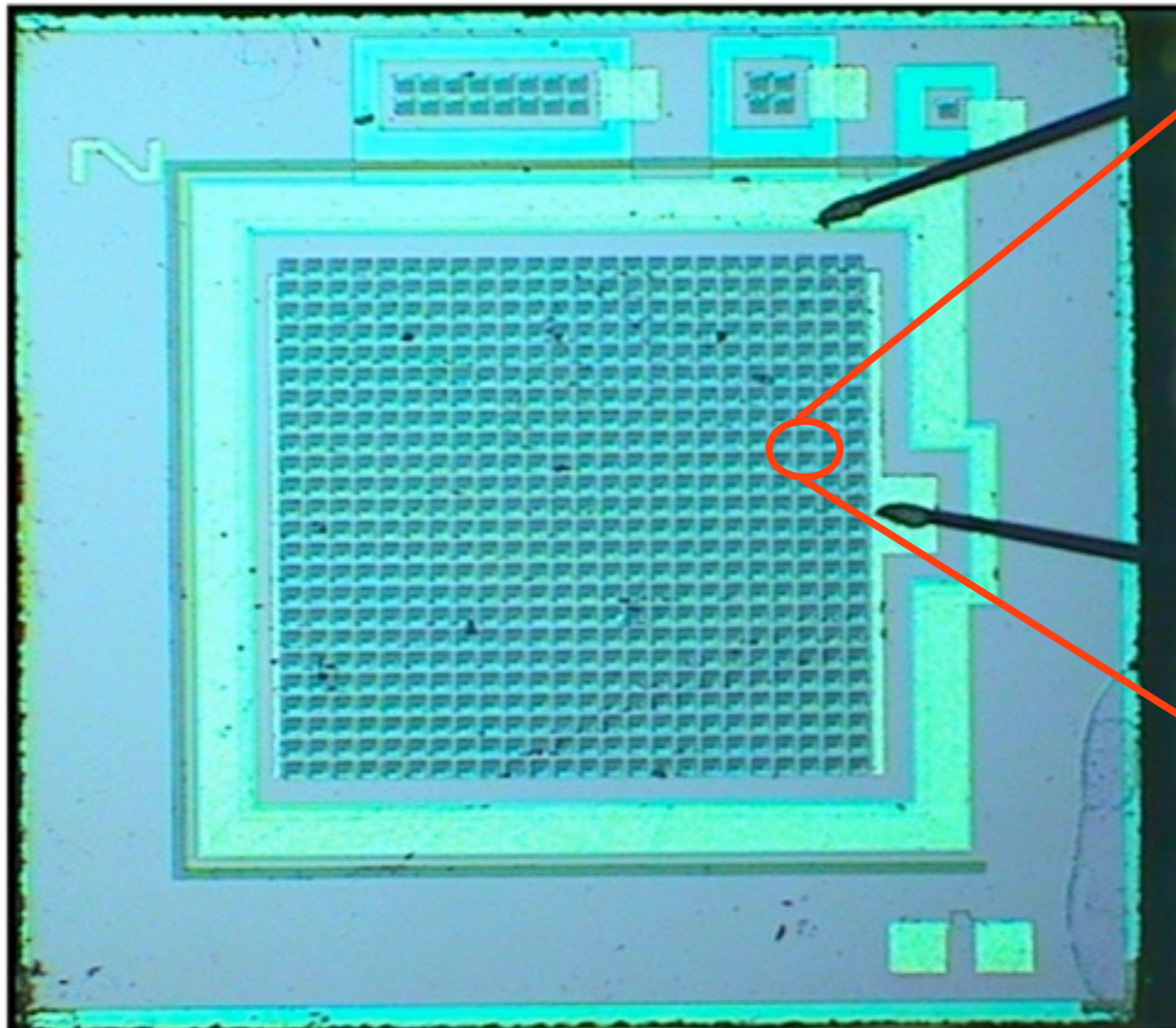

Si* Resistor

Al - conductor

SiPM Signals

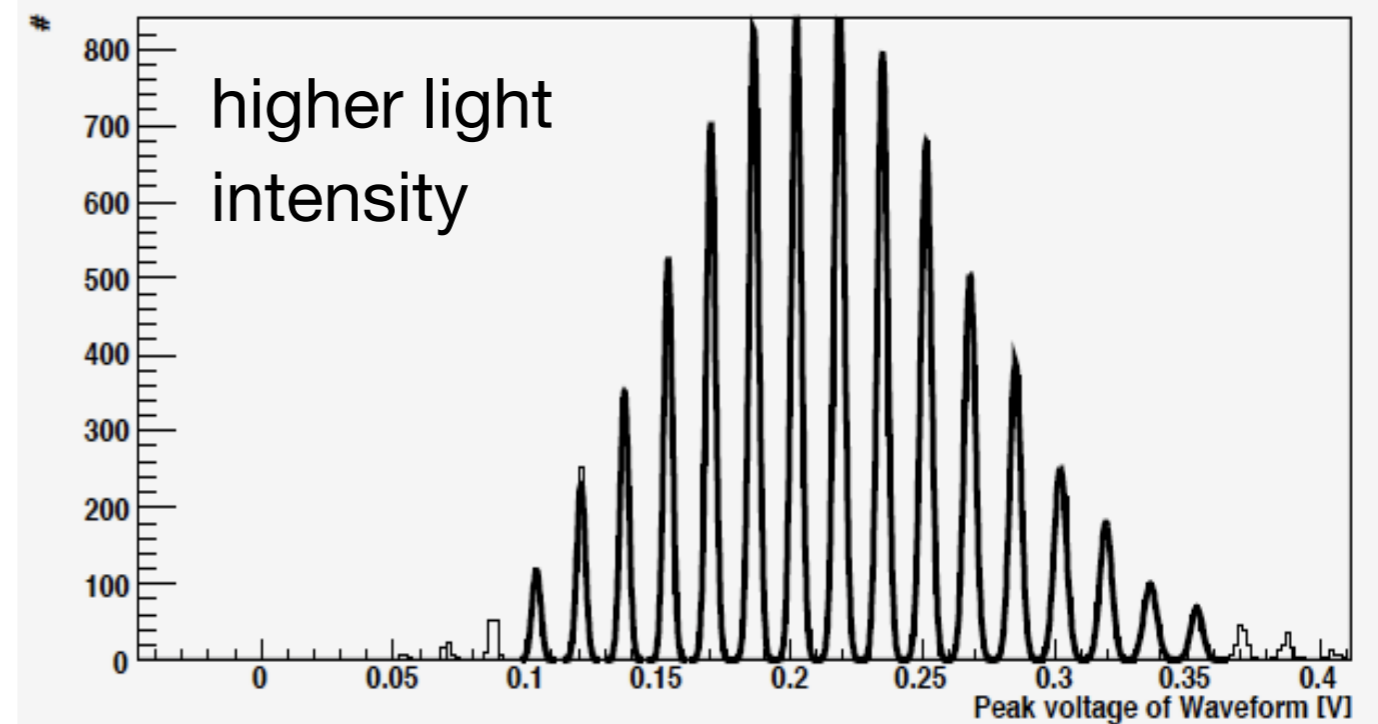
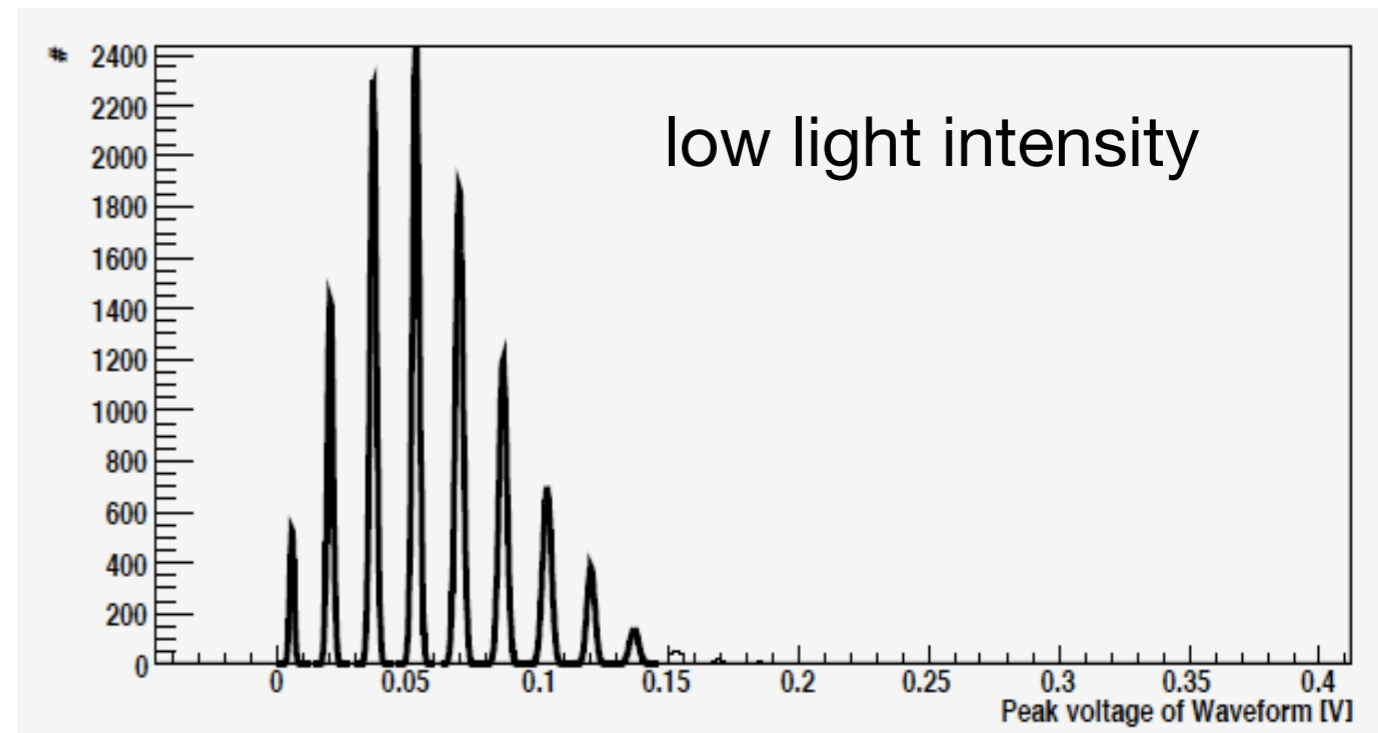
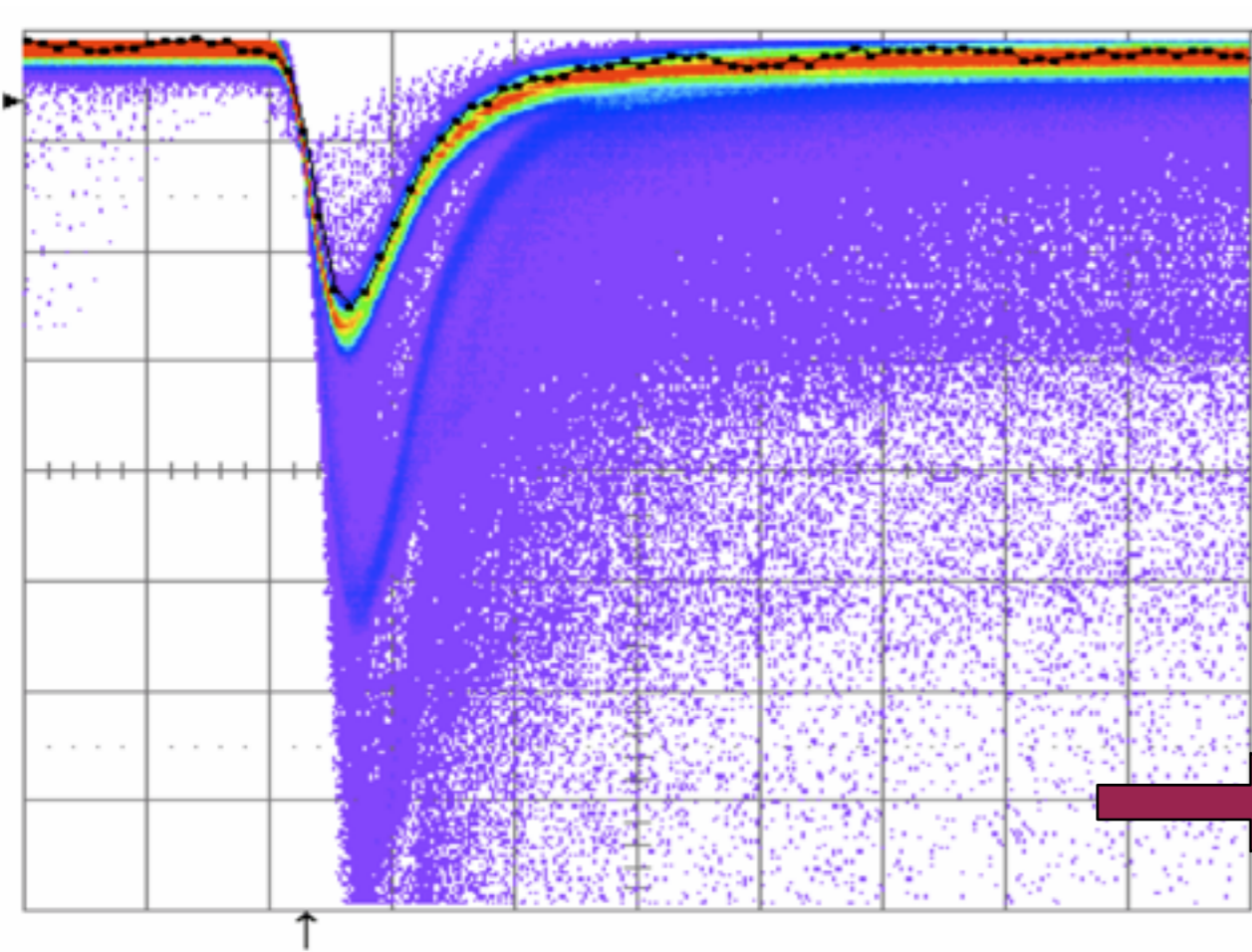

Single photons can be resolved

Experimental Applications

A Few Examples

Cryogenic Detectors: CRESST

- Cryogenic Rare Event Search with Superconducting Thermometers
- Search for weakly interacting massive particles (WIMPs)
- Detection via nuclear recoil in crystals, measured with superconducting thermometers
 - Recoil energy is transformed to phonons, increases temperature of thermometer, change of resistance is detected with SQUIDS

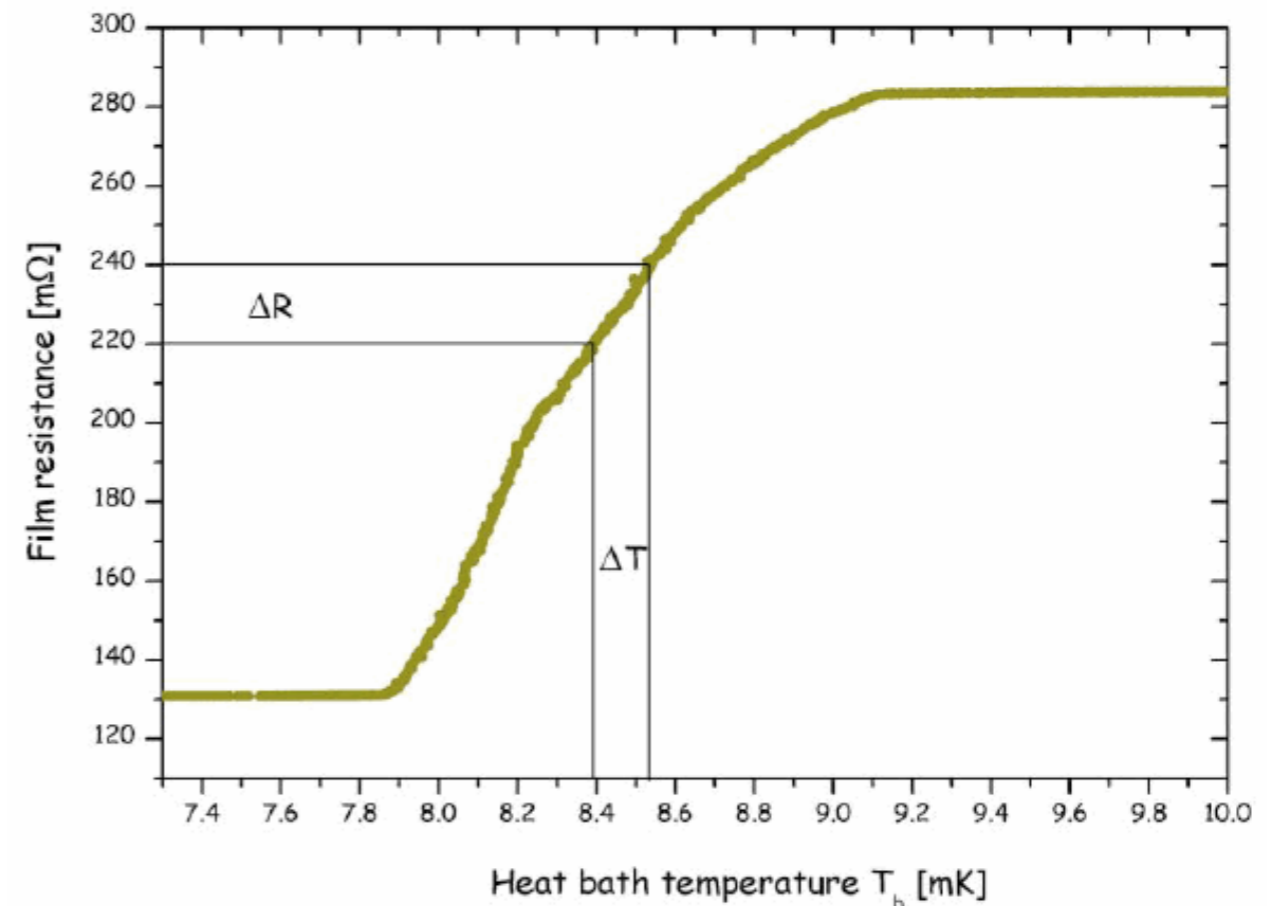
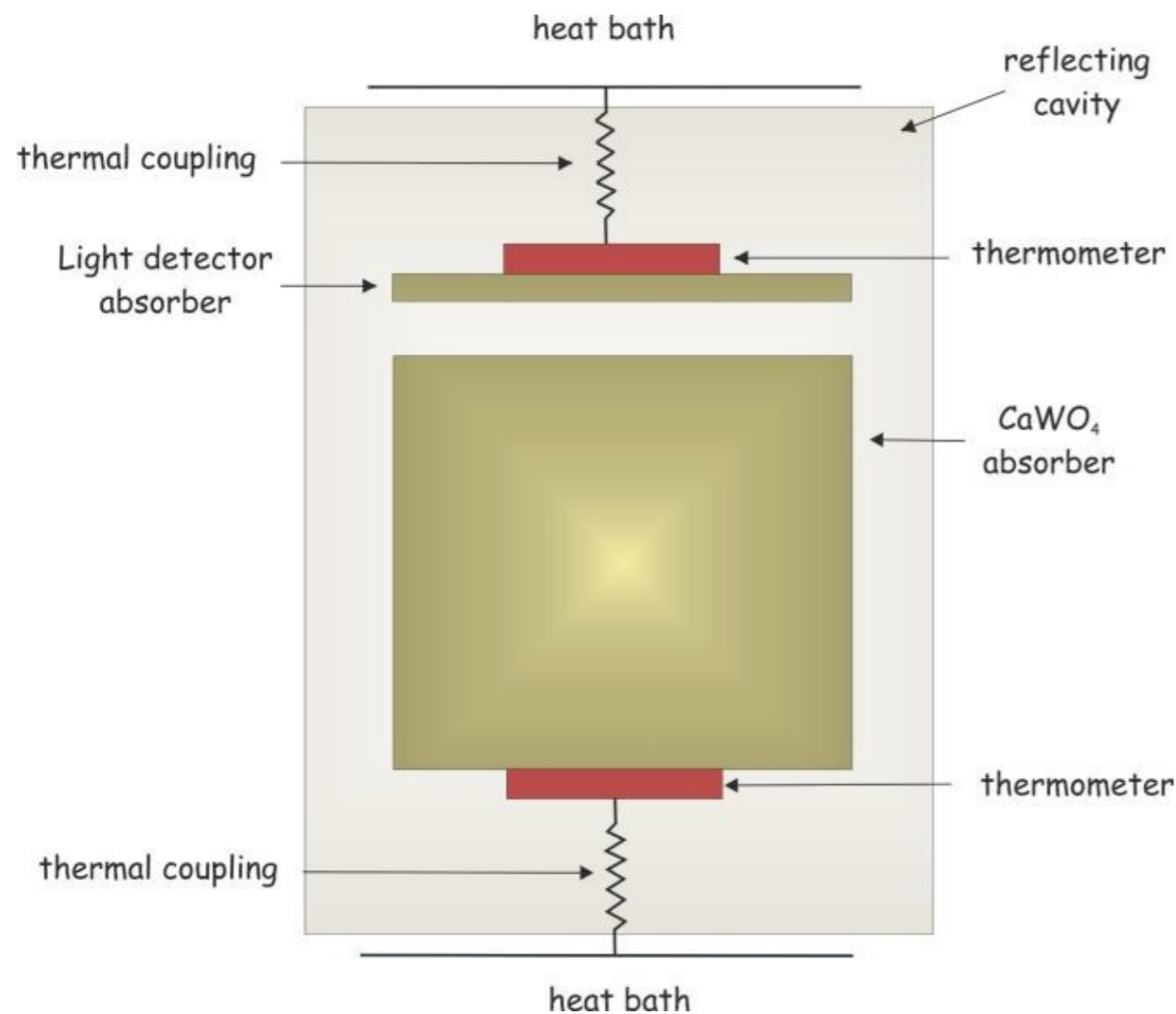

Cherenkov Detectors

- Detection of Cherenkov light: Possibility to measure particle velocity, well suited for particle detection since the light is focused and emitted instantaneously

Cherenkov angle: $\cos\theta_c = \frac{1}{n\beta}$

Cherenkov threshold: $\beta > c/n$

Cherenkov Detectors

- Detection of Cherenkov light: Possibility to measure particle velocity, well suited for particle detection since the light is focused and emitted instantaneously

Cherenkov angle: $\cos\theta_c = \frac{1}{n\beta}$

Cherenkov threshold: $\beta > c/n$

- The simplest detector: Threshold counter - only detected light to give lower limit on velocity

Cherenkov Detectors

- Detection of Cherenkov light: Possibility to measure particle velocity, well suited for particle detection since the light is focused and emitted instantaneously

Cherenkov angle: $\cos\theta_c = \frac{1}{n\beta}$

Cherenkov threshold: $\beta > c/n$

- The simplest detector: Threshold counter - only detected light to give lower limit on velocity
- Velocity measurement: Determination of Cherenkov angle by measurement of parameters of a ring

Ring Imaging Cherenkov Counter

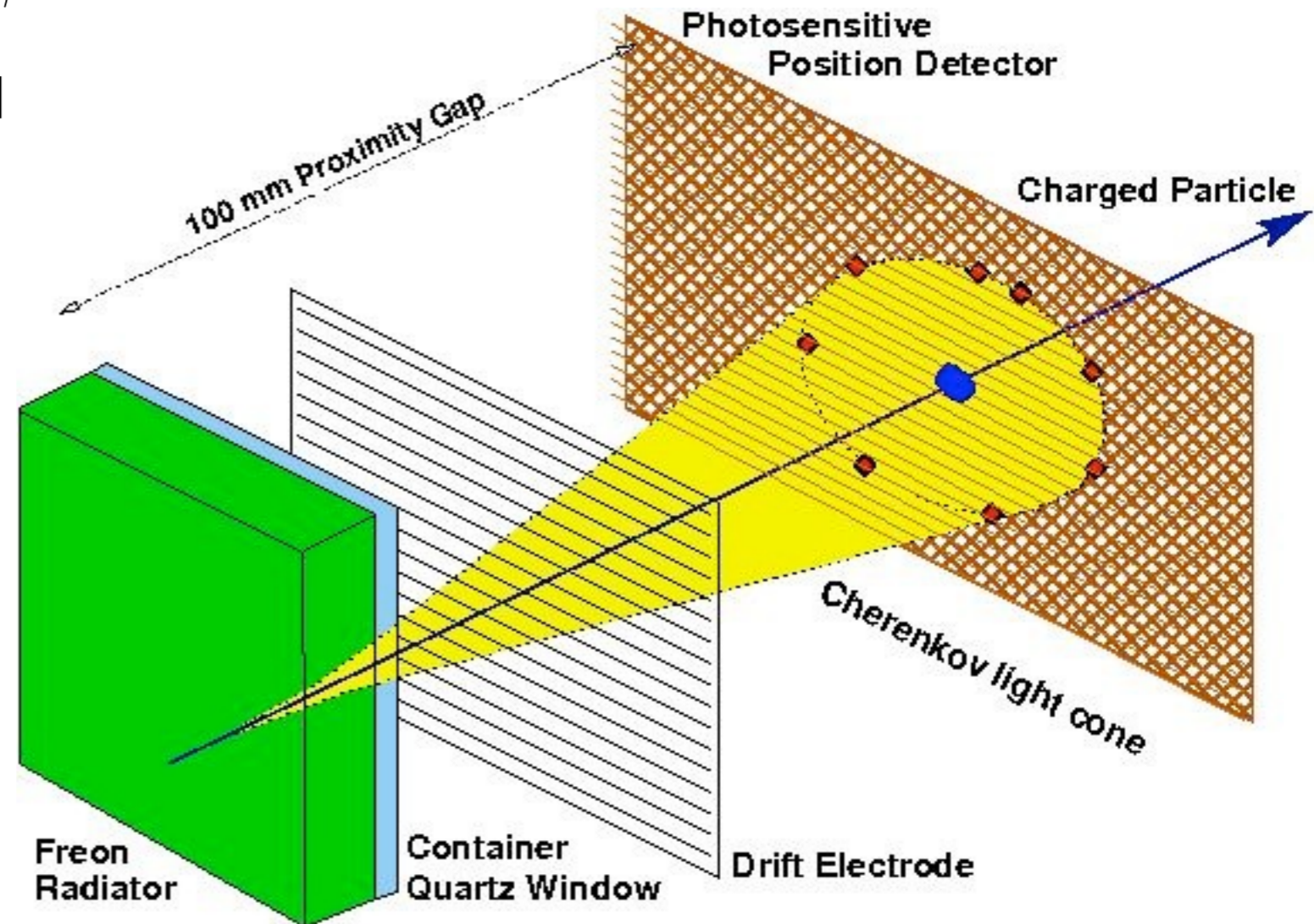

Cherenkov Detectors for Neutrinos

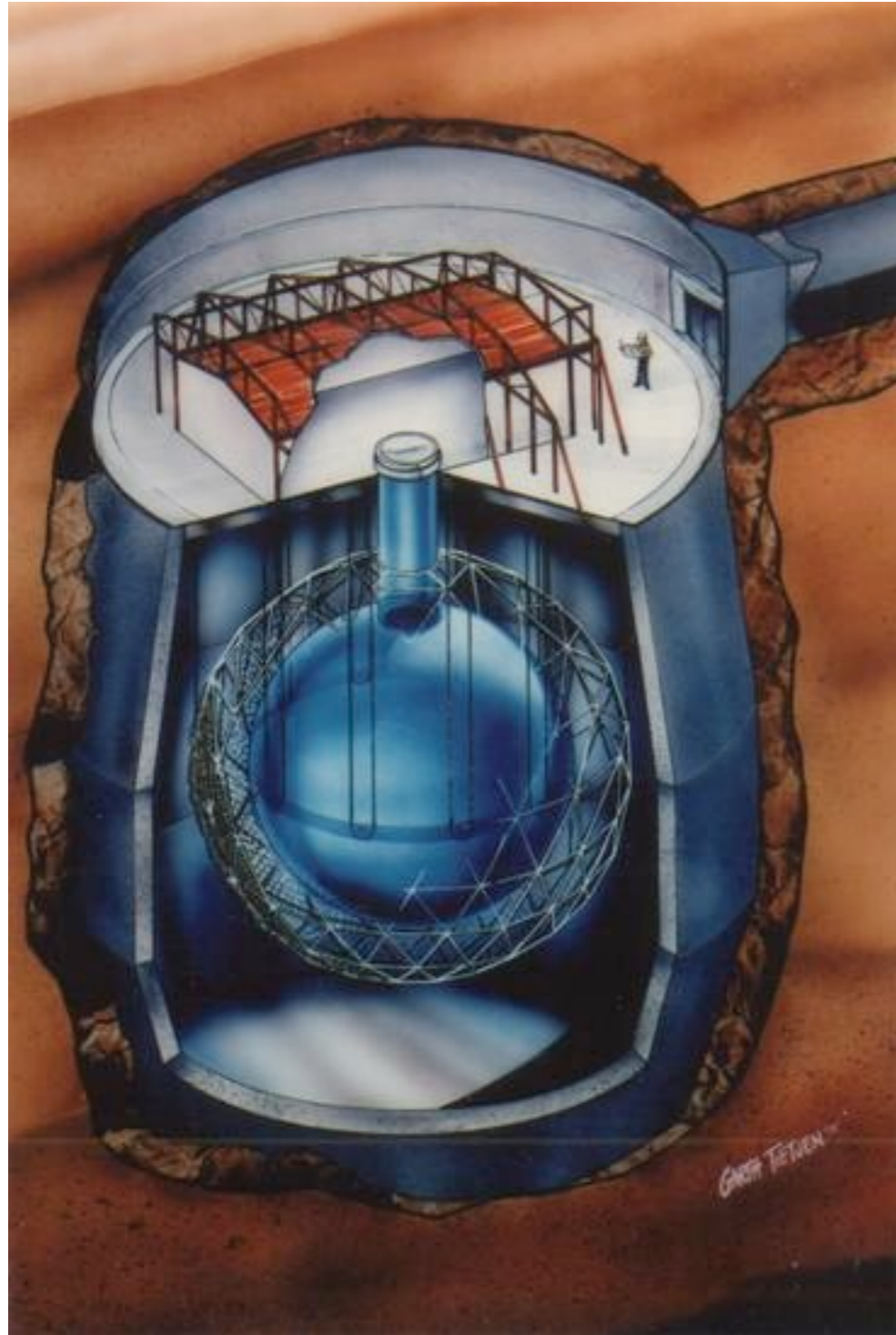

- Detection of electrons and muons created by charged current neutrino reactions:
Emission of Cherenkov light in water, energy measurement by measurement of Cherenkov angle

Cherenkov Detectors for Neutrinos

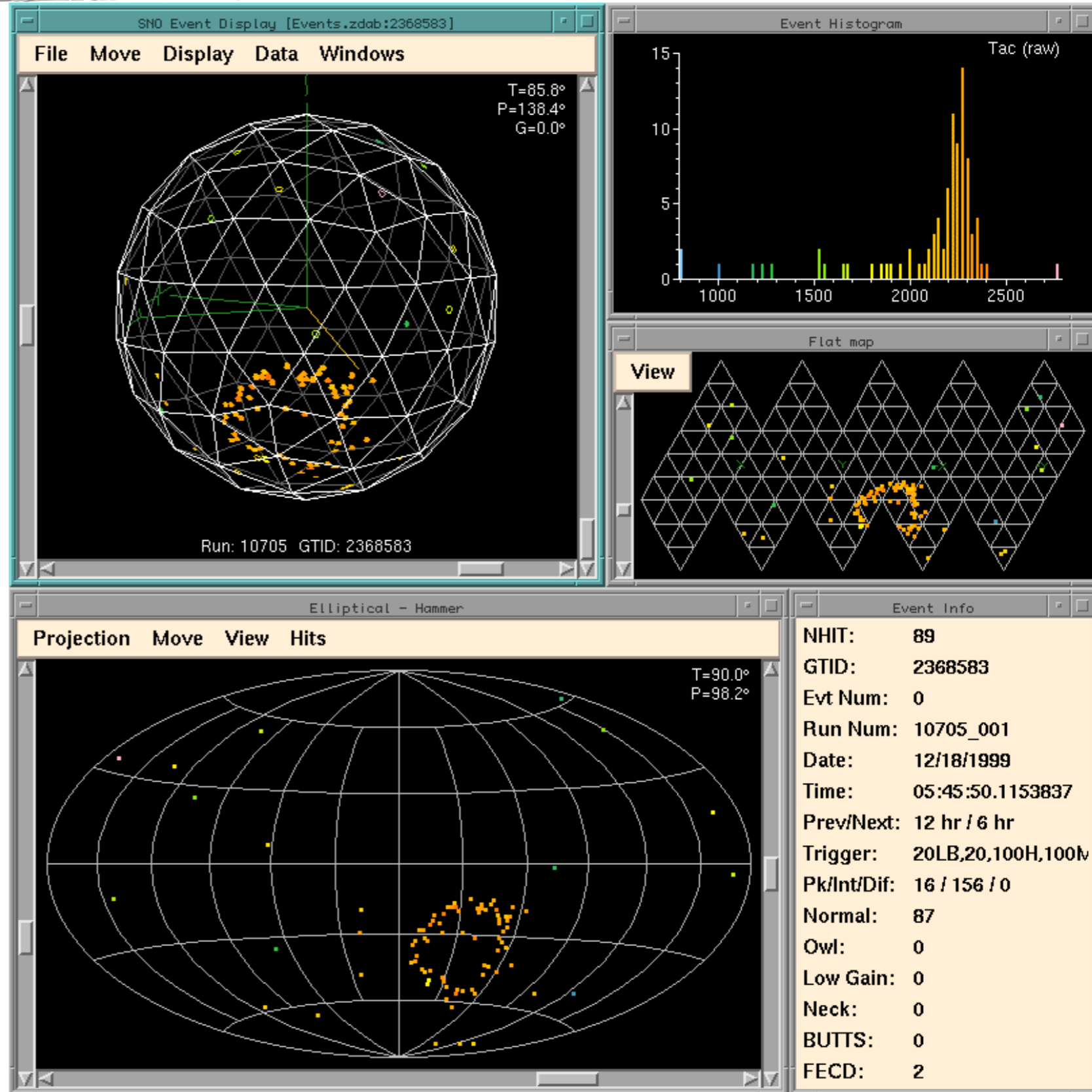
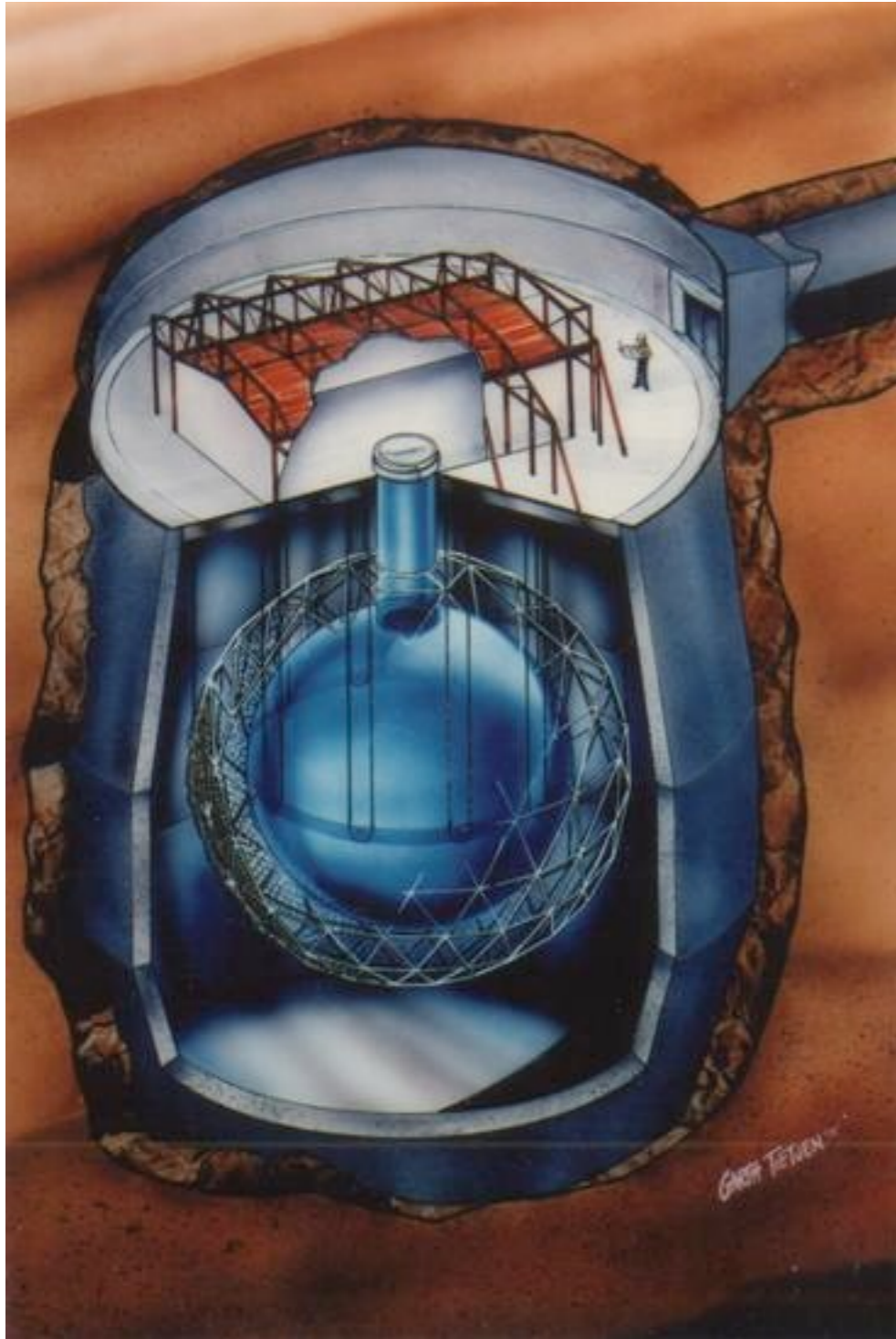

Extremely Large Time Projection Chambers

Anode planes Cathode planes

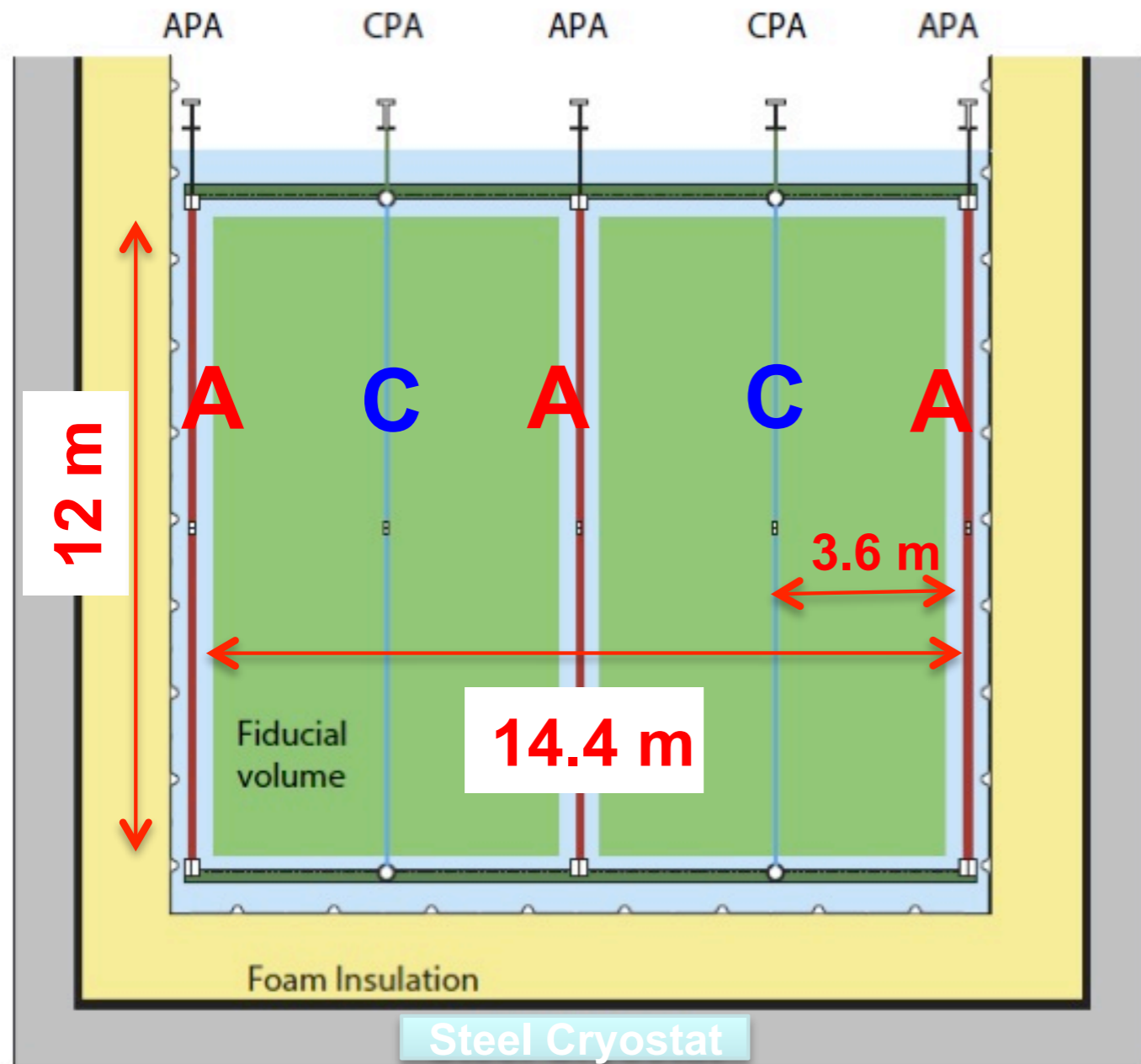

- TPCs: A technique to get 3D Images with 2D readout + time, with large volume detectors
- Commonly used in large gas-filled volumes
- For neutrino experiments: liquid noble gases: liquid argon

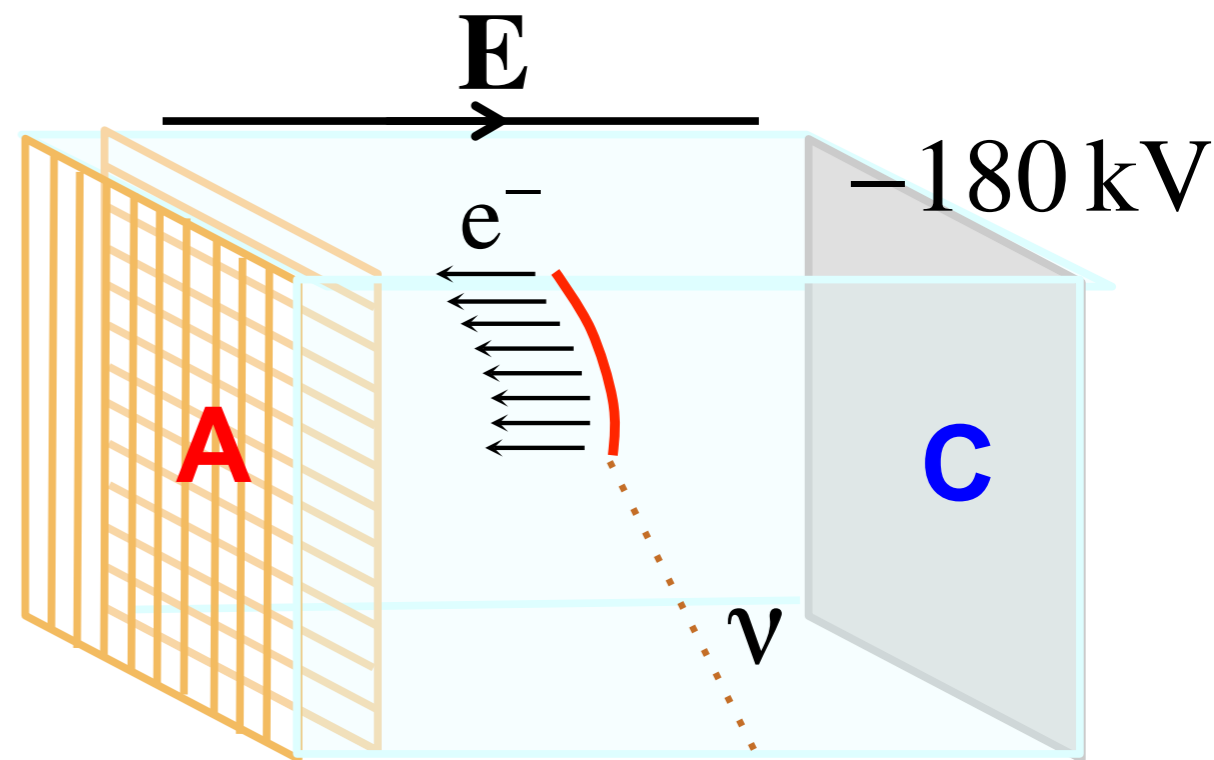

Extremely Large Time Projection Chambers

Anode planes Cathode planes

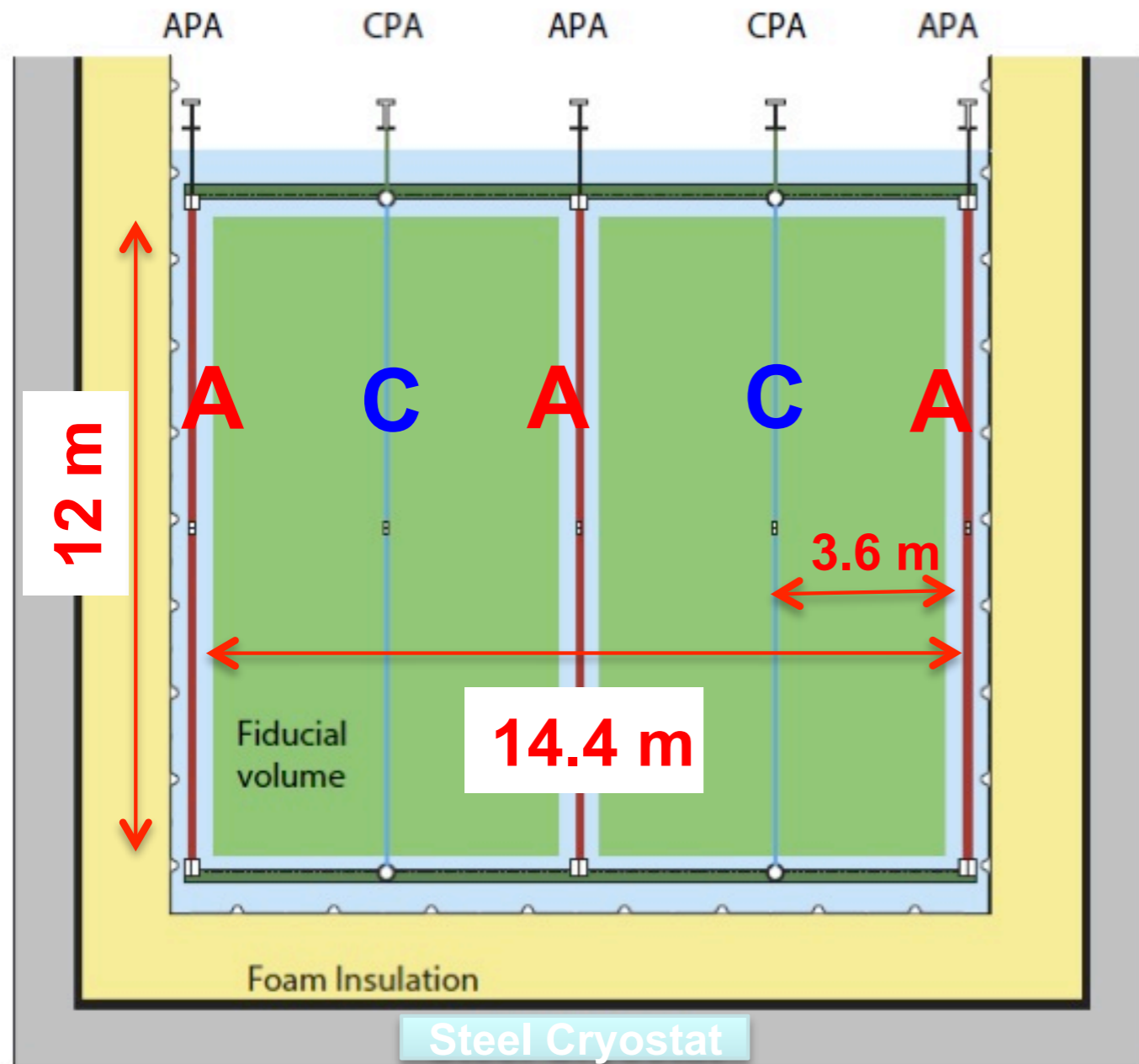

- TPCs: A technique to get 3D Images with 2D readout + time, with large volume detectors
- Commonly used in large gas-filled volumes
- For neutrino experiments: liquid noble gases: liquid argon

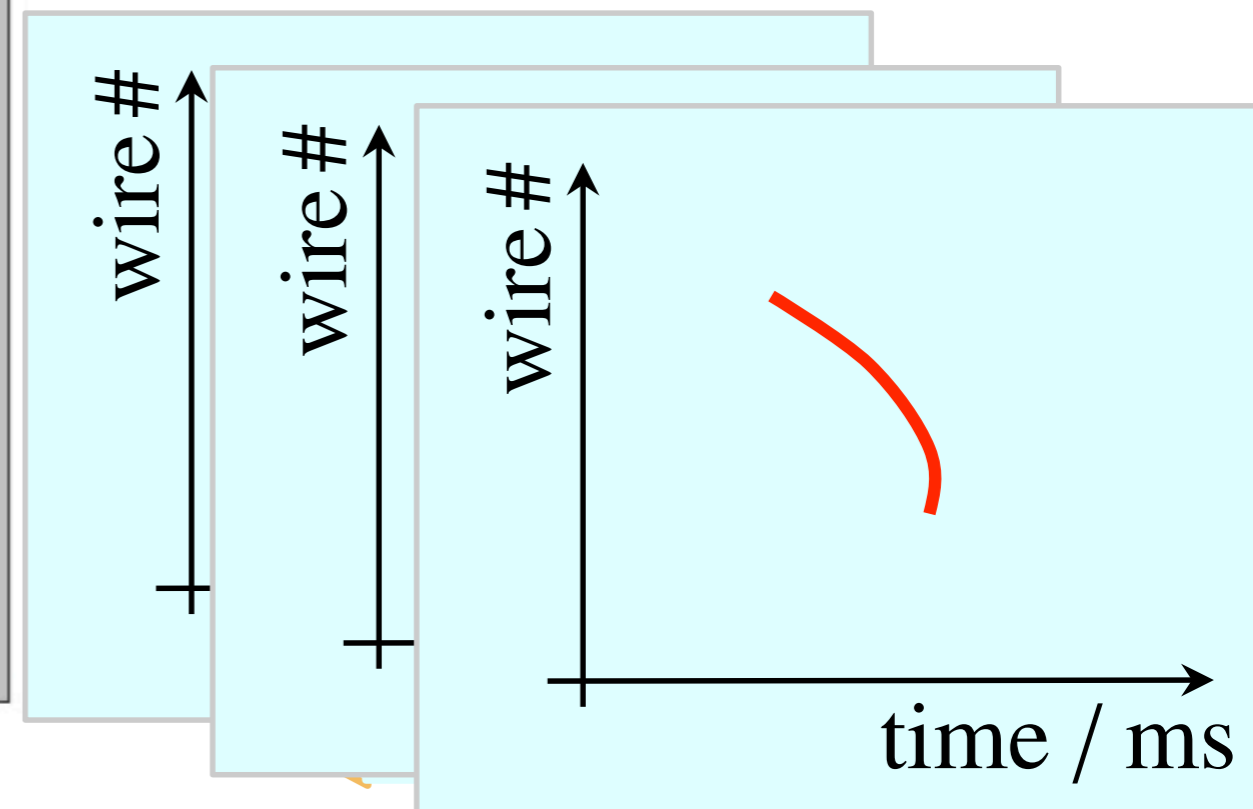

Extremely Large Time Projection Chambers

- For DUNE (Deep Underground Experiment), under construction at Fermilab, USA: 4 Las TPCs, each with 10 kT fiducial volume (17 kT total volume)

Each detector:
60 m long, 14 m wide,
12 m high

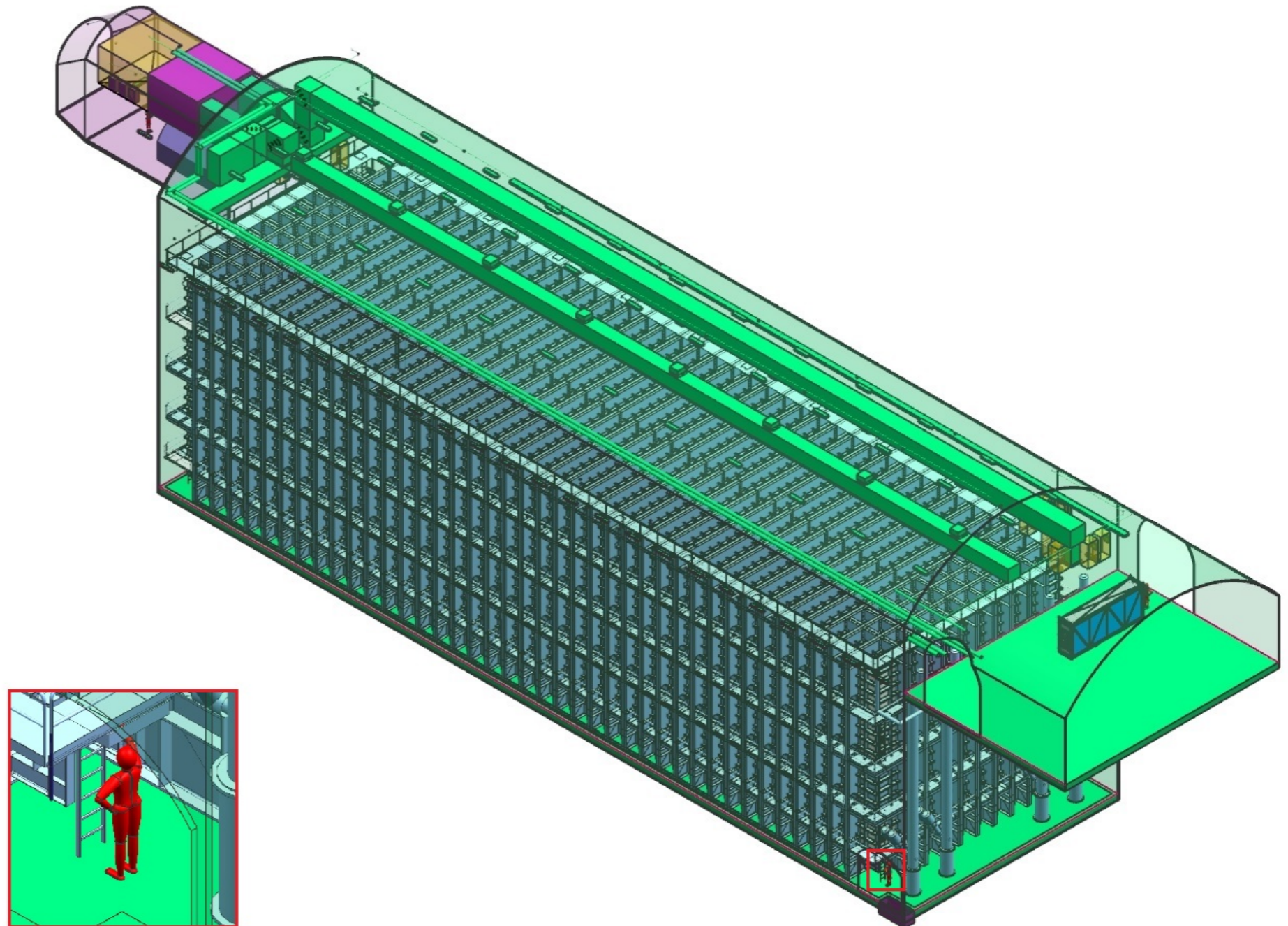

Extremely Large Time Projection Chambers

- For DUNE (Deep Underground Experiment), under construction at Fermilab, USA: 4 LAr TPCs, each with 10 kT fiducial volume (17 kT total volume)

Each detector:
60 m long, 14 m wide,
12 m high

Events from a smaller
(170 t) LAr TPC:
Demonstrates spatial
resolution, pattern
recognition capabilities

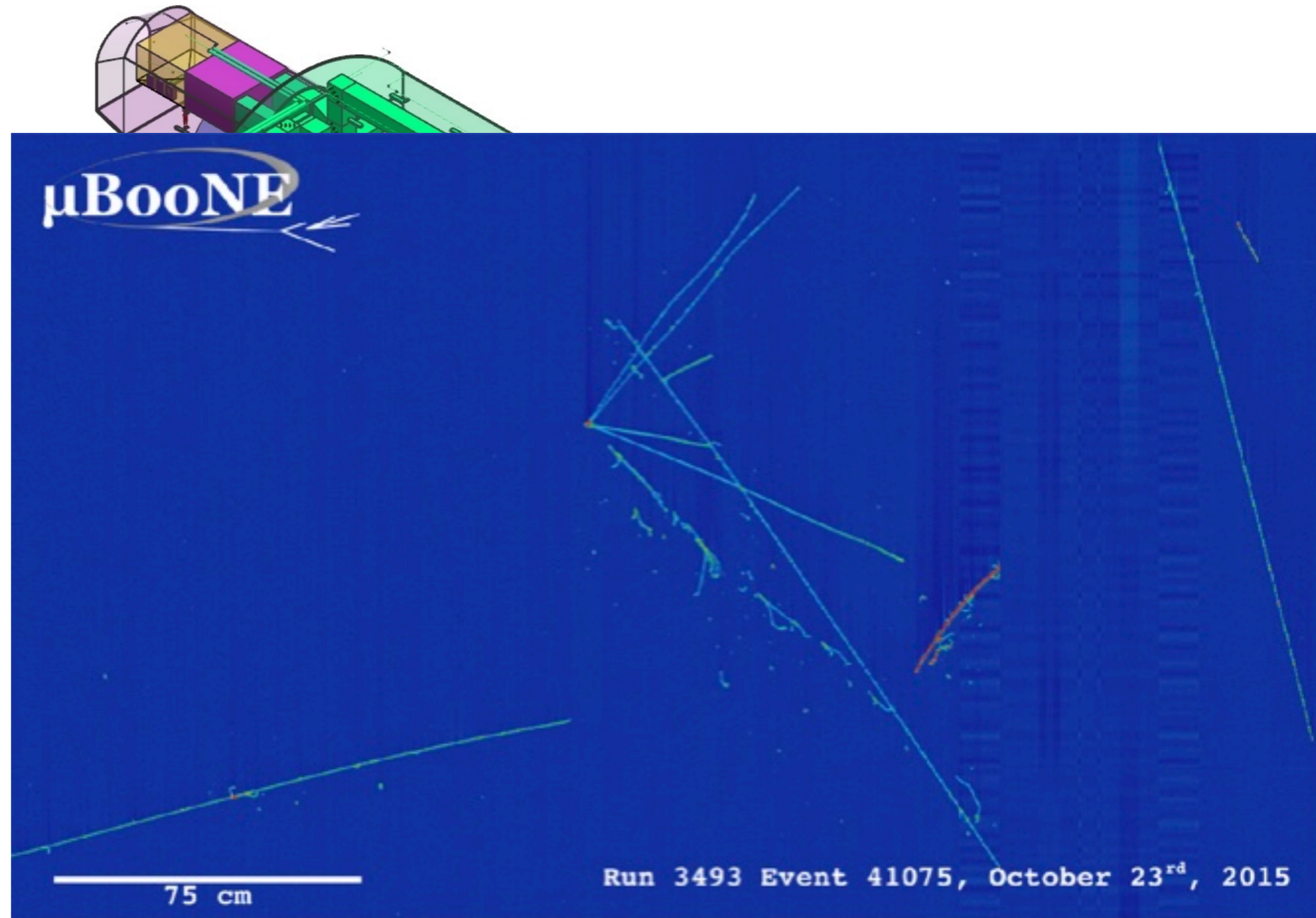

Extremely Large Time Projection Chambers

- Interesting challenge: contain 10 000 m³ of liquid Argon (87 K, -186 C)
 - Technologies from LNG ships



Cherenkov Telescopes for Air Showers

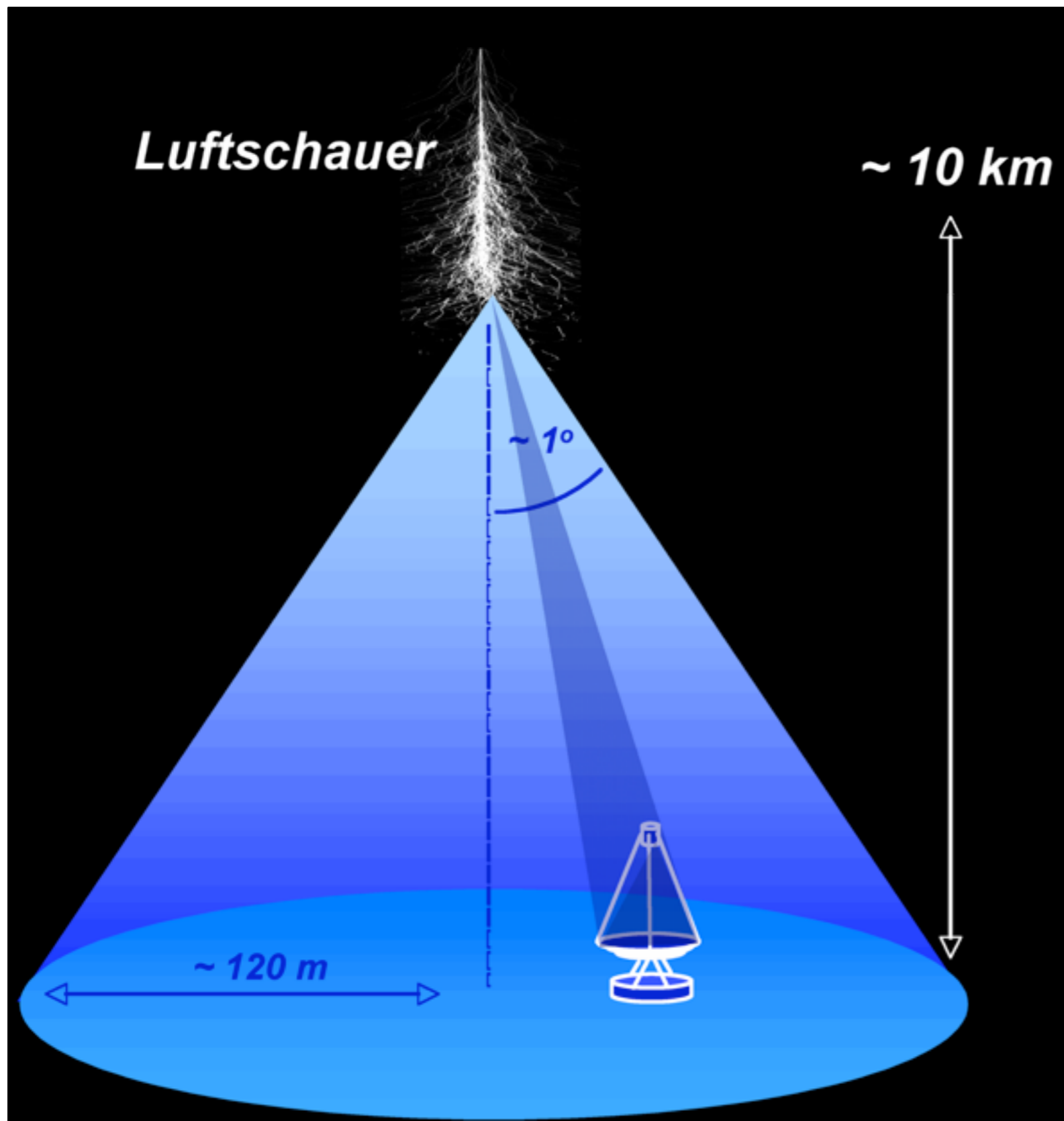

- Cherenkov light is created by electrons in the shower at an altitude of $\sim 10 \text{ km}$
- ▶ On the ground the light spreads over an area with a radius of $\sim 120 \text{ m}$
- ▶ Detection possible with a telescope within this area

Giant Air Shower Arrays

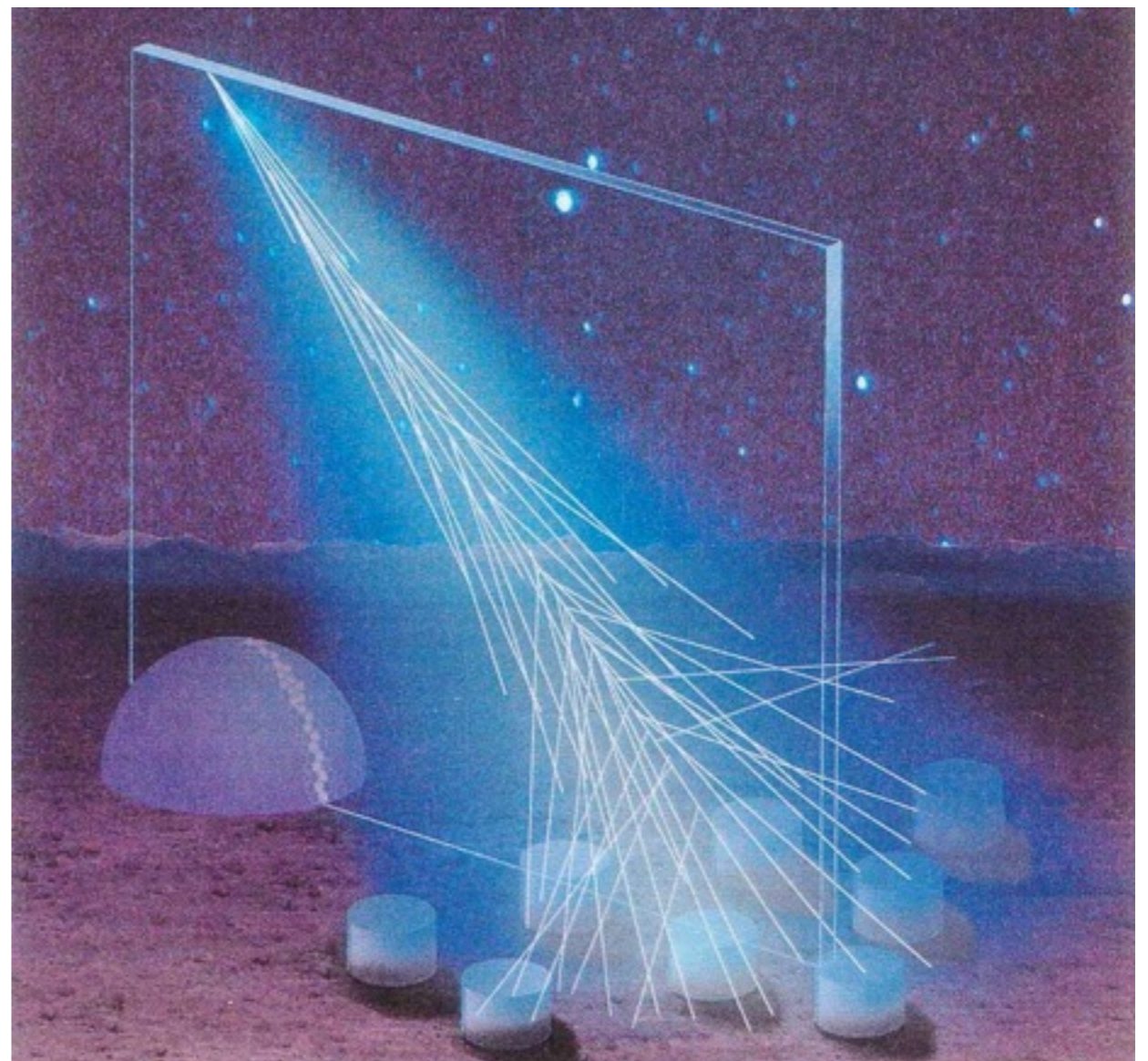
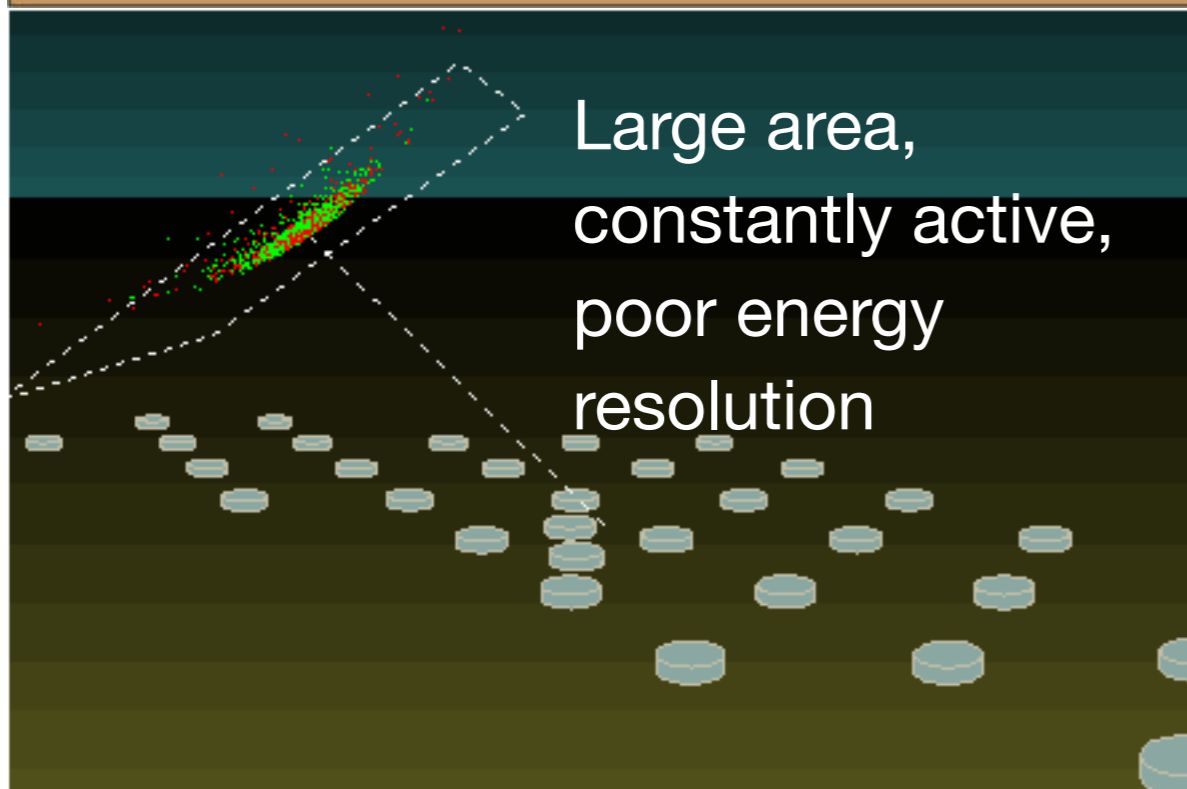
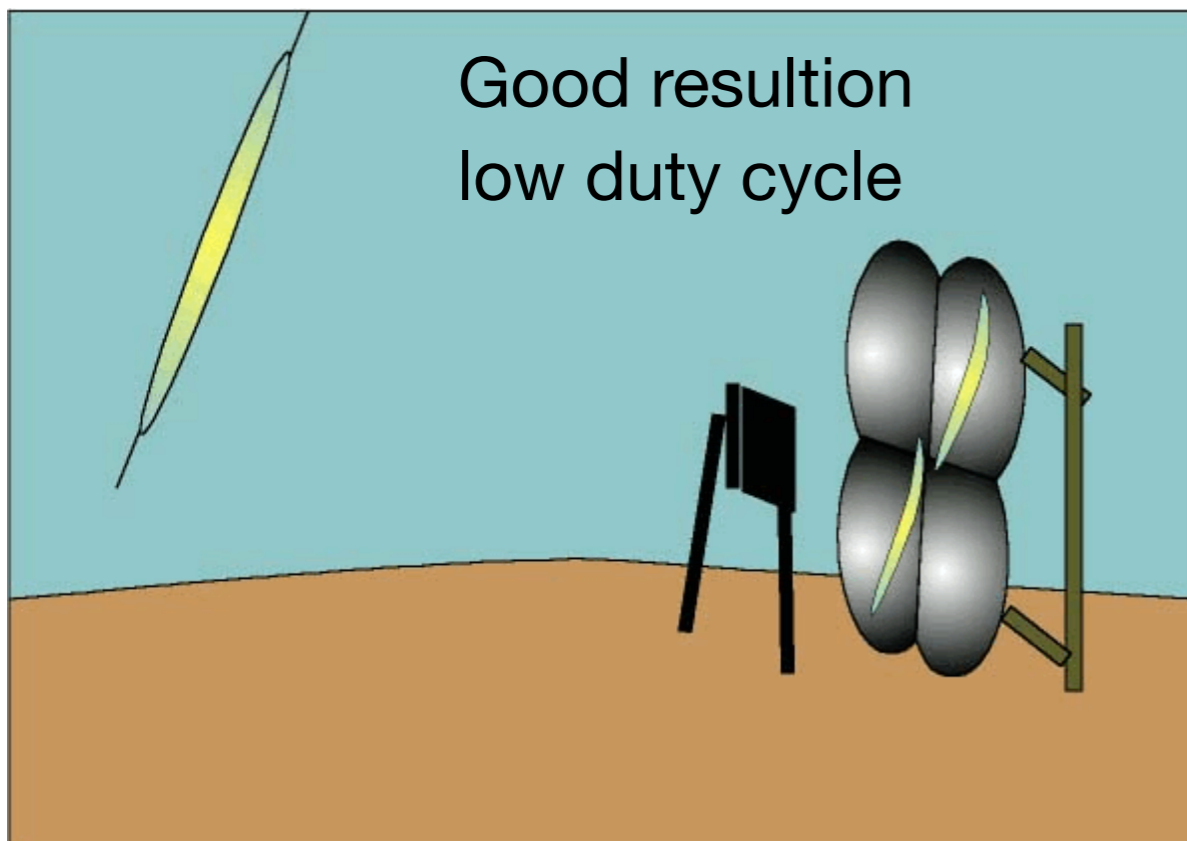

- Two methods for energy measurement
 - Particle multiplicity on the ground
 - Fluorescence light in the atmosphere

Summary

- Differing requirements for detectors in accelerator-based particle physics and astroparticle physics:
 - Extreme rates vs rare events
- Common basis: Interaction of particles with matter
 - Ionization energy loss: Bethe-Bloch
 - Photons: pair production at high energies ($>$ few MeV)
 - Formation of particle showers for highly energetic hadrons, electrons, photons
- Detection techniques
 - Charge collection in gaseous and semi-conductor detectors
 - Light detection, for example for fluorescence / scintillation and Cherenkov detectors

Summary

- Differing requirements for detectors in accelerator-based particle physics and astroparticle physics:
 - Extreme rates vs rare events
- Common basis: Interaction of particles with matter
 - Ionization energy loss: Bethe-Bloch
 - Photons: pair production at high energies ($>$ few MeV)
 - Formation of particle showers for highly energetic hadrons, electrons, photons
- Detection techniques
 - Charge collection in gaseous and semi-conductor detectors
 - Light detection, for example for fluorescence / scintillation and Cherenkov detectors

Next Lecture: 22.05.,
“The Standard Model”, S. Bethke

Lecture Overview

24.04.	Introduction & Accelerators
01.05.	Holiday - No Lecture
08.05	Cosmic Accelerators
15.05.	Detectors
22.05.	The Standard Model
29.05.	QCD and Jets
05.06.	Holiday - No Lecture
12.06.	Neutrinos I
19.06.	Neutrinos II
26.06	most likely: No Lecture
03.07.	Cosmic Rays I
10.07.	Cosmic Rays II
17.07.	Precision Experiments
24.07.	Dark Matter, Dark Energy & Gravitational Waves