

Simulation Studies on a Highly Granular Electromagnetic Calorimeter for the DUNE Near Detector

Lorenz Emberger



Max-Planck-Institut für Physik
(Werner-Heisenberg-Institut)

IMPRS EPP Workshop
12.03.2018

DUNE Physics Program



- DUNE is a Long Baseline Neutrino Experiment using a broad-band ν_μ beam produced with an accelerator
- It consists of two different detectors, separated by 1300 km
- It measures the ν_e appearance and ν_μ disappearance in the oscillated ν_μ beam,
 - To determine the neutrino mass hierarchy
 - Effects of CP violation and neutrino mass hierarchy on the oscillation probability disentangle for long baselines
 - To search for CP-violation in differences of the ν_e /anti- ν_e appearance
 - $P(\nu_\mu \rightarrow \nu_e) = P(\bar{\nu}_\mu \rightarrow \bar{\nu}_e)$ if CP is conserved

DUNE Experiment



- Protons from the Fermilab Main Injector are used to generate a broadband ν_μ beam with energies primarily from 0.5 to 5 GeV

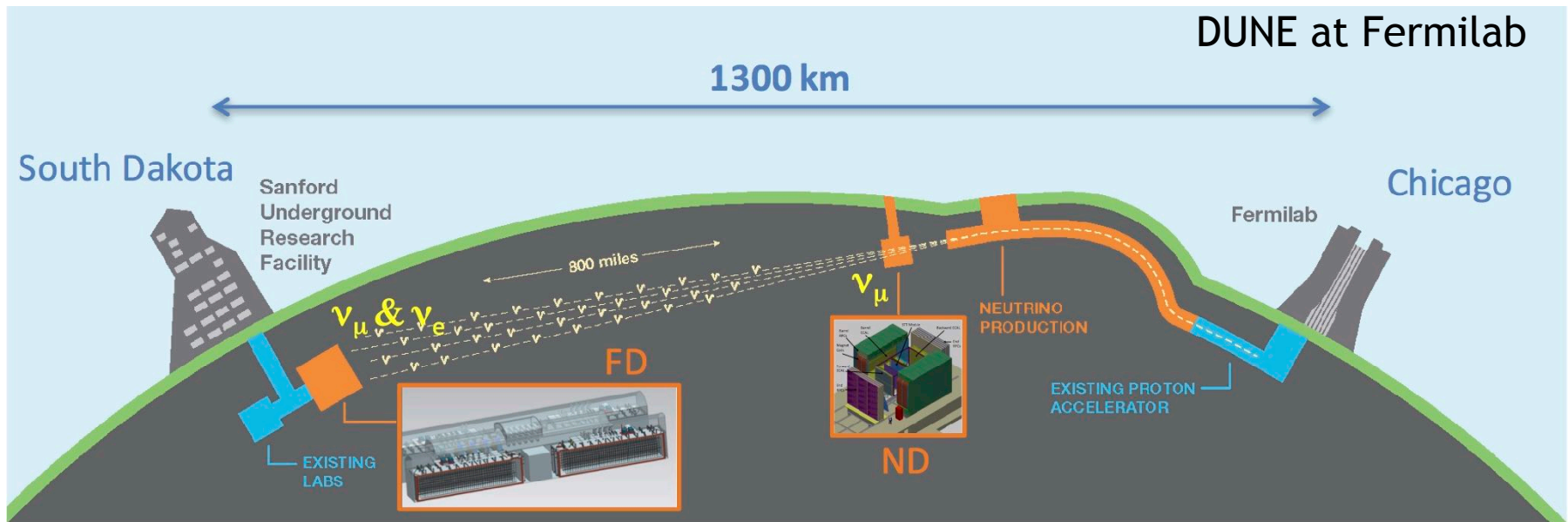

Far Detector: Liquid Argon TPC to measure oscillated spectrum - will see CP violation in ν_e /anti- ν_e appearance

Near Detector: measures beam before oscillation, required to understand initial flux and cross sections to understand FD signal

Near Detector Tasks



- Measure the energy spectrum of the beam, background rates and contamination
 - Provide precise extrapolation of event rates in the far detector
- Largest errors arise from uncertainties in neutrino-nucleon scattering amplitudes
- Important for control of systematics: ν_μ -induced neutral current π^0 production

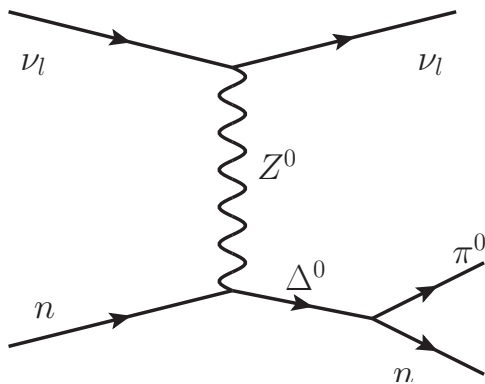

Resonant NC π^0 production

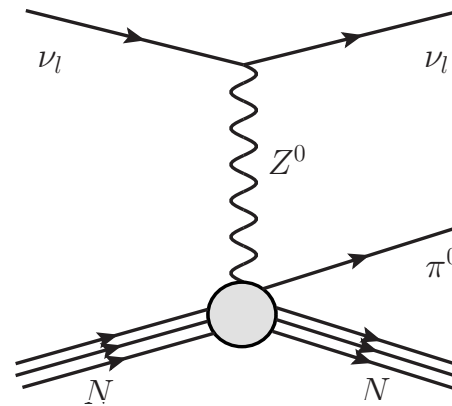

Coherent NC π^0 production

- $\pi^0 \rightarrow \gamma\gamma$ (R=98.8) events can mimic ν_e signals (electrons) in the far detector

Near Detector ECal



Possible layout: High Pressure Gaseous Argon TPC surrounded by an electromagnetic calorimeter and magnet

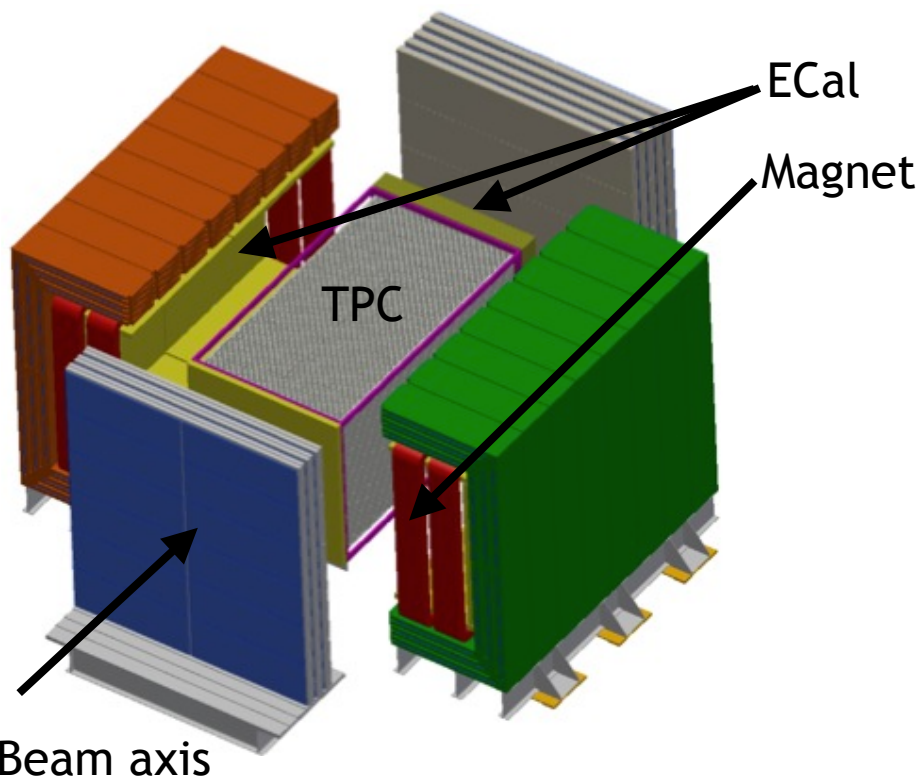

- Conversion probability for photons too low in TPC
→ tracker based π^0 reconstruction not possible
- Our interest: Can high granularity help?
 - Try to reconstruct π^0 decay vertex

The Challenge: Typical π^0 energies $\sim 100\text{MeV}$ → Photon energies $\sim 50\text{MeV}$

Detector Concept



Calorimeter design is inspired by CALICE Highly Granular Calorimeter

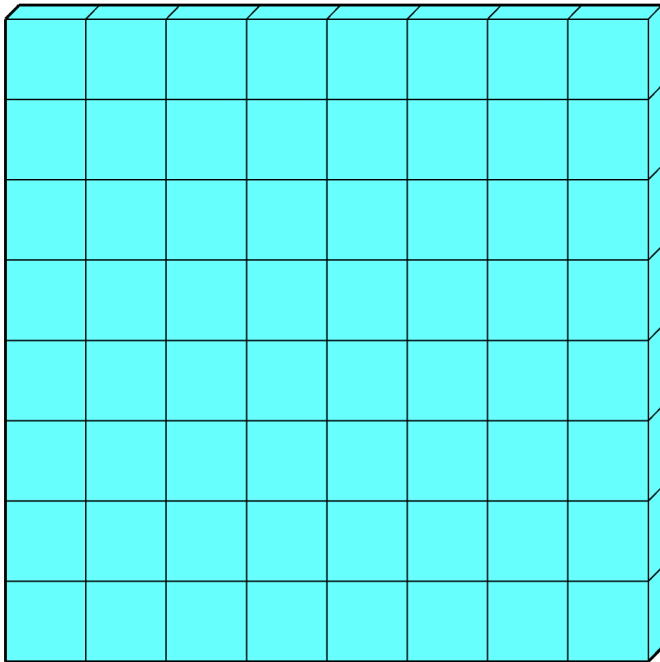

- Sampling calorimeter, active material segmented in 20mm x 20mm tiles (default)

Detector Concept



Calorimeter design is inspired by CALICE Highly Granular Calorimeter

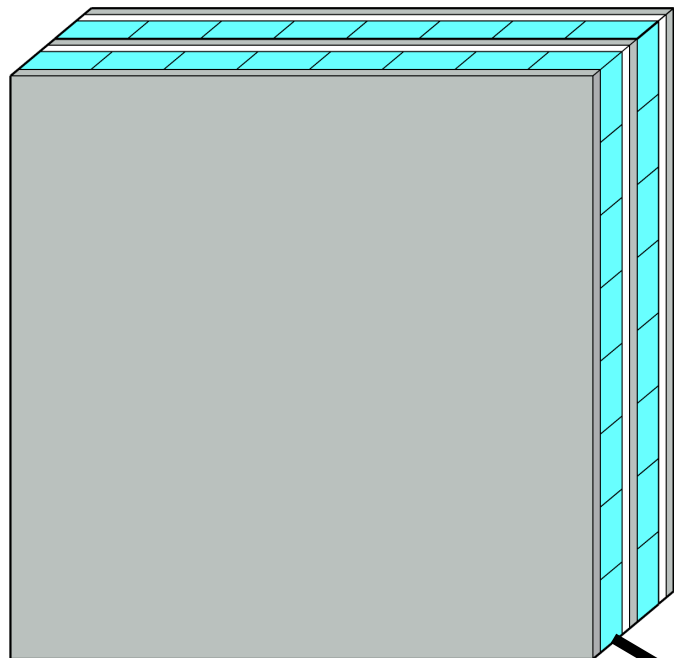

- Sampling calorimeter, active material segmented in 20mm x 20mm tiles (default)
- Default layer structure:
 - 1mm lead absorber
 - 5mm plastic scintillator
 - Gap for electronics
- SiPM readout

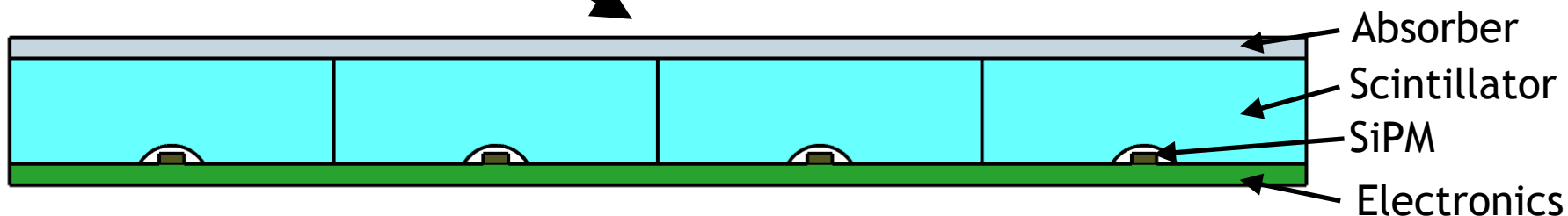

Detector Concept



Look at the scenario of a split ECal to instrument space in the TPC pressure vessel

Possible pressure vessel designs: 20mm Steel ($\sim 1X_0$), 14mm Titan ($\sim 0.4X_0$)

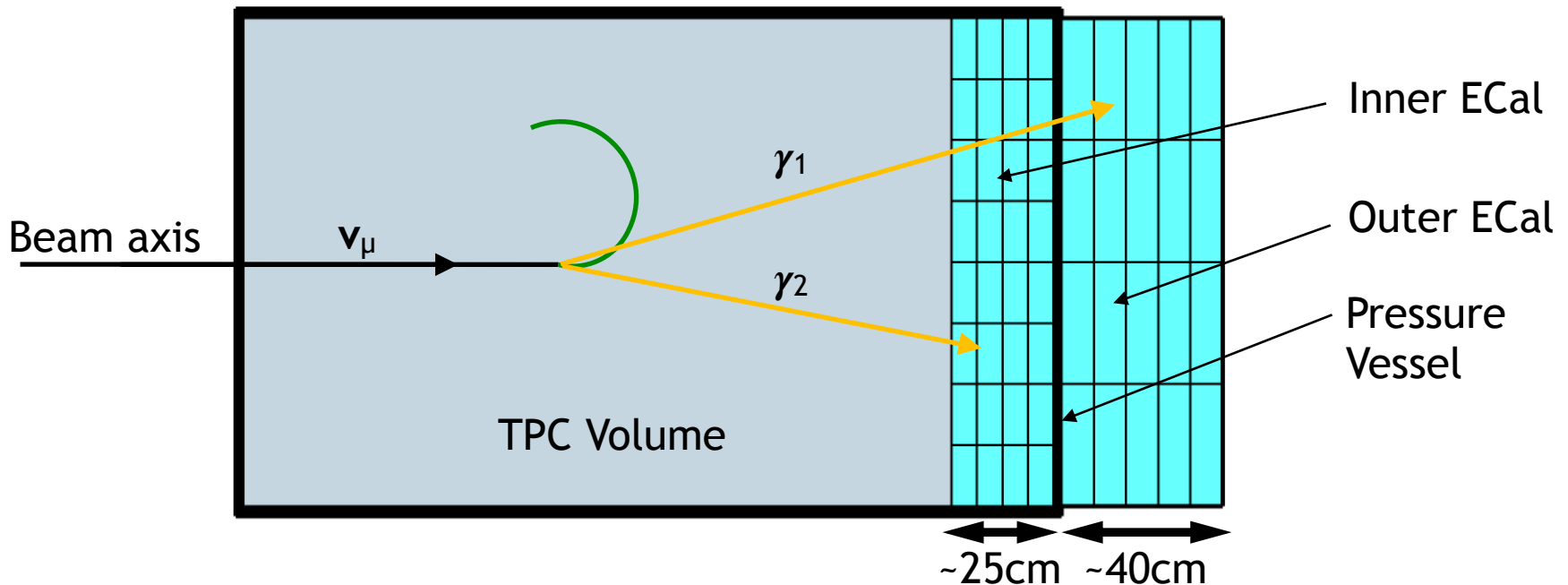

Inner ECal increases the chance to detect low energy photons

Simulation and Reconstruction



- Simulation is implemented in Geant 4.10.3
- Reconstruction:
 1. Apply energy cut and amplitude smearing every channel
 2. Data preprocessing
 3. Calculate energy center of gravity in each layer
 4. Reconstruct direction with straight line fit of all centers of gravity
 5. Calculate angular and energy resolution

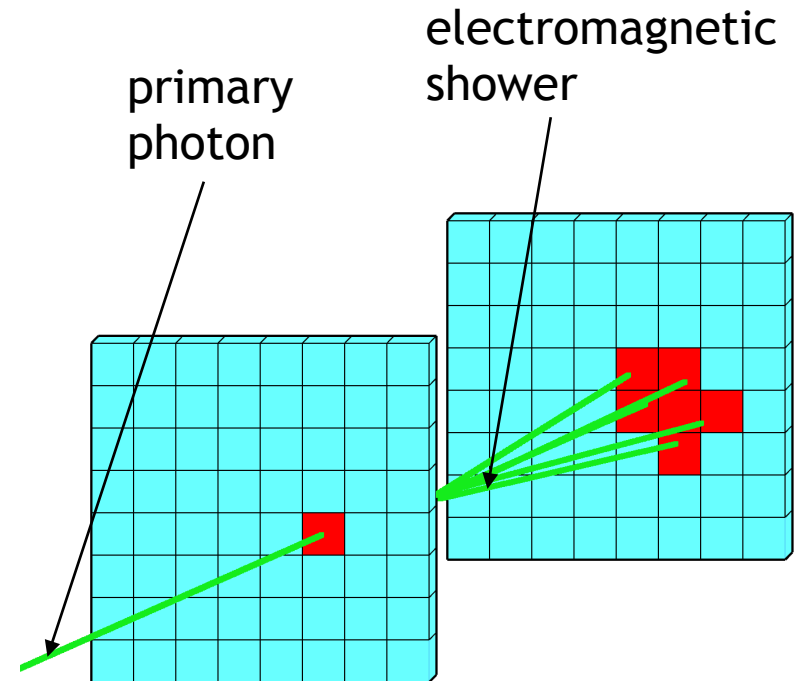

Energy Resolution



Energy resolution is an important parameter to compare different materials

Single photon visible energy: $E_{\text{Beam}}=650\text{MeV}$

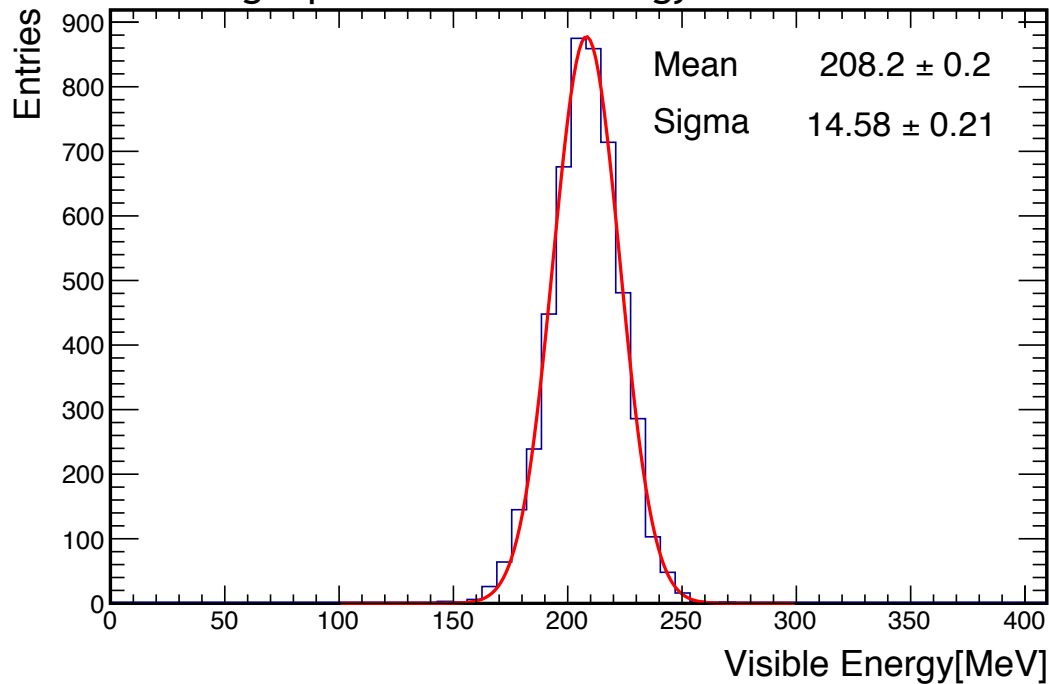

1. Calculate energy sum over all channels per event
2. Plot sigma over mean for different energies

Energy Resolution



Energy resolution is an important parameter to compare different materials

EnergyResolution: Default Geometry

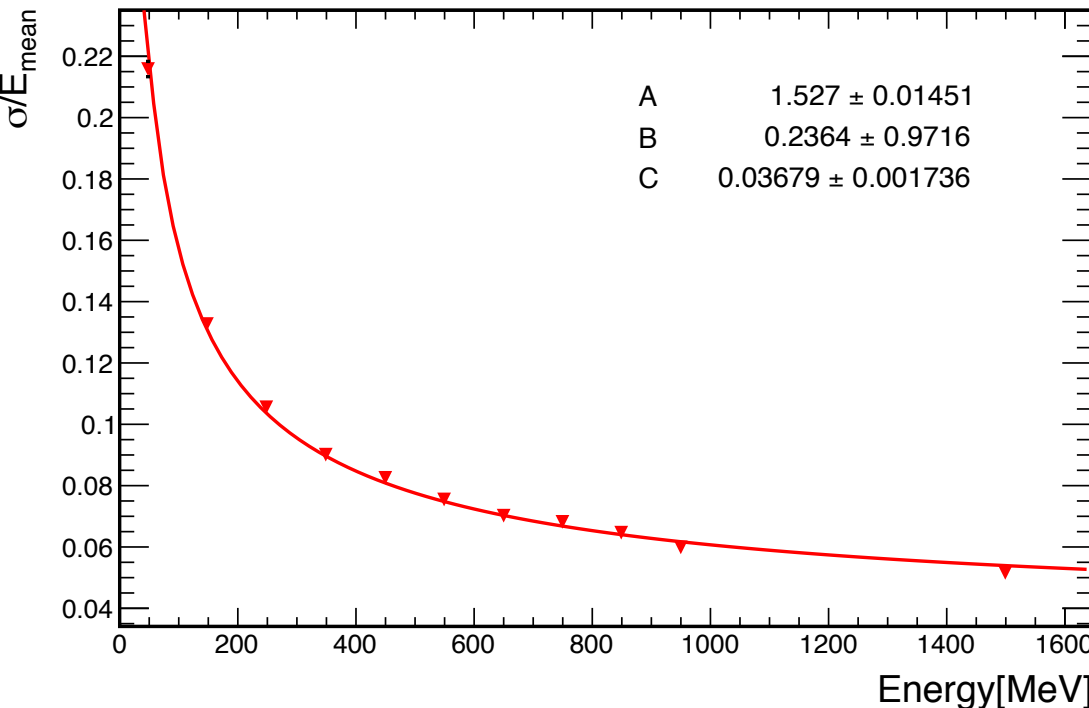

1. Calculate energy sum over all channels per event

2. Plot sigma over mean for different energies

3. Fit with

$$\frac{\sigma}{E_{mean}} = \sqrt{\left(\frac{A}{\sqrt{E[MeV]}}\right)^2 + \left(\frac{B}{E[MeV]}\right)^2 + C^2}$$

$\frac{4.8\%}{\sqrt{E[GeV]}}$ stochastic term, will get worse by simulating more electronics

Angular Resolution



Angular resolution has direct impact on photon pointing

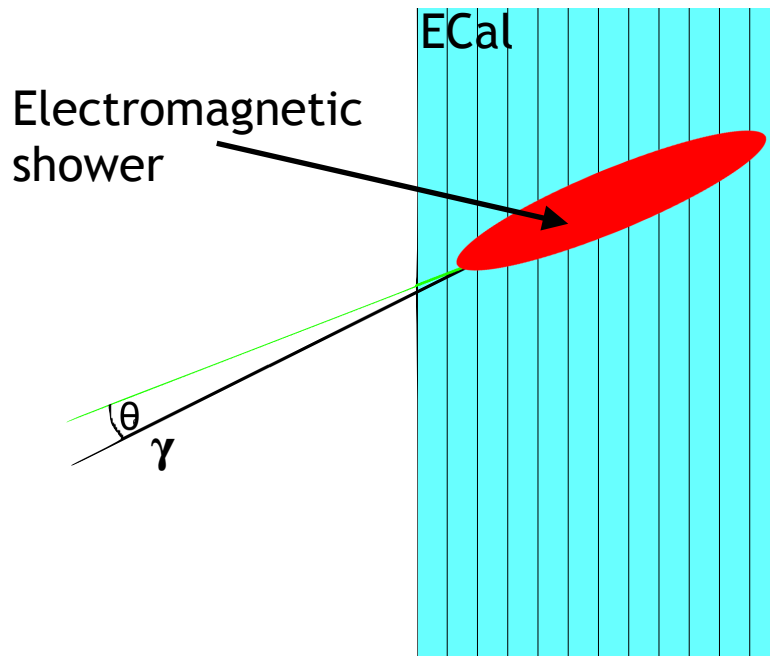

1. Find the distribution of the angle between true and **reconstructed** direction for every energy

Angular Resolution



Angular resolution has direct impact on photon pointing

Single photon angle distribution: $E_{\text{Beam}}=450\text{MeV}$

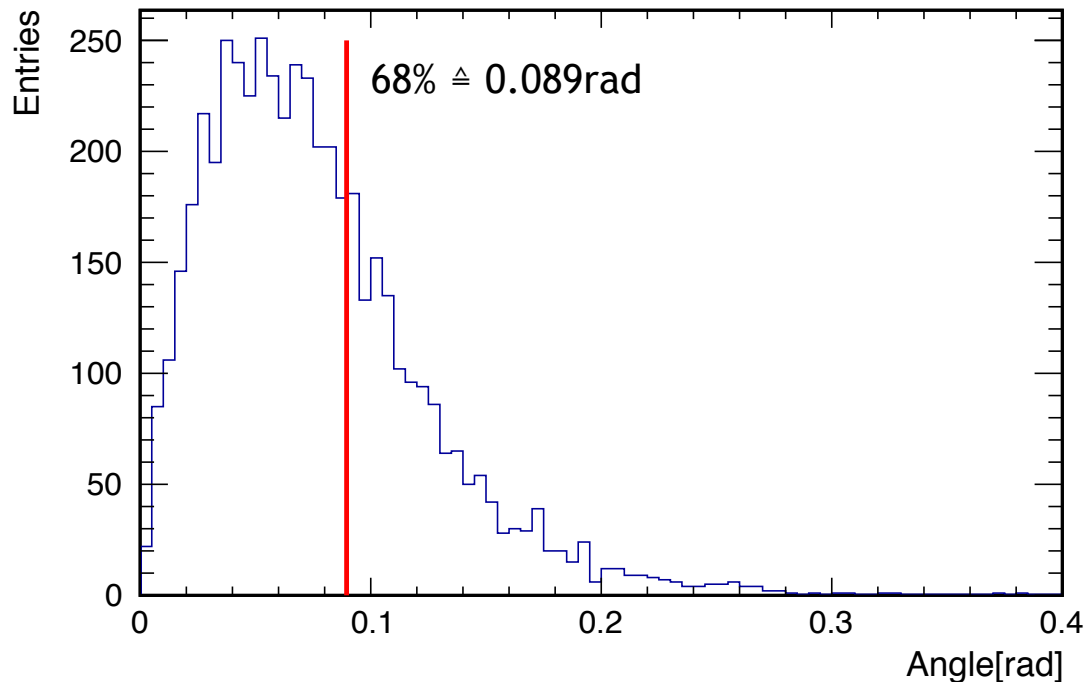

1. Find the distribution of the angle between true and **reconstructed** direction for every energy
2. Plot 68% integral for every energy

Angular Resolution



Angular resolution has direct impact on error of photon direction reconstruction

Angular resolution: Default geometry

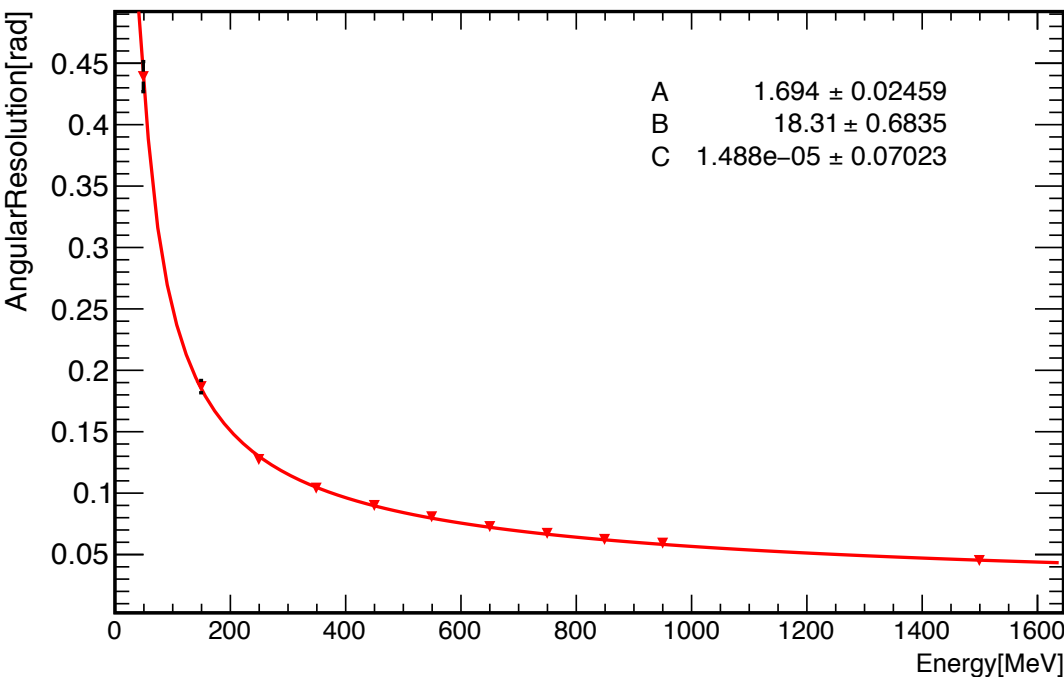

1. Find the distribution of the angle between true and **reconstructed** direction for every energy
2. Plot 68% integral for every energy
3. Fit with

$$Resolution = \sqrt{\left(\frac{A}{\sqrt{E[MeV]}}\right)^2 + \left(\frac{B}{E[MeV]}\right)^2 + C^2}$$

Both resolutions are used to evaluate the performance of the calorimeter

Study of Detector Parameters

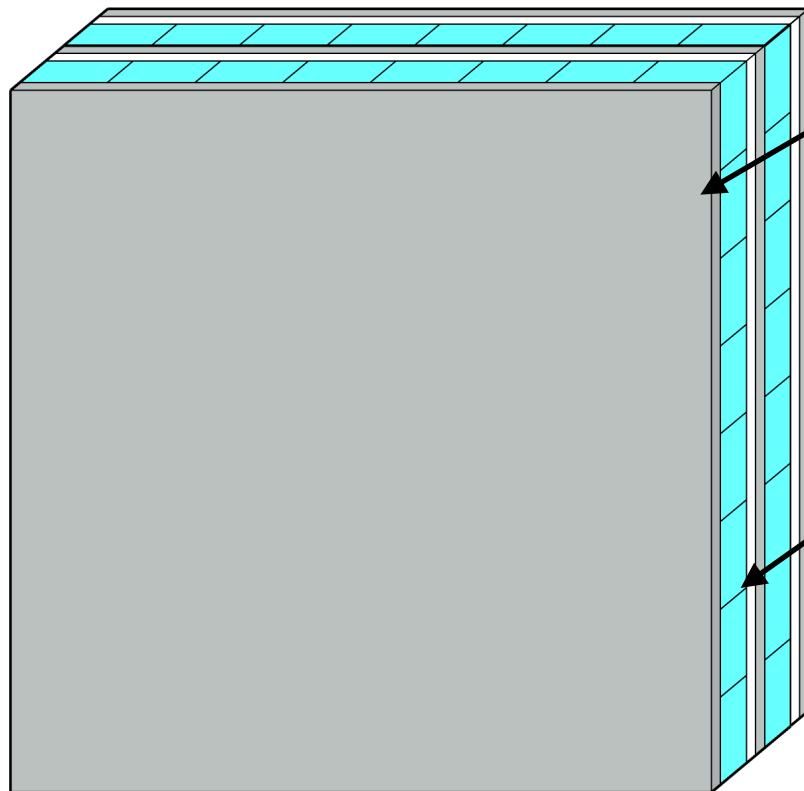

Absorber:

- different thickness: 1mm, 2mm
- different materials: lead, copper
- Changes sampling fraction and Moliere radius (size of shower)

Active elements:

- different cell sizes: 5mm - 40mm
- Changes “image resolution” and channel count

Goal: understand scaling behaviour of detector response with geometrical parameters

Influence of the Absorber



Inner granularity: 20mm, Outer granularity: 40mm, 14mm titanium vessel

Angular resolution

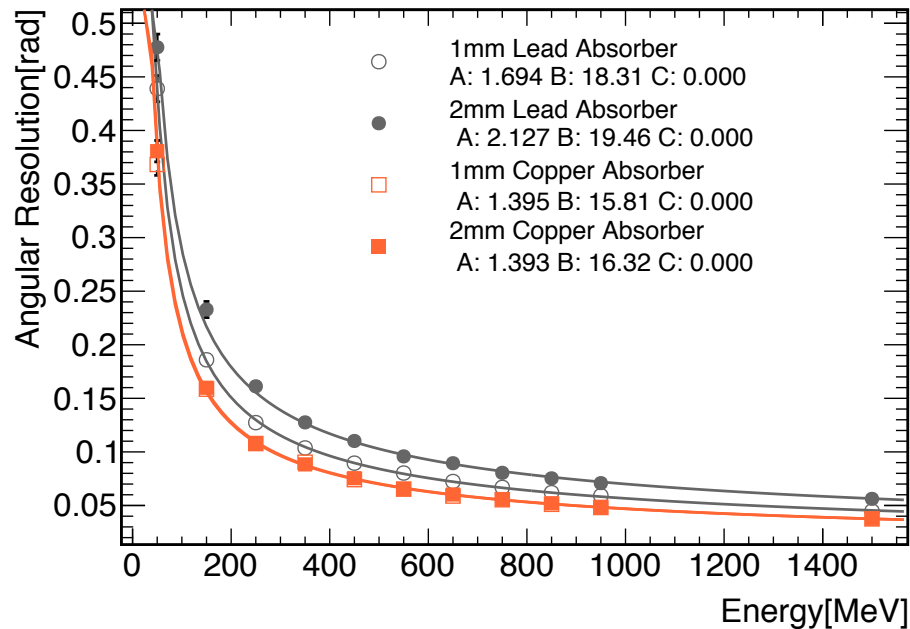

Energy resolution

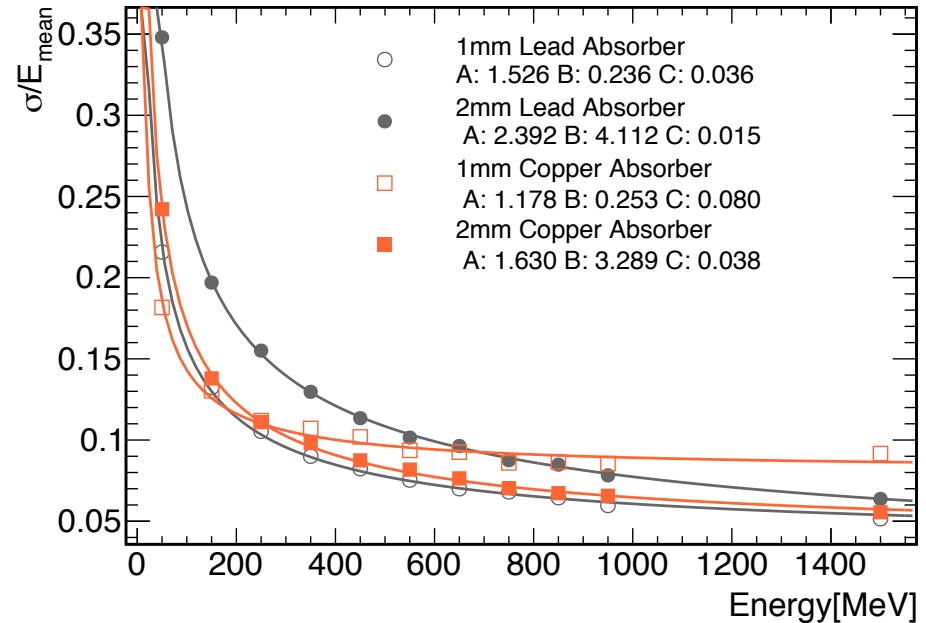

Influence of the Absorber



Inner granularity: 20mm, Outer granularity: 40mm, 14mm titanium vessel

Relative angular resolution

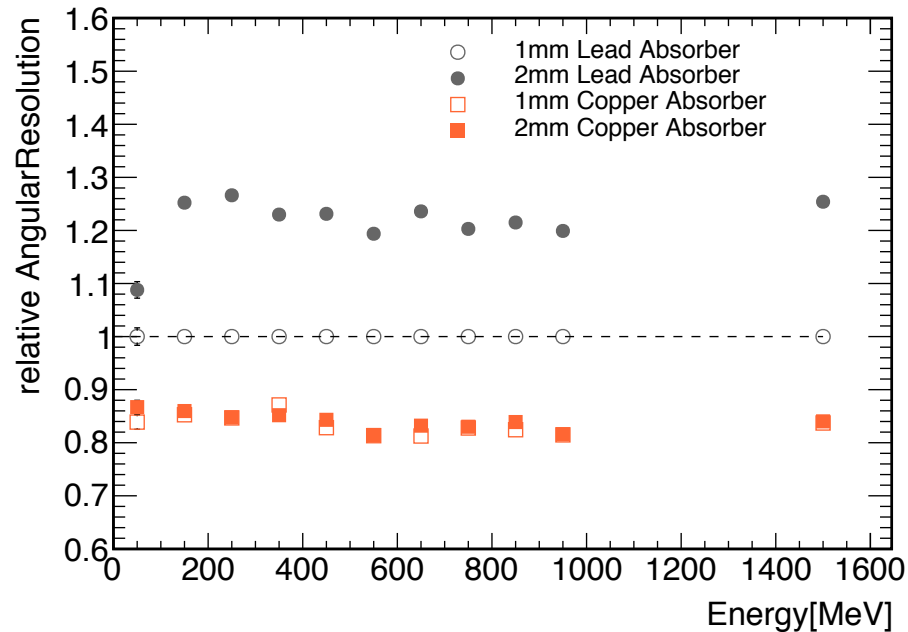

Relative energy resolution

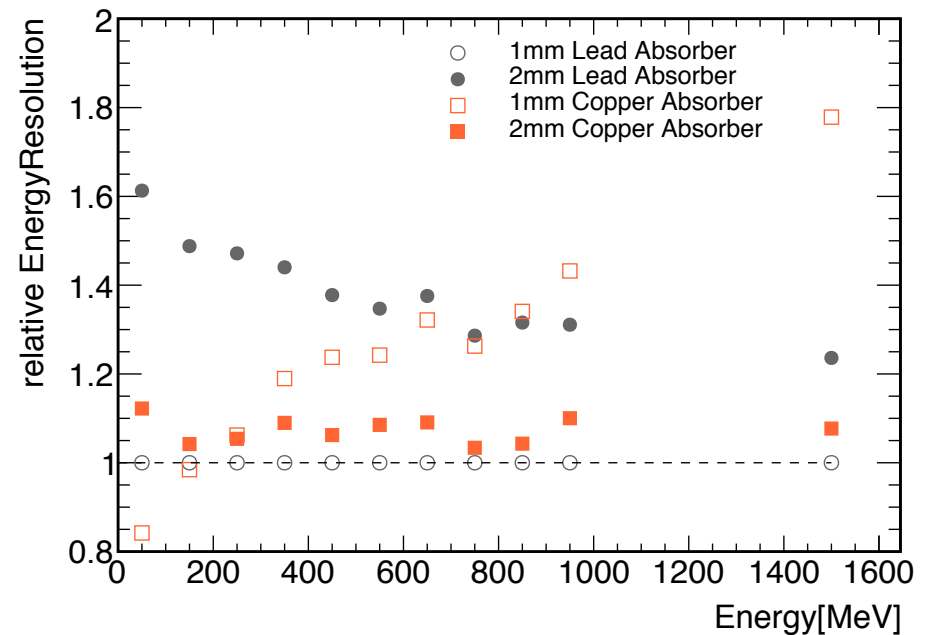

$$\text{Relative Angular Resolution} = \frac{\text{Angular Resolution [rad]}}{\text{Default Angular Resolution [rad]}}$$

Influence of the Absorber



Inner granularity: 20mm, Outer granularity: 40mm, 14mm titanium vessel

Relative angular resolution

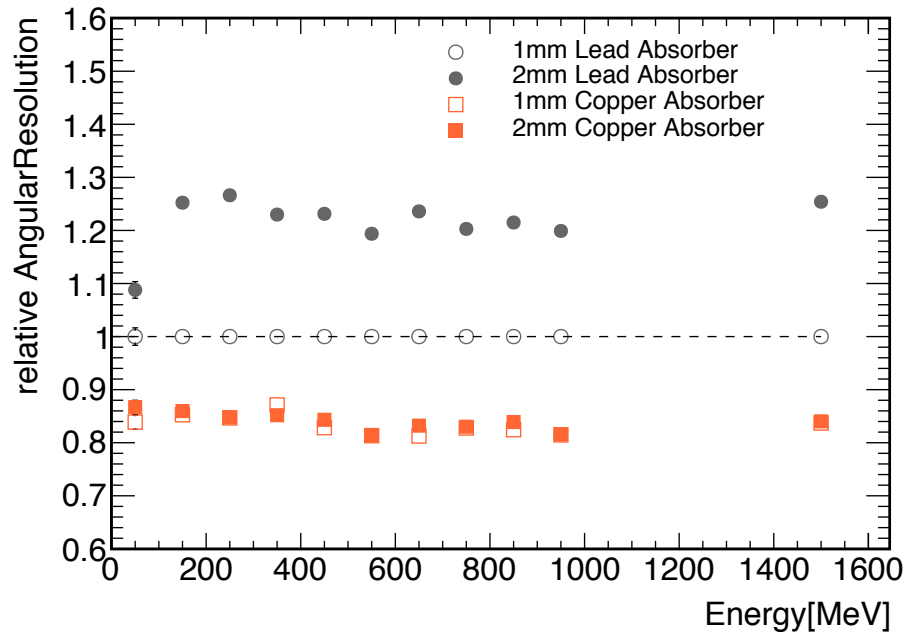



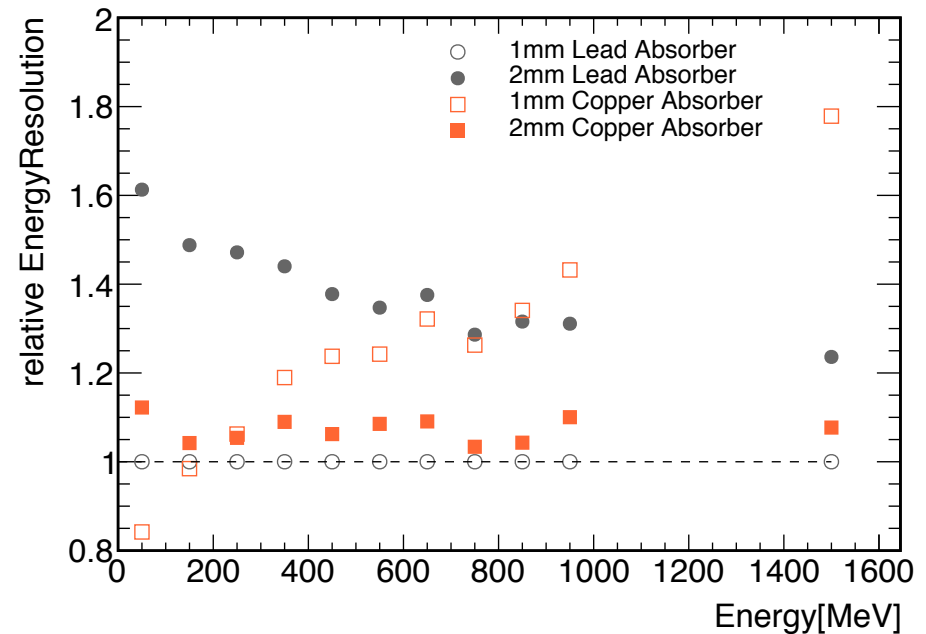







Relative energy resolution



Conclusion: Copper yields better angular resolution, but 1mm copper is leaking very much energy

Overview



	Angular Resolution	Energy Resolution
Titanium Vessel	Default	Default
Lead Absorber	Default	Default
NO Vessel		
Steel Vessel		
Copper Absorber		
Higher granularity in inner calorimeter		
High granularity in outer calorimeter		

Pion Reconstruction

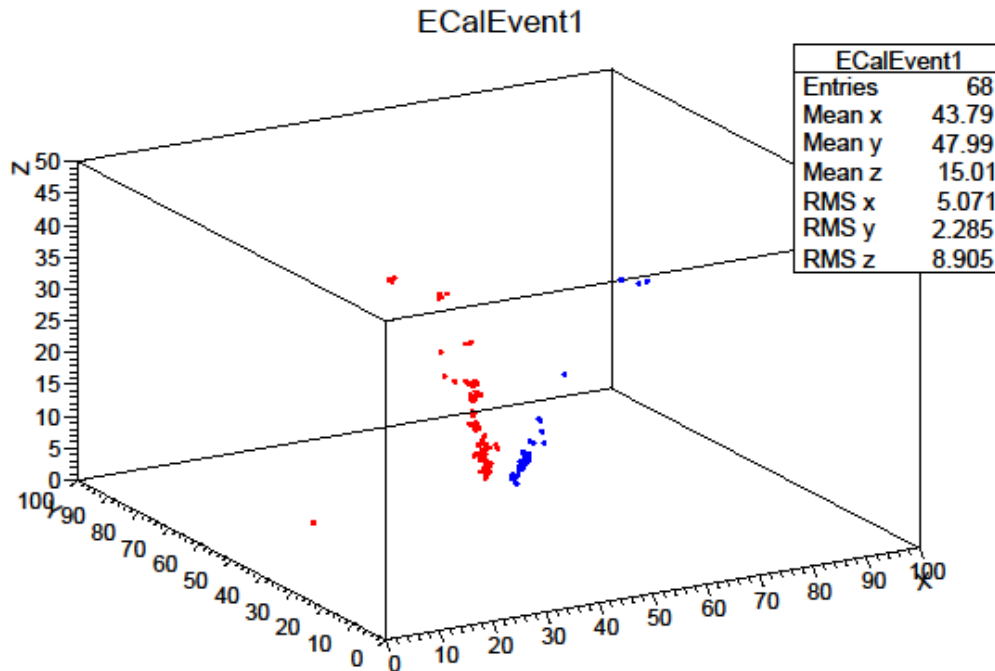

- Distinguish **photon1** from **photon2** by Monte Carlo truth

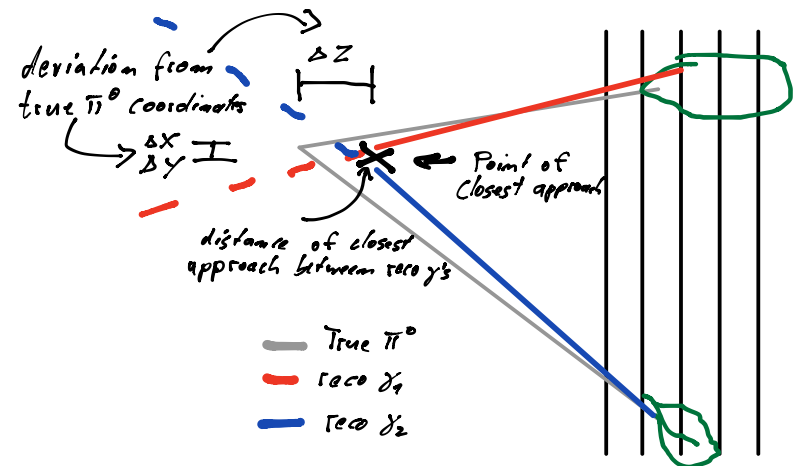

- Take point of closest approach of the reconstructed tracks as decay vertex
- Look at uncertainty of reconstructed vertex in 3D: $\Delta d = \sqrt{\Delta x^2 + \Delta y^2 + \Delta z^2}$

Pion Reconstruction

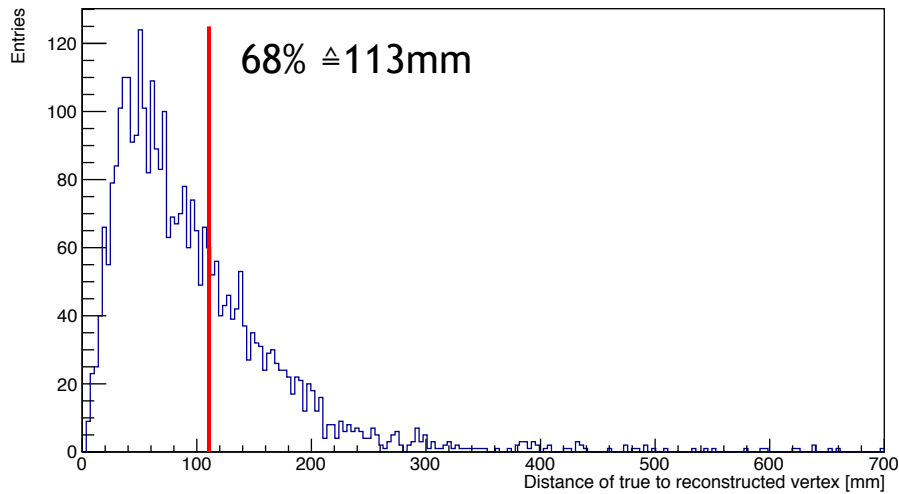

- 450MeV
- 1mm lead absorber
- Inner granularity 20mm, outer granularity 40mm

Pion Reconstruction

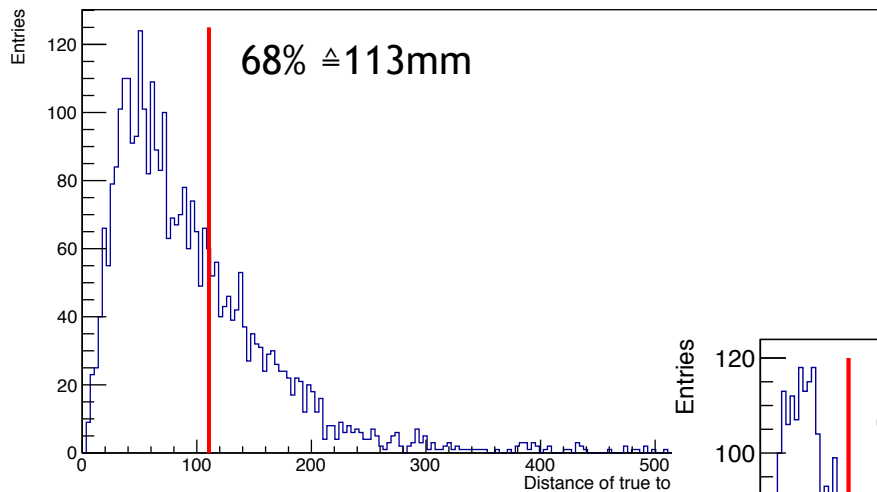

- 450MeV
- 1mm lead absorber
- Inner granularity 20mm, outer granularity 40mm

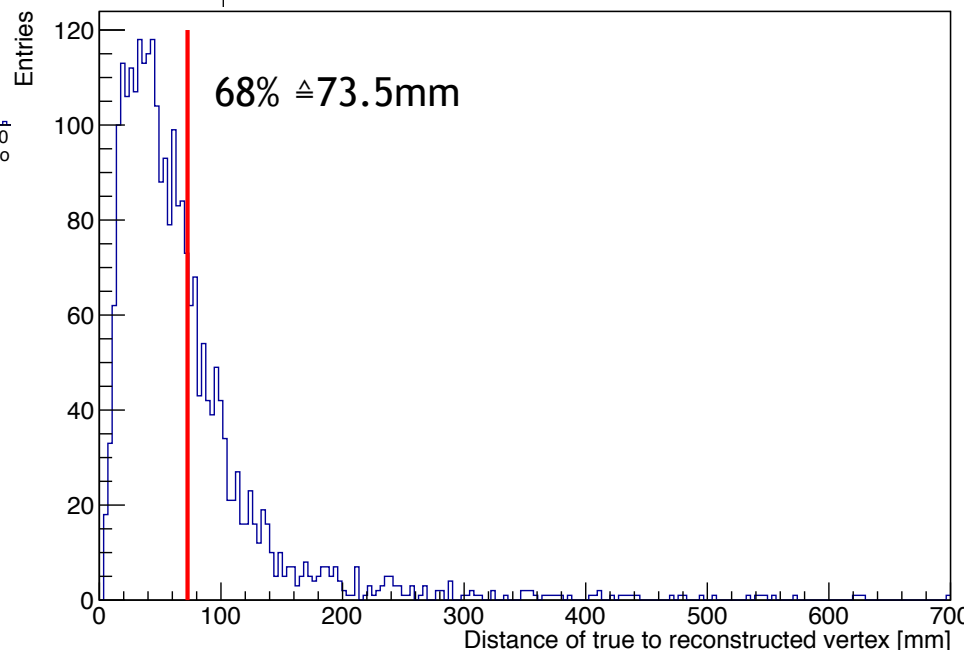

- 450MeV
- 2mm copper absorber
- Inner granularity 30mm, outer granularity 40mm

Hardware Studies



- Readout of individual scintillator tiles is a well established technology:
 - CALICE, BEAST/CLAWS
- Study possibilities to achieve high effective granularity with smaller channel count
 - Several tiles with projective fiber readout ready/in production at the MPP

Hardware Studies



Several tiles with projective fiber readout ready/in production at the MPP

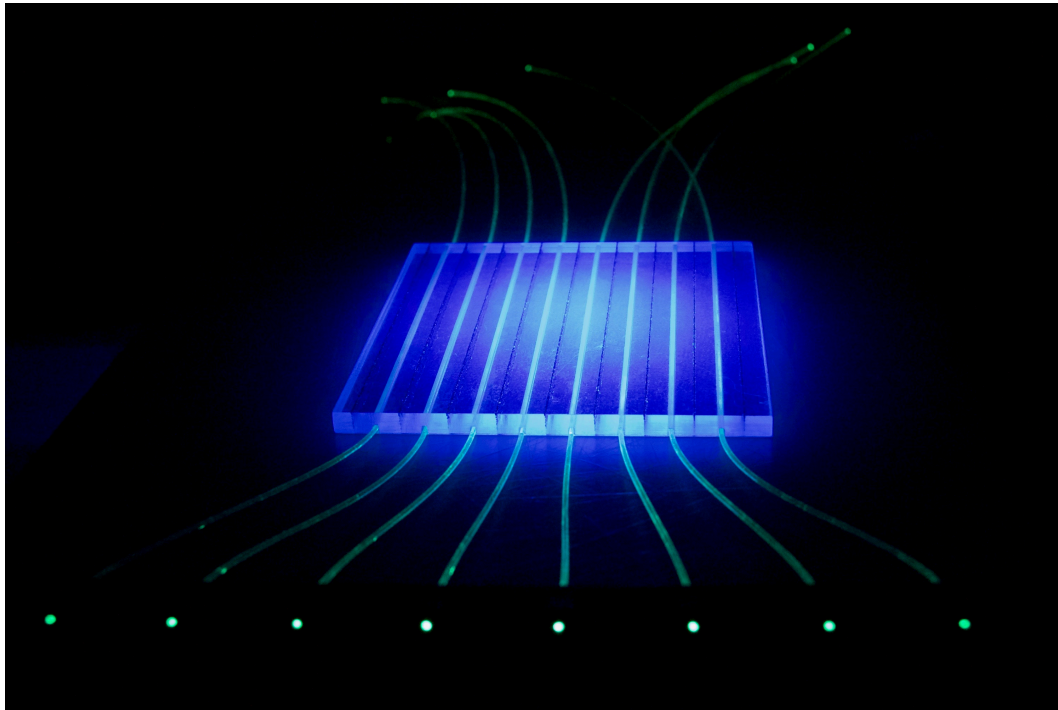

- 90x90x5mm scintillator tile
- 8 fibers separated by 10mm
- Sub surface laser engraved optical barriers to separate channels
- SiPM readout for every fiber

Try to achieve higher granularity with crossed strip geometry
→ Use two tiles with orthogonally aligned strips

Summary and Outlook



- Pressure vessel worsens energy resolution in general
 - 14mm Titanium has less negative impact than 20mm Steel
 - Absorber material influences angular and energy resolution
 - Copper is better than lead
 - Granularity in first few X_0 influences overall angular resolution
- Pion reconstruction can be improved with information on angular and energy resolution

Backup

Backup

Pi0 Distribution

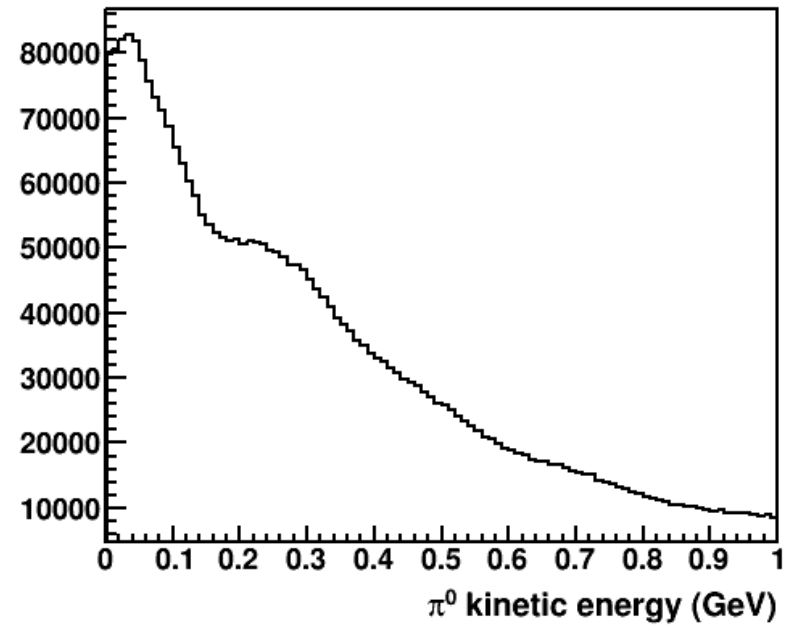
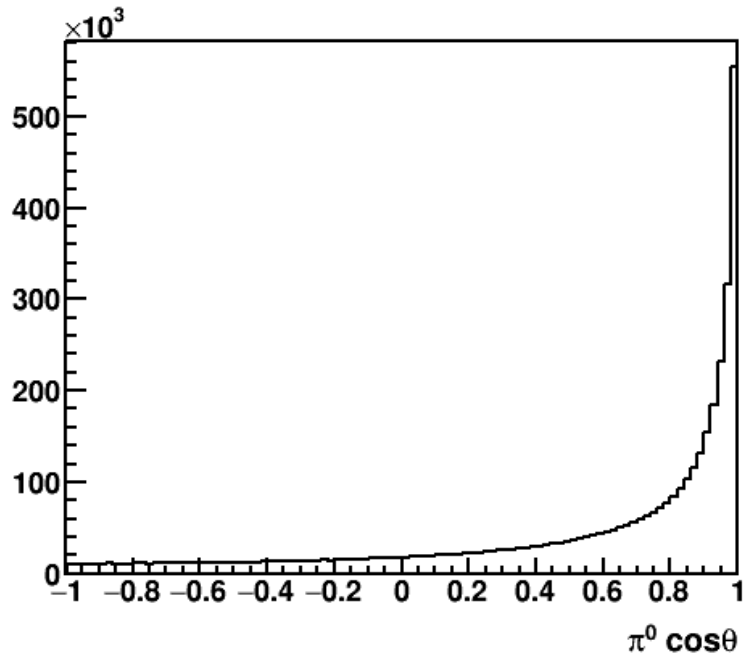

Influence of the Pressure Vessel

1mm lead absorber, Inner granularity: 20mm, Outer granularity: 40mm

Angular resolution

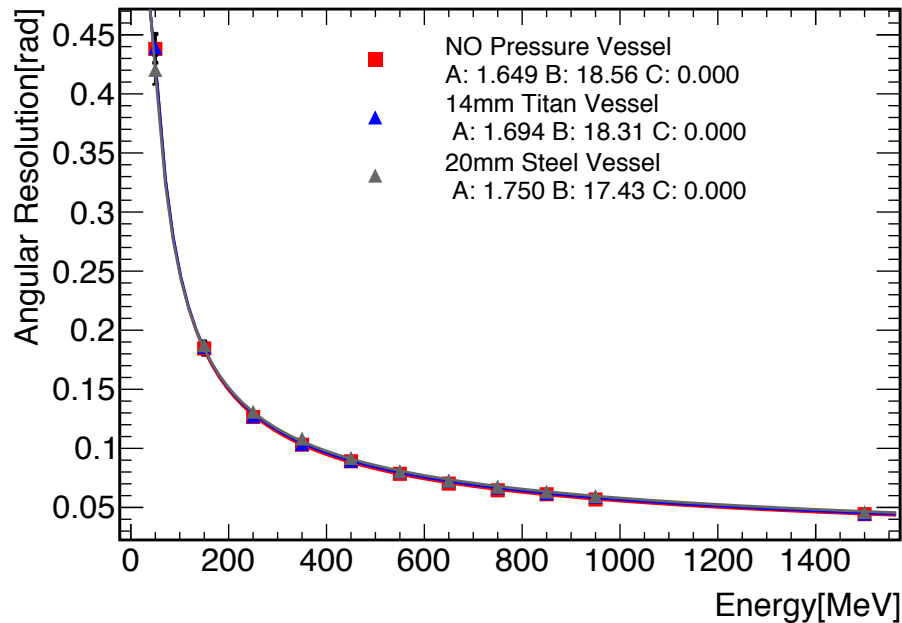

Energy resolution

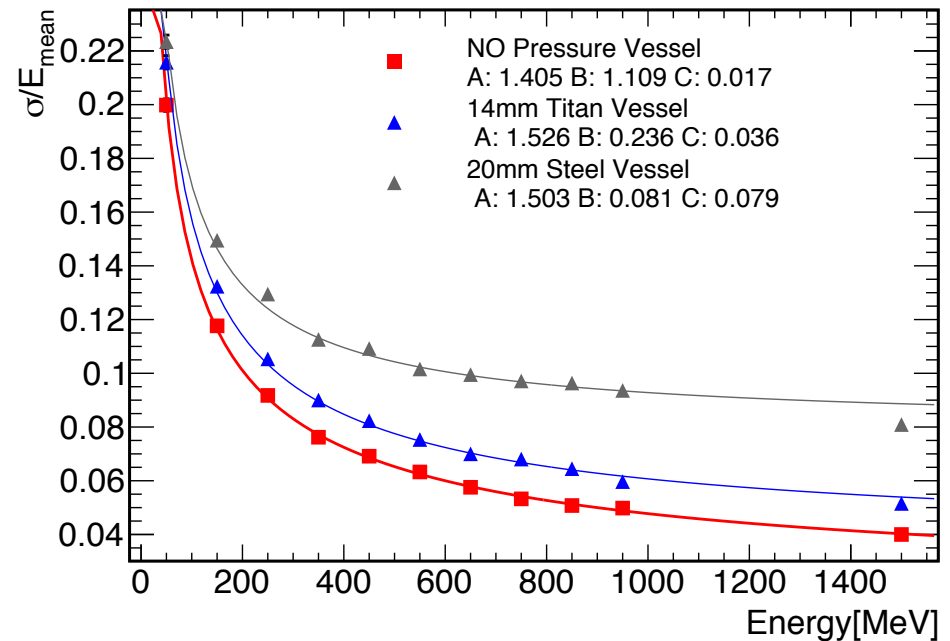

Influence of the Pressure Vessel

1mm Lead absorber, Inner granularity: 20mm, Outer granularity: 40mm

Relative angular resolution

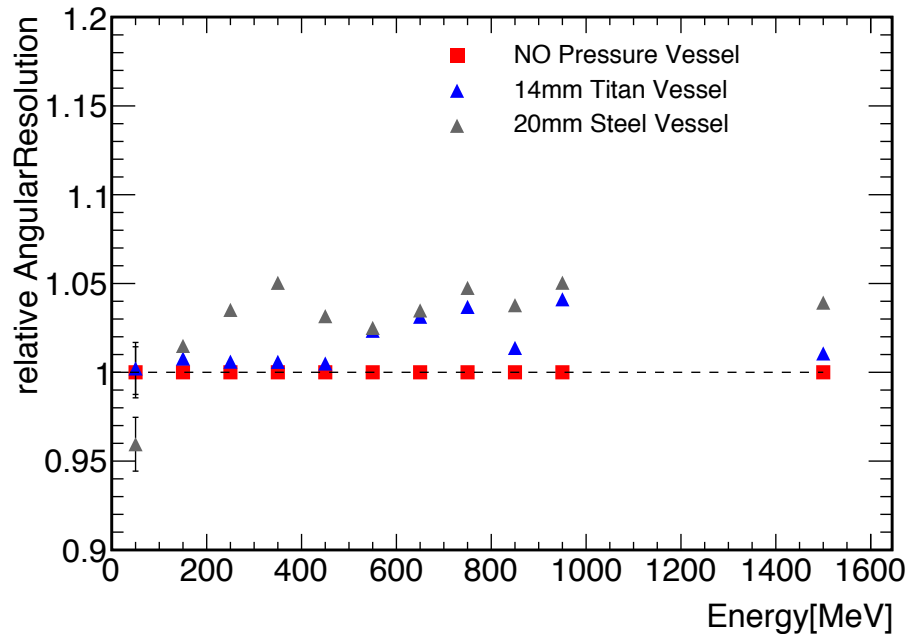

Relative energy resolution

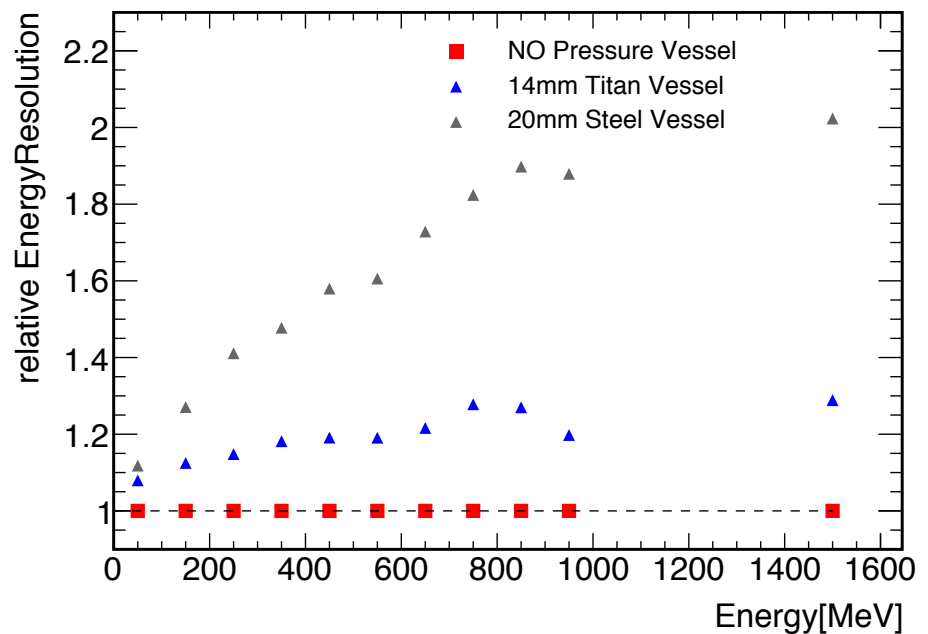

Conclusion: Thin titanium pressure vessel yields better results

Influence of Inner Granularity

1mm Lead absorber, Outer Granularity: 40mm, 14mm Titanium vessel

Angular resolution

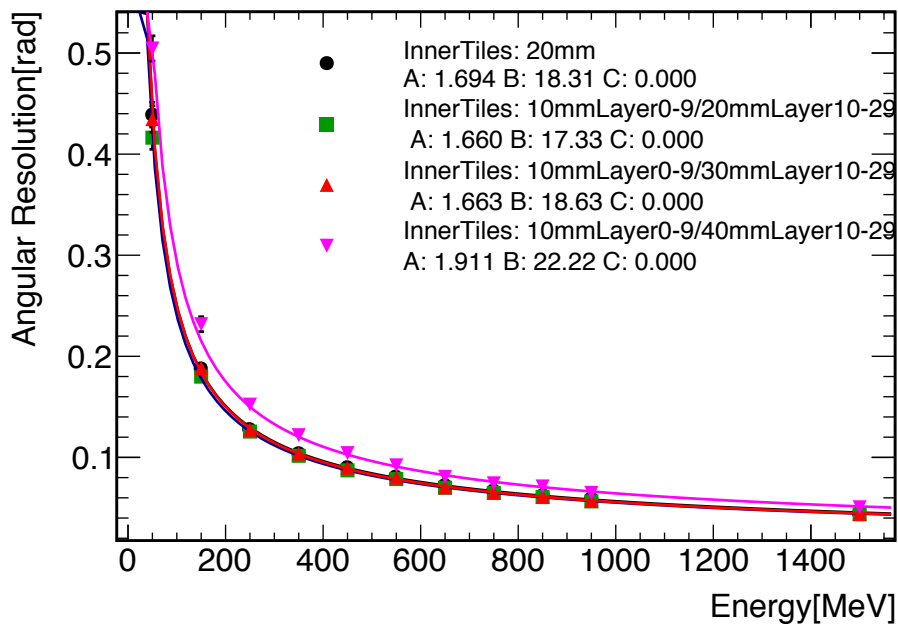

Relative angular resolution

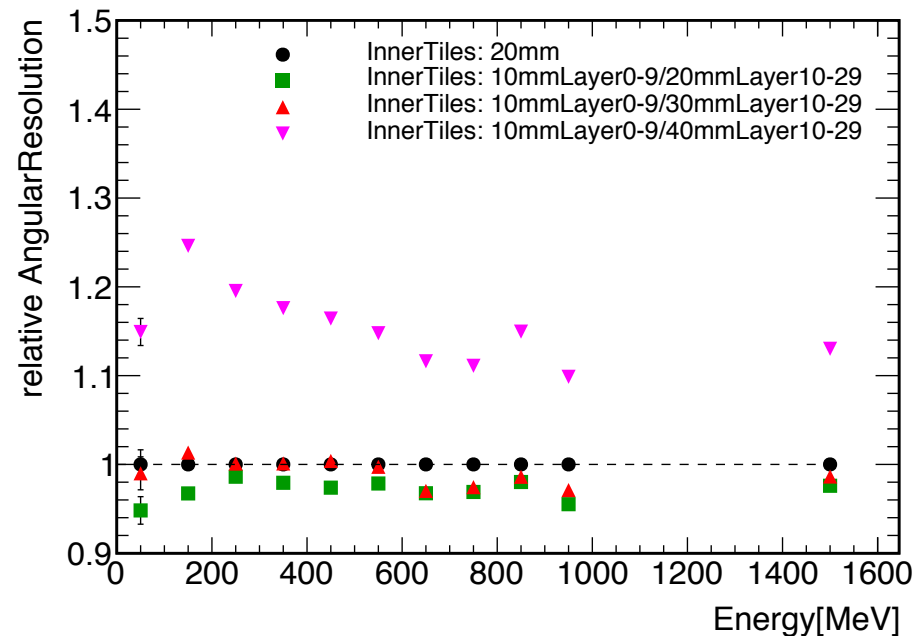

Conclusion: Granularity in first few X_0 has a major influence on overall angular resolution

Influence of Inner Granularity



Reminder: ECal is split into inner and outer part by the pressure vessel
→ Look at impact of inner cell size on angular resolution

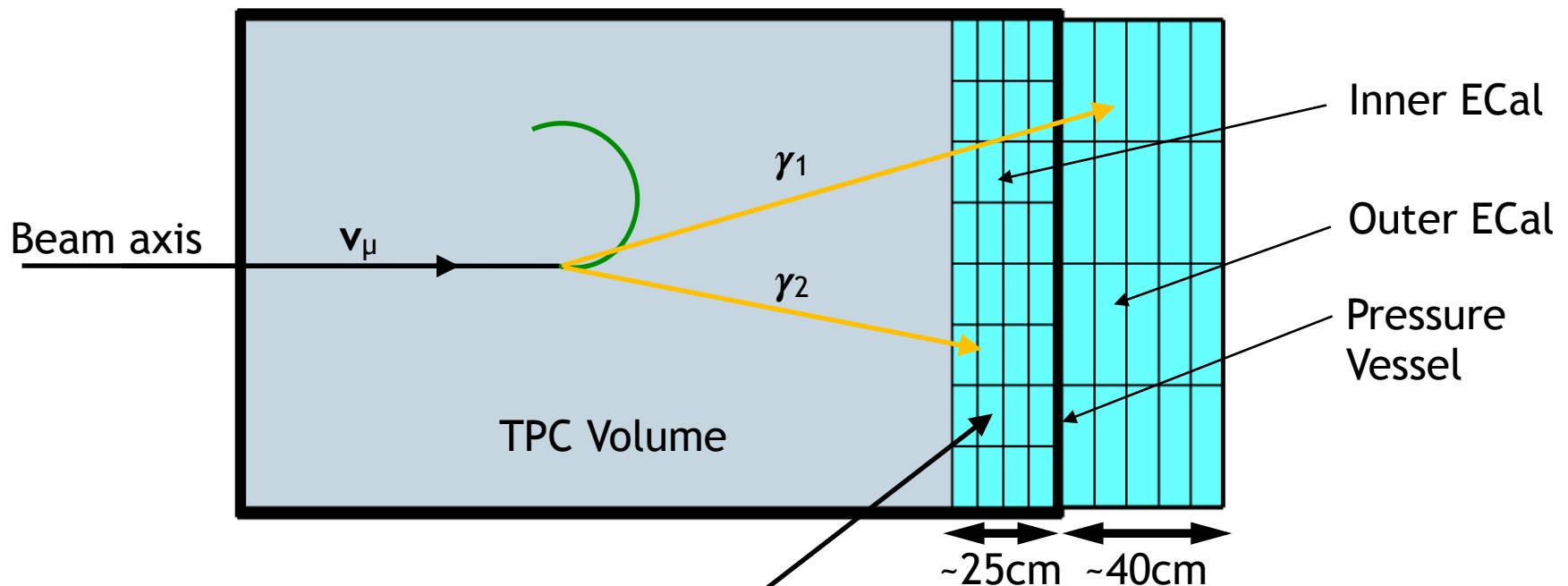

Compare angular resolution for different cell sizes

Influence of Inner Granularity



Angular resolution

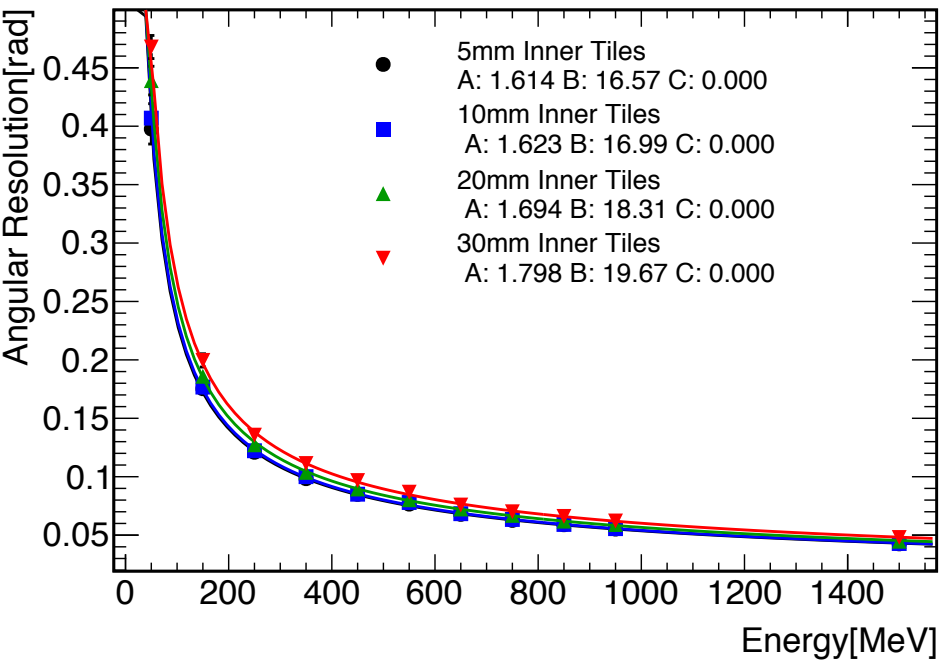

Influence of Inner Granularity



Relative angular resolution

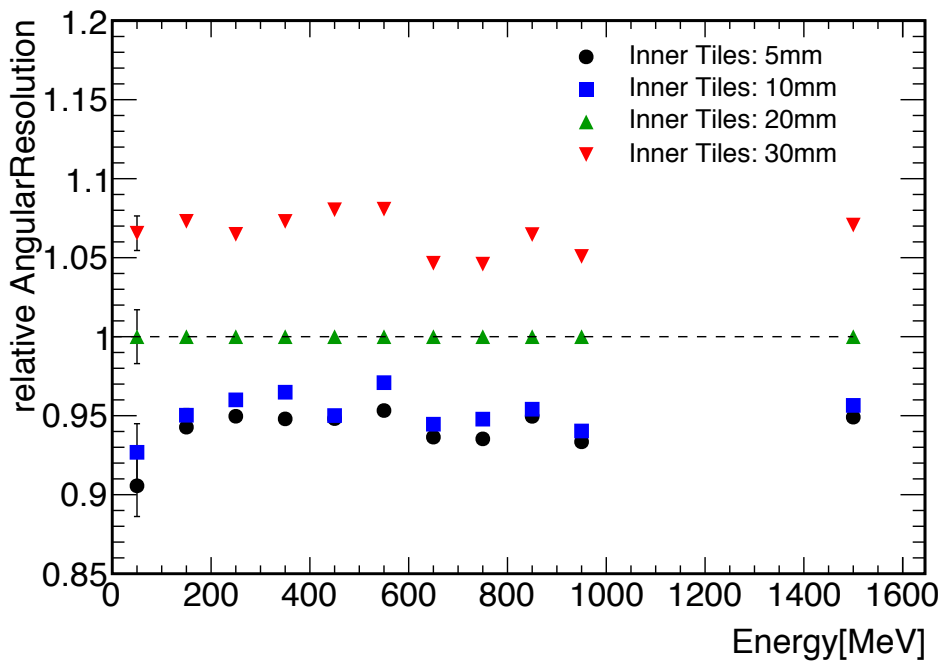

$$\text{Relative Angular Resolution} = \frac{\text{Angular Resolution [rad]}}{\text{Default Angular Resolution [rad]}}$$

Influence of Mixed Granularity



Increase granularity in first few X_0

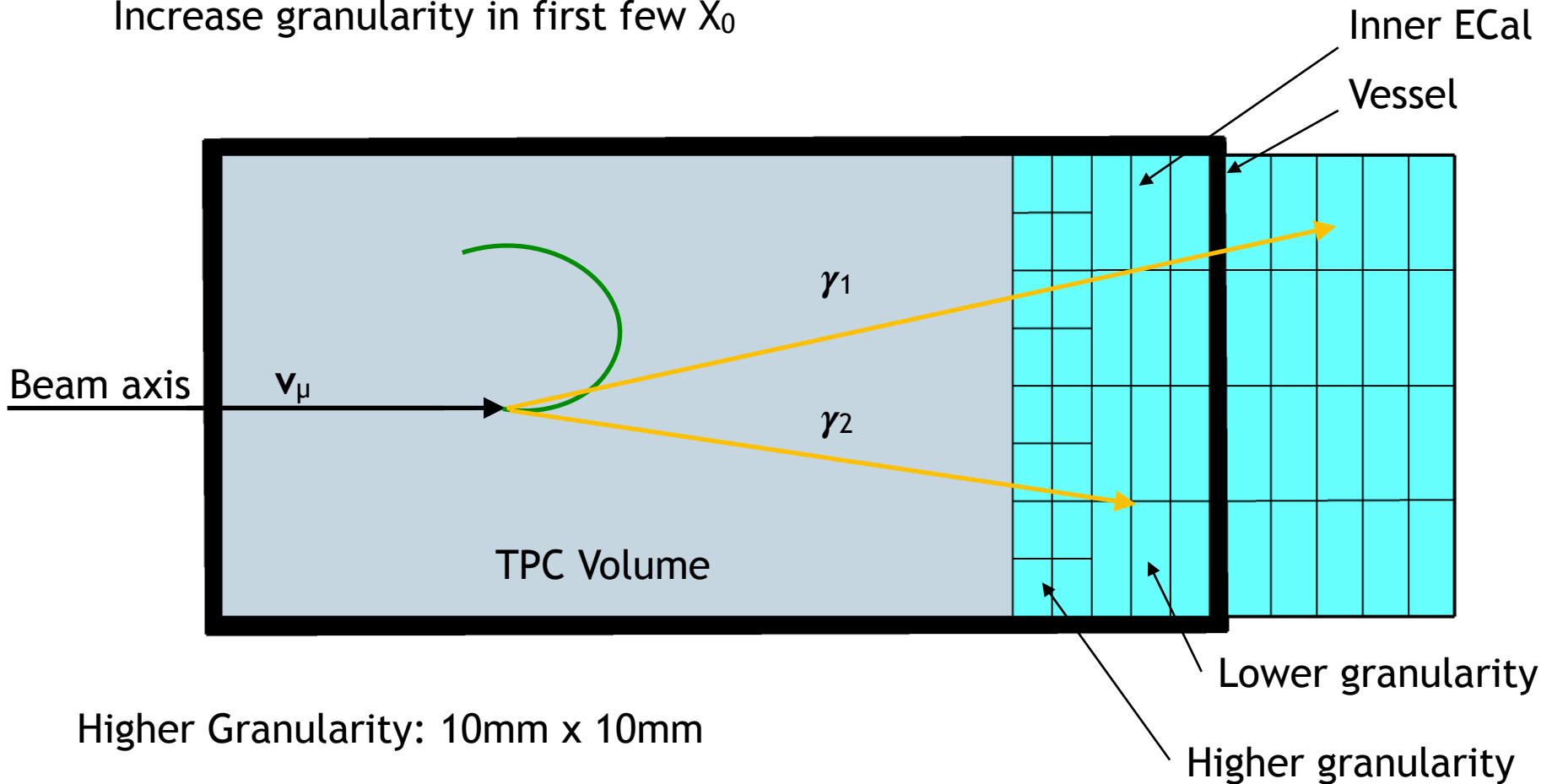

Higher Granularity: 10mm x 10mm

Lower Granularity: 20mm x 20mm, 30mm x 30mm

Influence of Mixed Granularity



Relative angular resolution
Homogeneous granularity

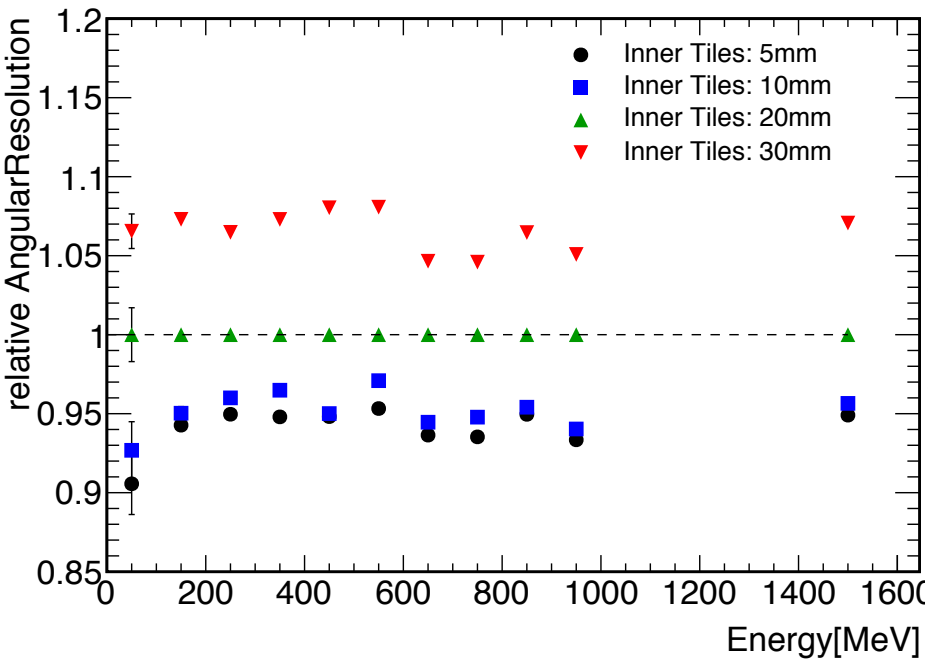

Relative angular resolution
Mixed granularity

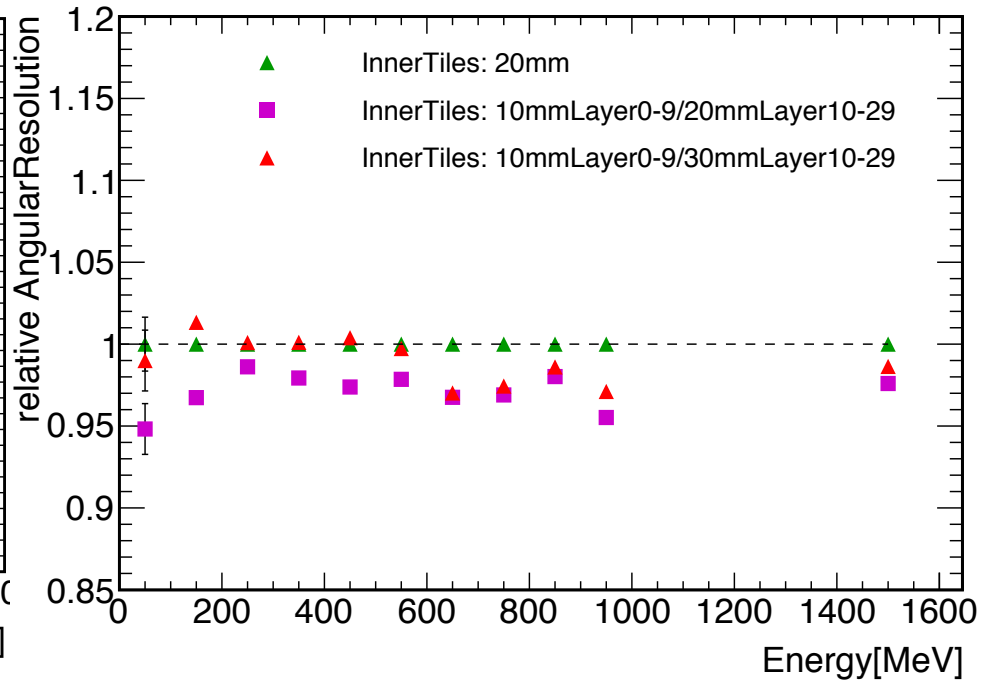

Conclusion: Granularity in first few X_0 has a major influence on overall angular resolution

Pion Reconstruction

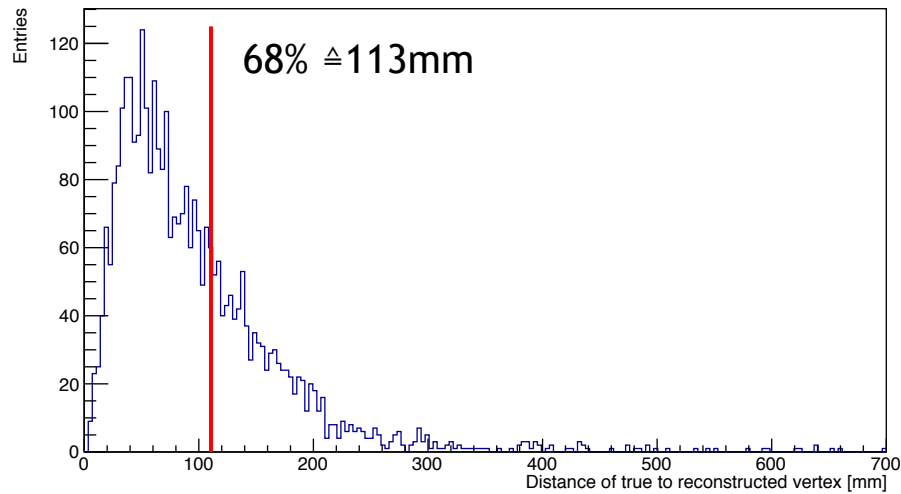

- 450MeV
- 1mm lead absorber
- Inner granularity 20mm, outer granularity 40mm

Pion Reconstruction

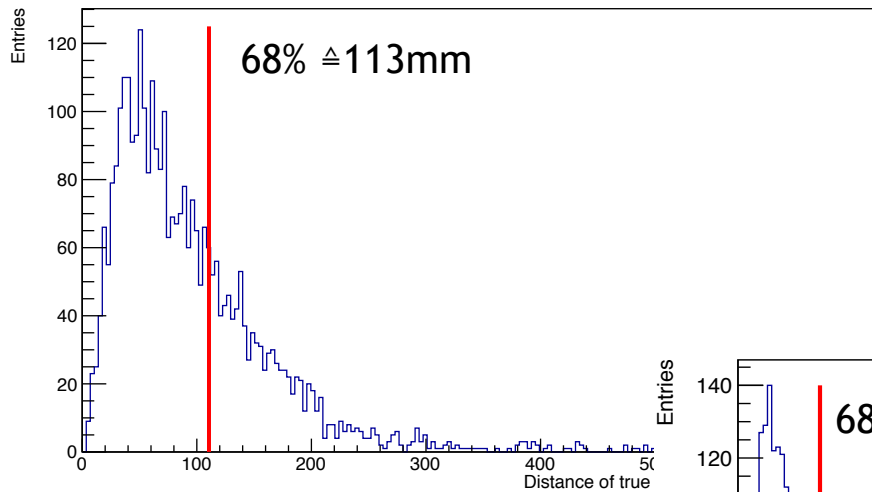

- 450MeV
- 1mm lead absorber
- Inner granularity 20mm, outer granularity 40mm

- 450MeV
- 2mm copper absorber
- Inner granularity 20mm, outer granularity 40mm

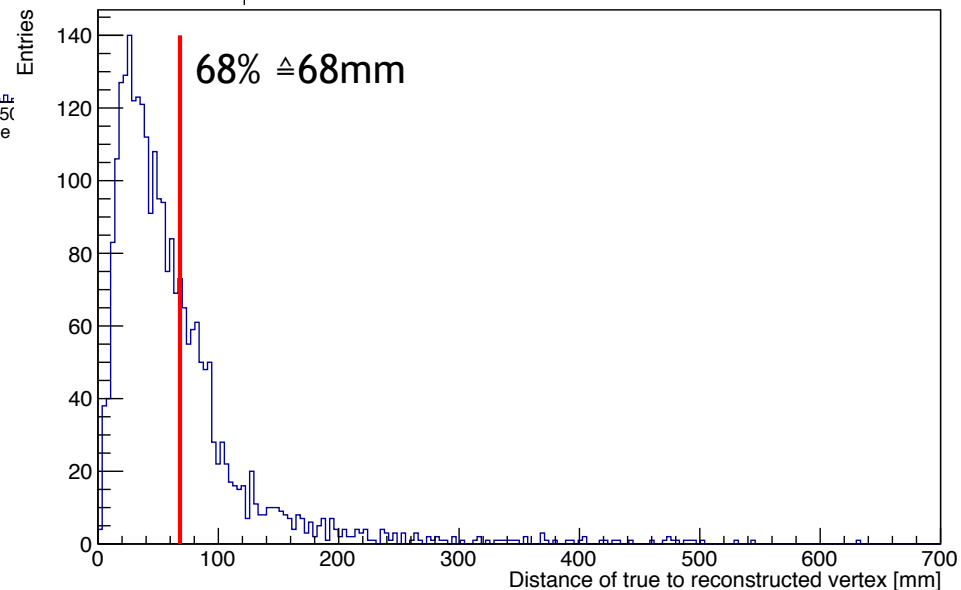

Hardware Studies



Several tiles with projective fiber readout ready/in production at the MPP

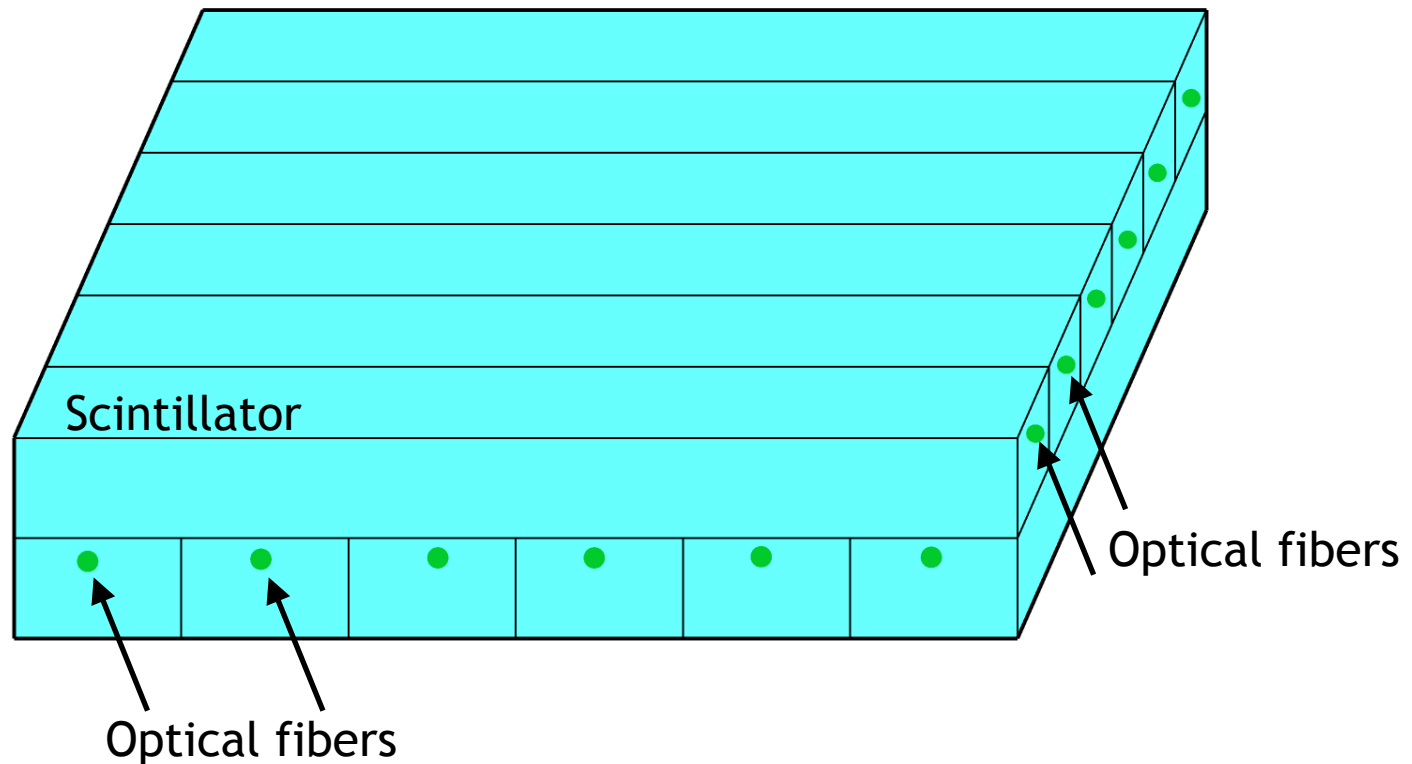

Try to achieve higher granularity with crossed strip geometry

Showerprofile 1mmLead

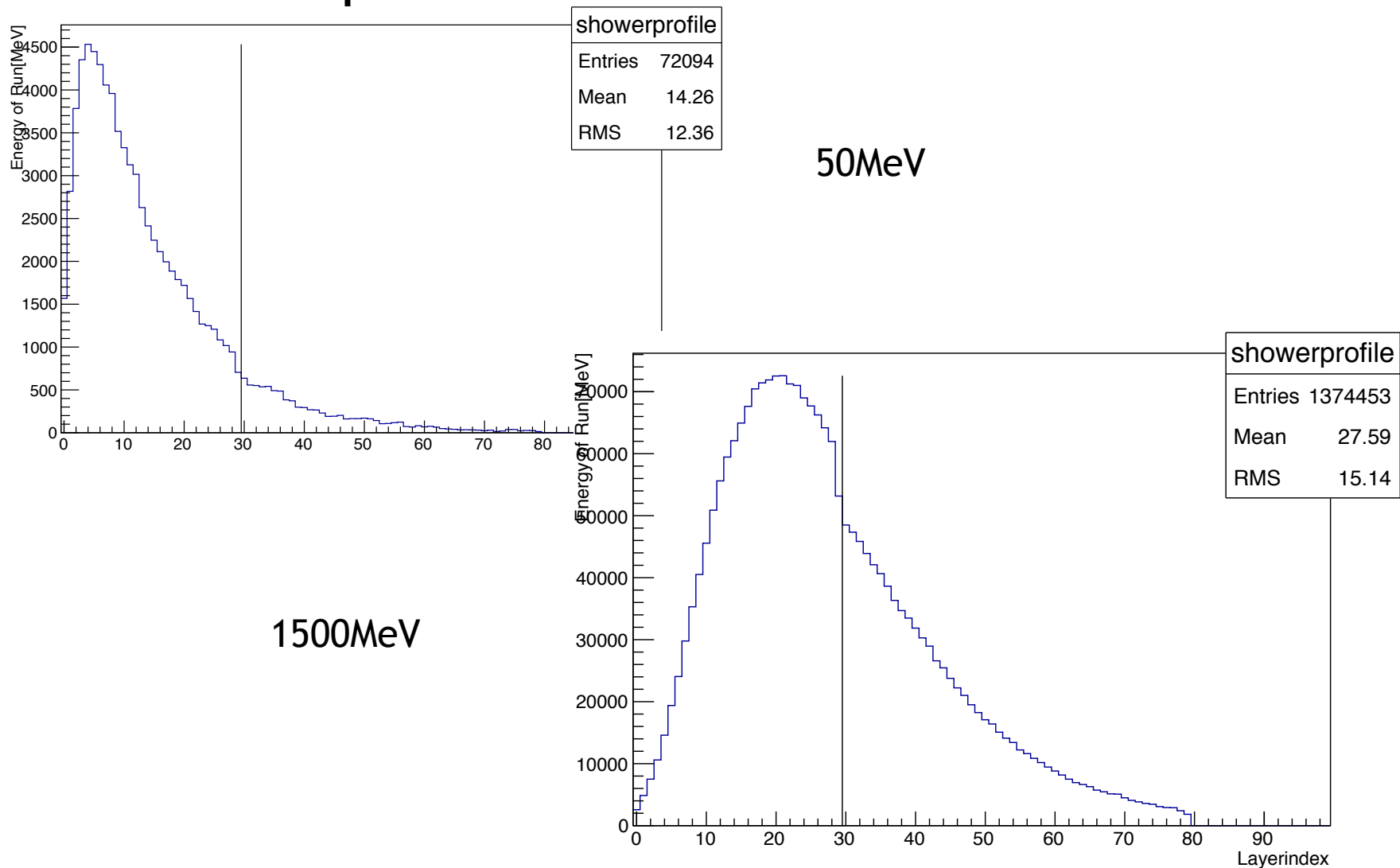

Showerprofile 2mmLead

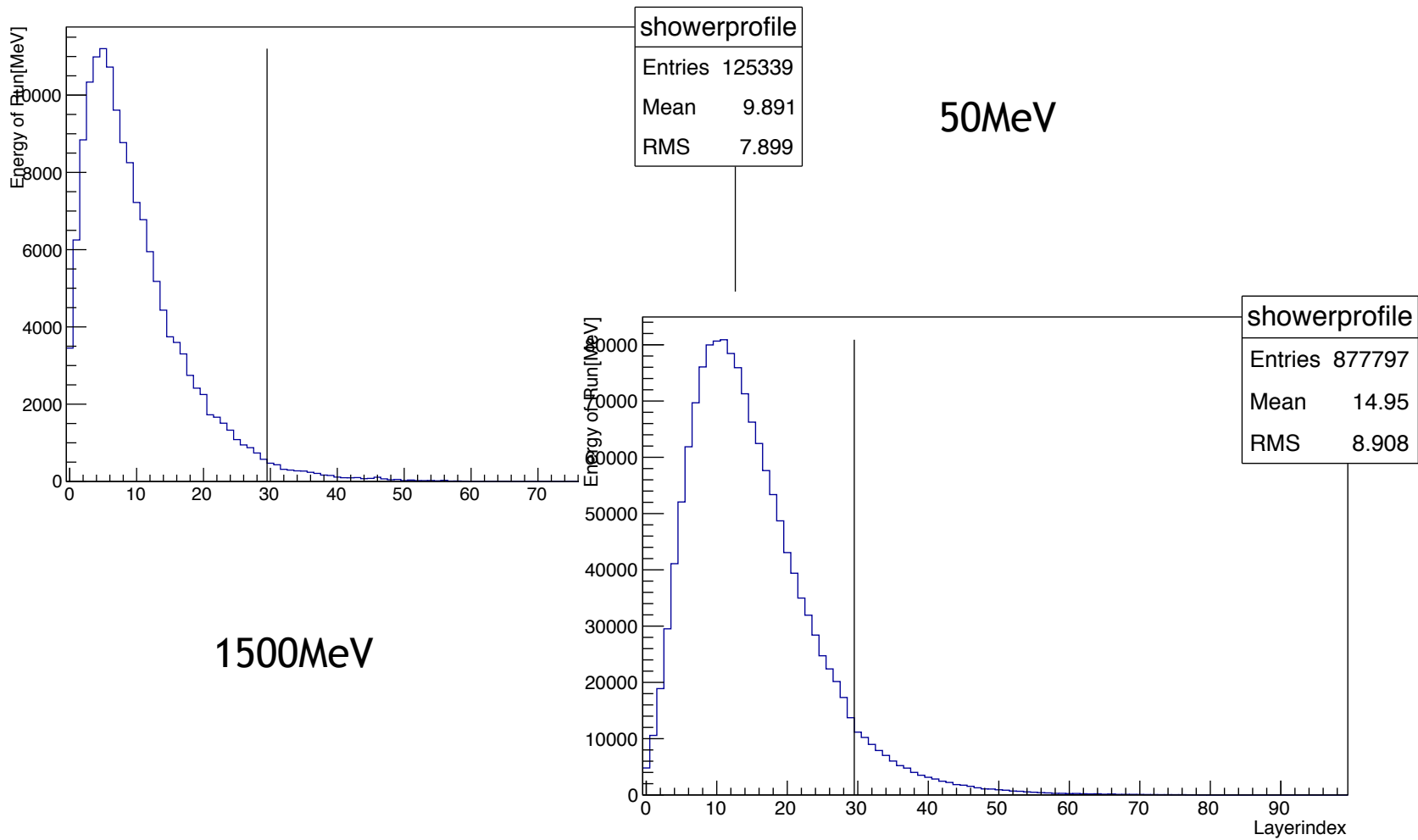

Hardware Studies

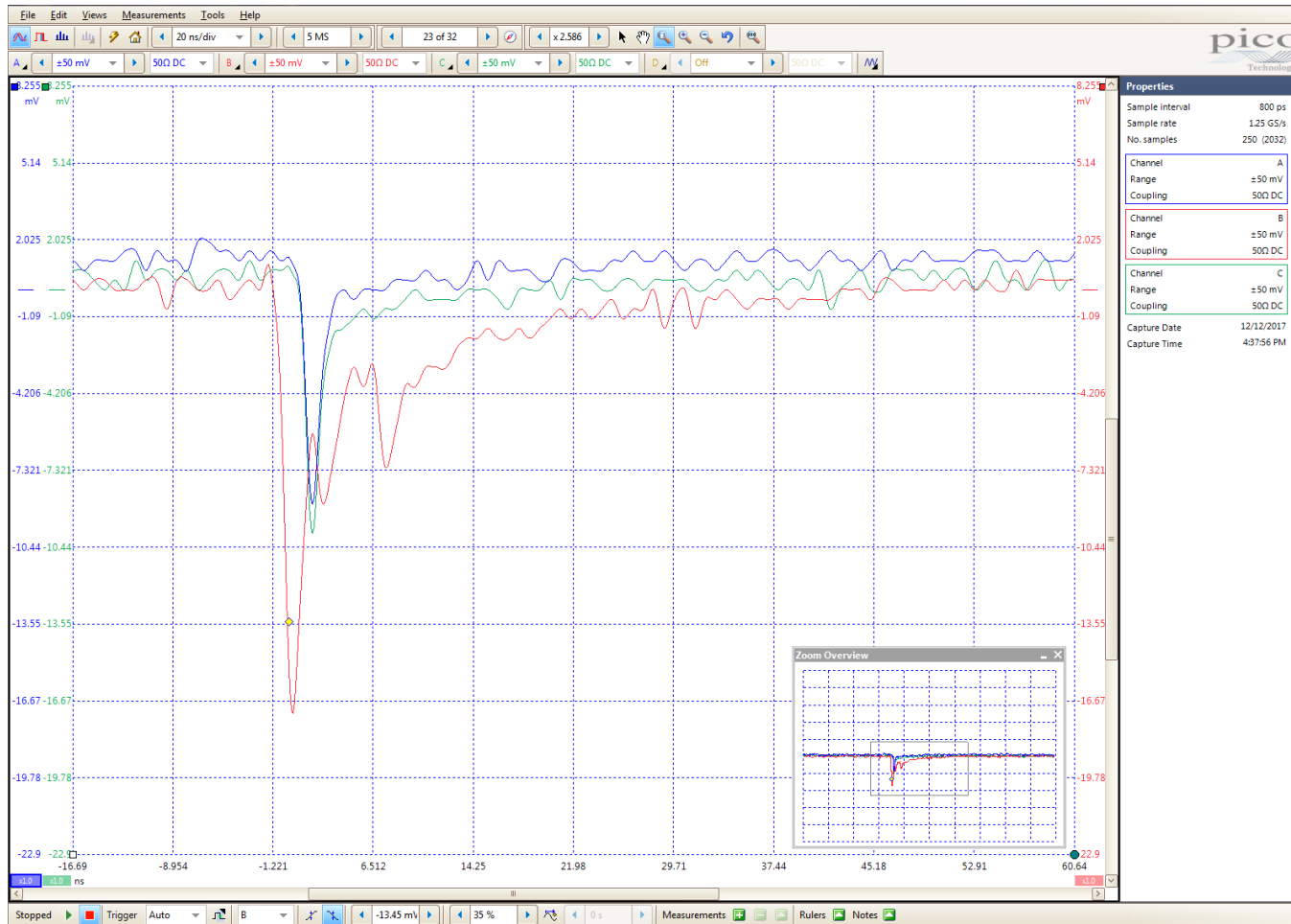

- Source on top of **Channel 2**
- Direct neighbours:
 - Channel 1
 - Channel 3

Fiber Readout

