

Particle Physics with Accelerators and Natural Sources

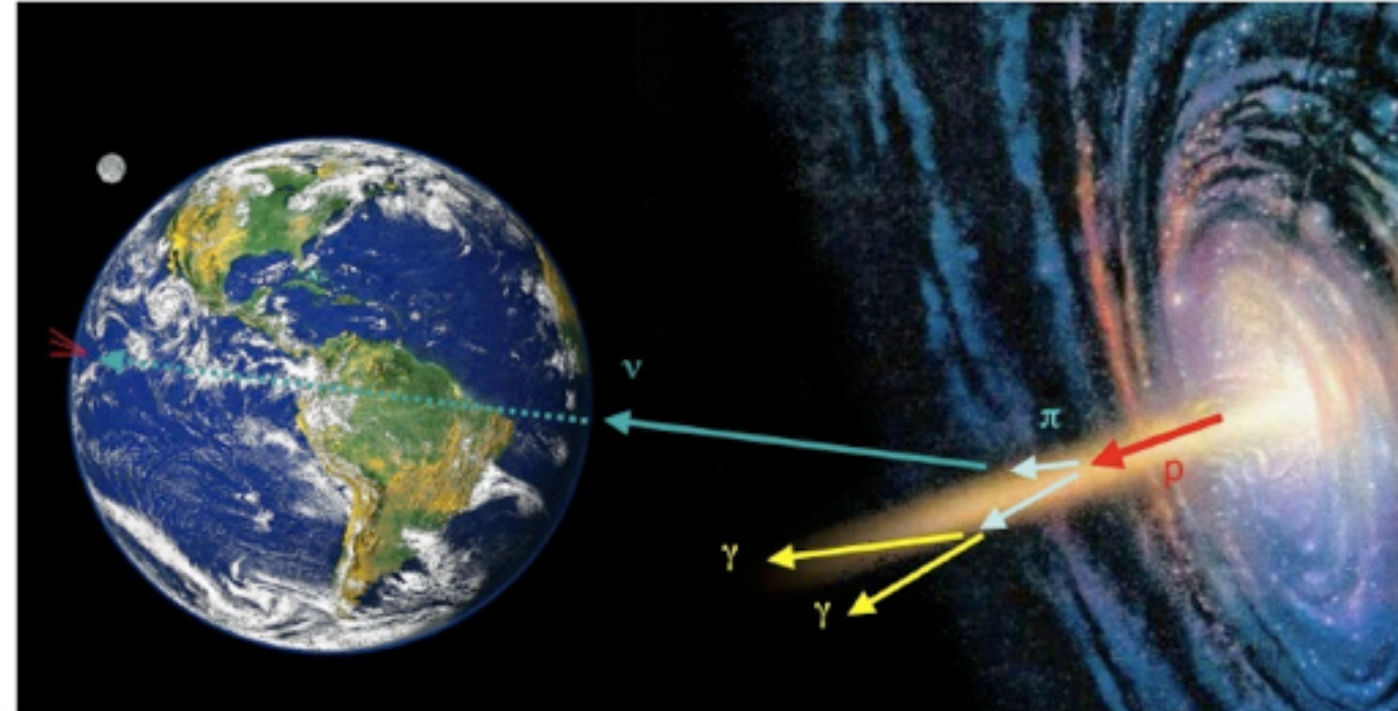

11. Gravitational Waves

15.07.2019

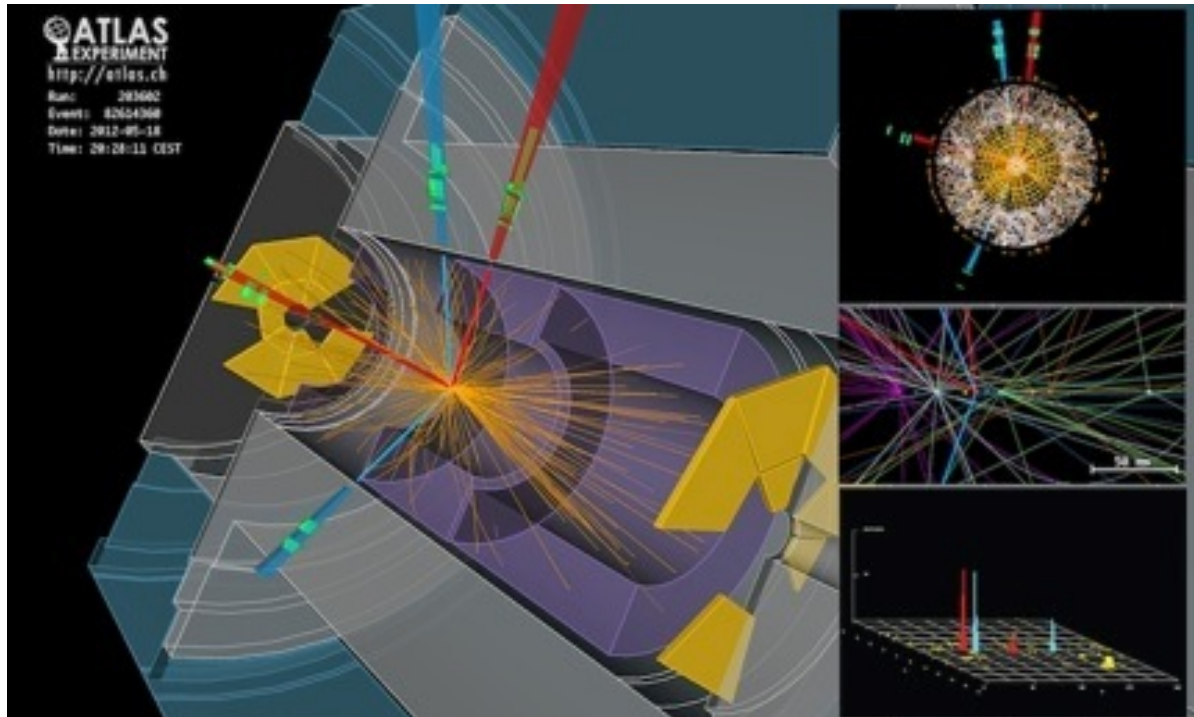

Overview

- A few words on Gravity & Gravitational Waves
- How to measure Gravitational Waves
- First Results, Interpretation & Sources
- Future Ideas

Gravity and Space Time

- Classical description of Gravity by Newton - 1687

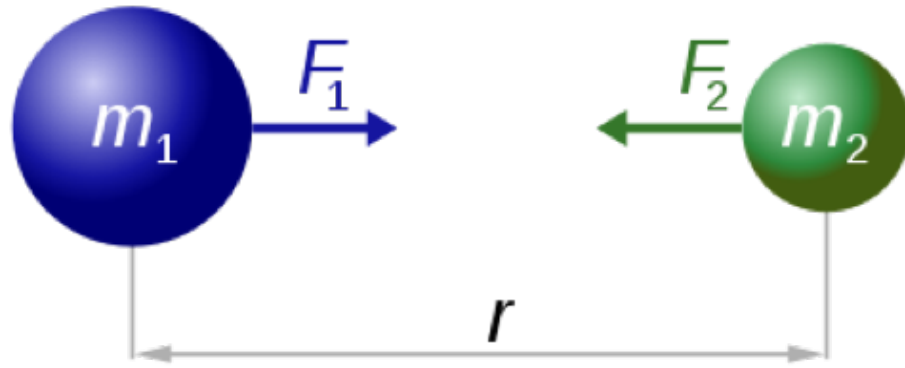

$$F_1 = F_2 = G \frac{m_1 \times m_2}{r^2}$$

- Describes movement of celestial bodies - successful prediction / discovery of Neptune in 1846

Gravity and Space Time

- In the 1850ies: Problems appear - Mercuries path around the sun slightly off from Newtonian prediction - a new planet between sun and Mercury?
Predicted 1859, called “Vulcan”

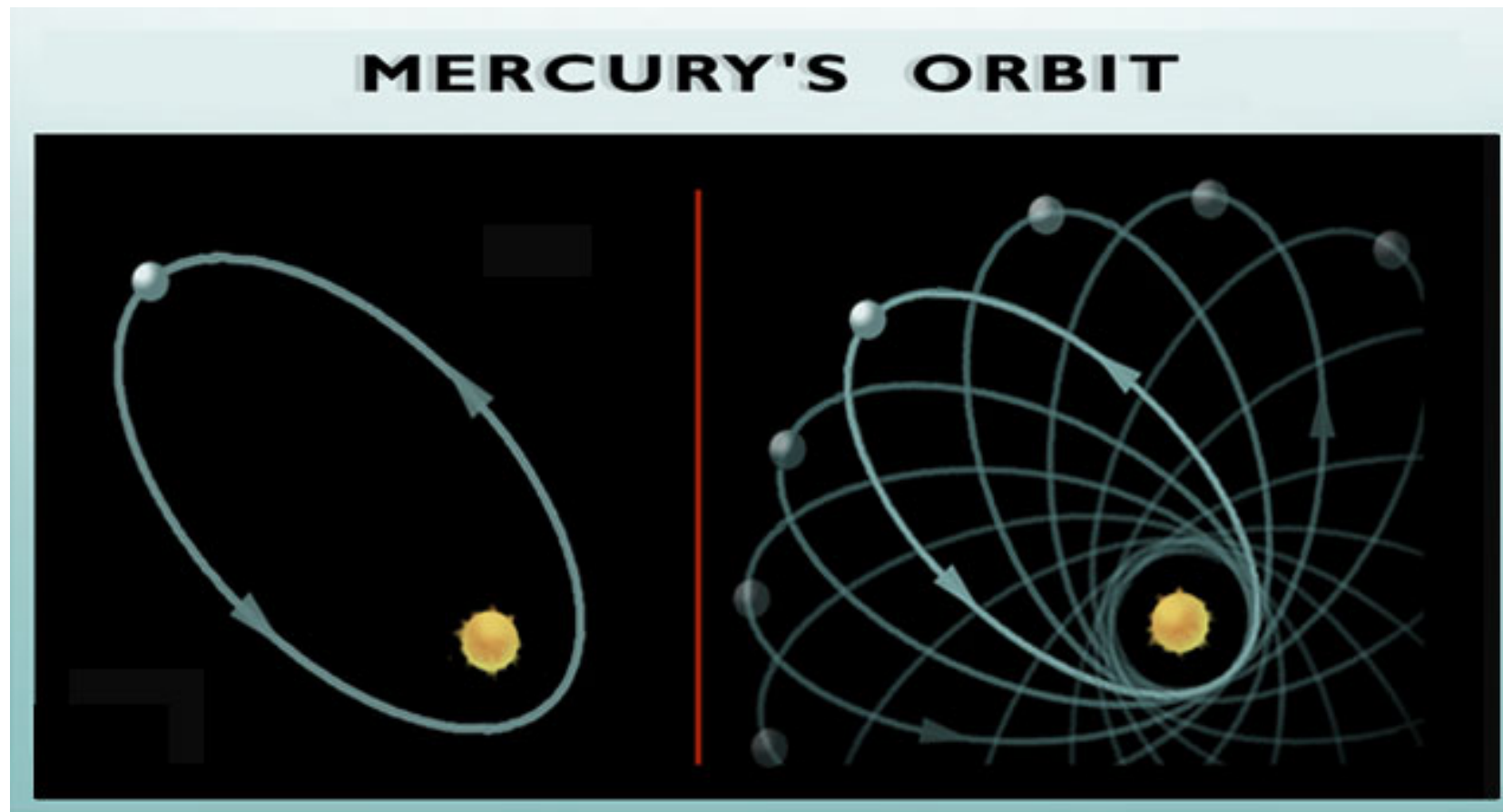

- Vulcan was never found - today we know the understanding of Gravity was the problem: General Relativity!

Gravity and Space Time

- Einstein (1915): General relativity connecting space and time: space time

$$G_{ab} \equiv R_{ab} - \frac{1}{2}g_{ab}R = \frac{8\pi G}{c^4}T_{ab}$$

- One consequence: massive objects “curve space”

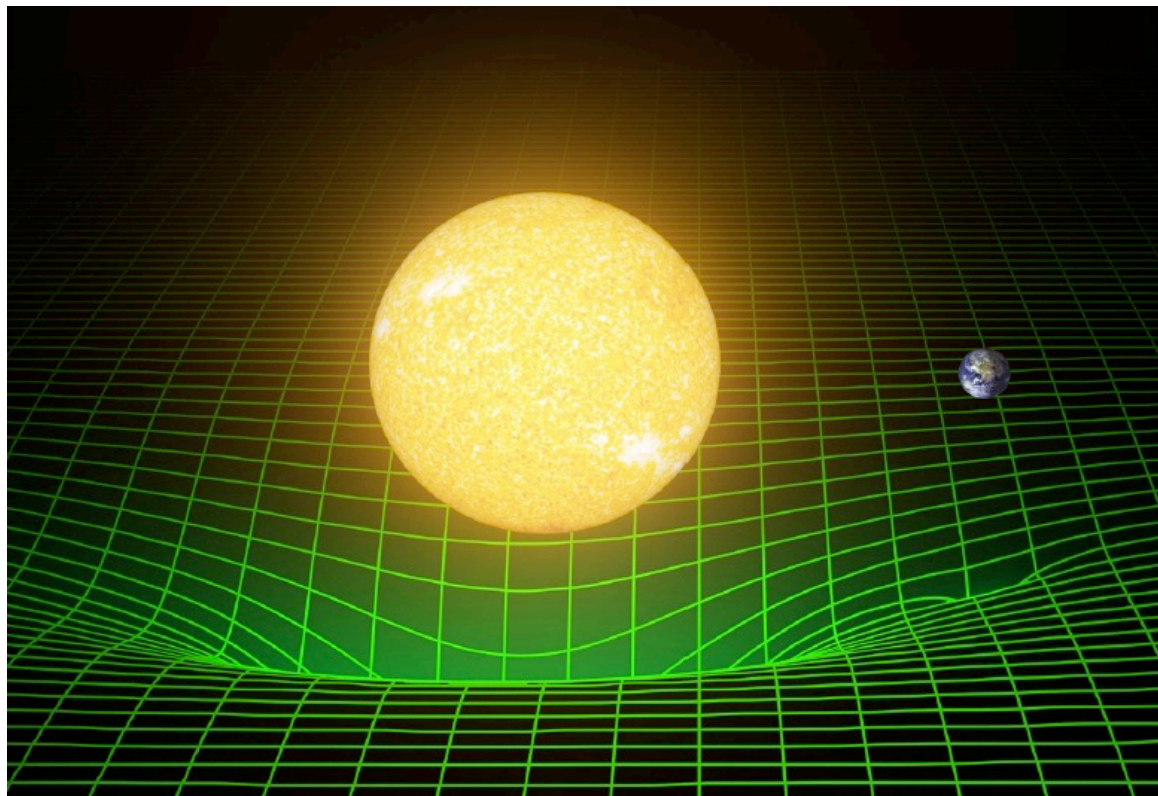

First observed during the solar eclipse of 1919 by Sir Arthur Eddington, when the Sun was silhouetted against the Hyades star cluster

Gravity and Space Time

- General relativity predicts the existence of black holes (Schwarzschild 1916)
- Another consequence: The existence of **gravitational waves**
 - predicted by Einstein in 1916, when he showed that accelerated massive objects radiate waves of distorted space

ON GRAVITATIONAL WAVES.

BY

A. EINSTEIN and N. ROSEN.

ABSTRACT.

The rigorous solution for cylindrical gravitational waves is given. For the convenience of the reader the theory of gravitational waves and their production, already known in principle, is given in the first part of this paper. After encountering relationships which cast doubt on the existence of *rigorous* solutions for undulatory gravitational fields, we investigate rigorously the case of cylindrical gravitational waves. It turns out that rigorous solutions exist and that the problem reduces to the usual cylindrical waves in euclidean space.

Publication in 1936

Gravitational Waves

- “Ripples” in space time
- travel at the speed of light, carrying information about their origin
- are produced by extremely violent processes in the Universe, such as collisions / mergers of black holes, massive compact stars, ...

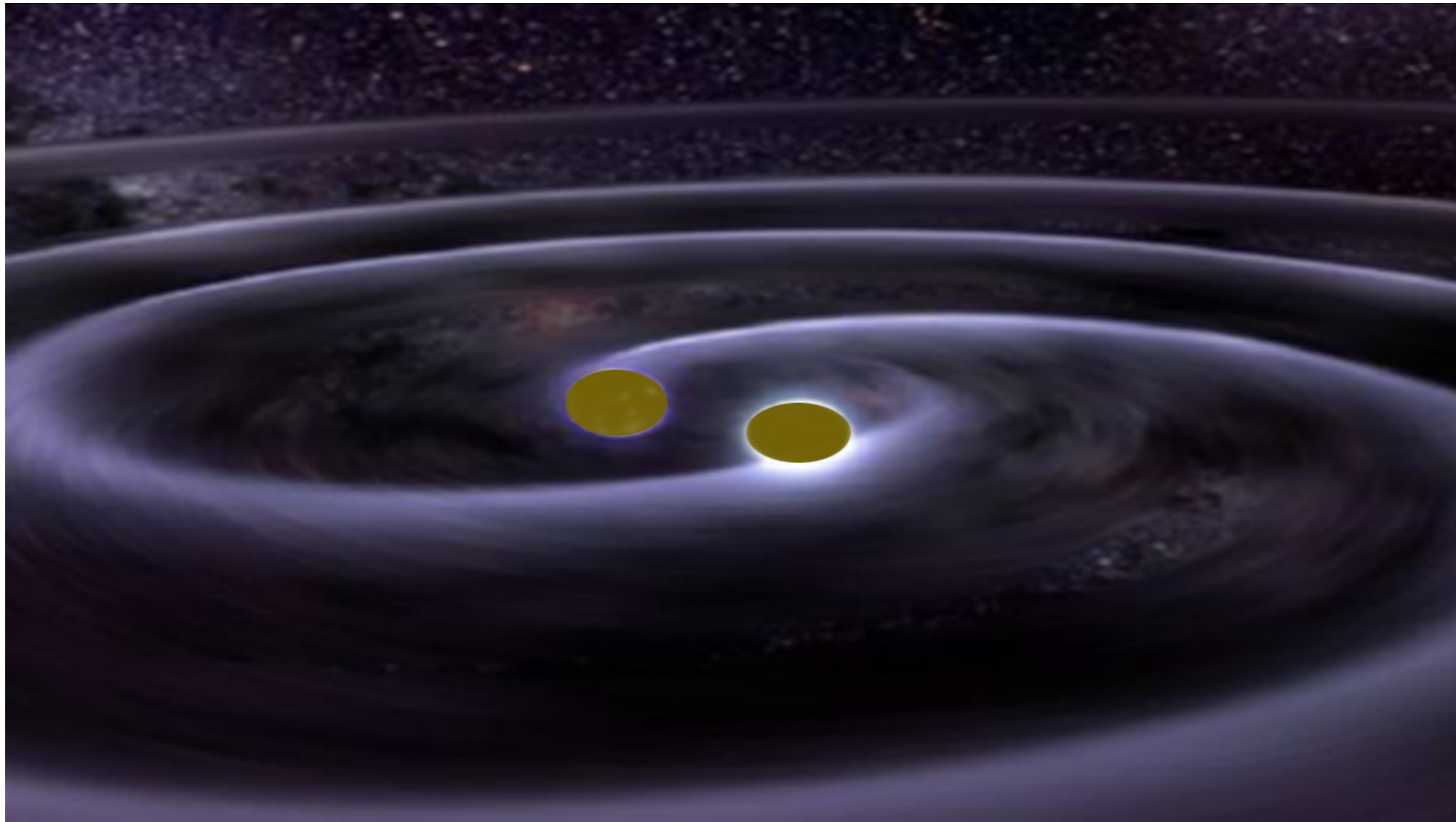

Aside: Indirect Detection

- Long-term observation of a binary pulsar shows the loss of orbital energy (decrease of distance, increase of revolution frequency) by the emission of gravitational waves

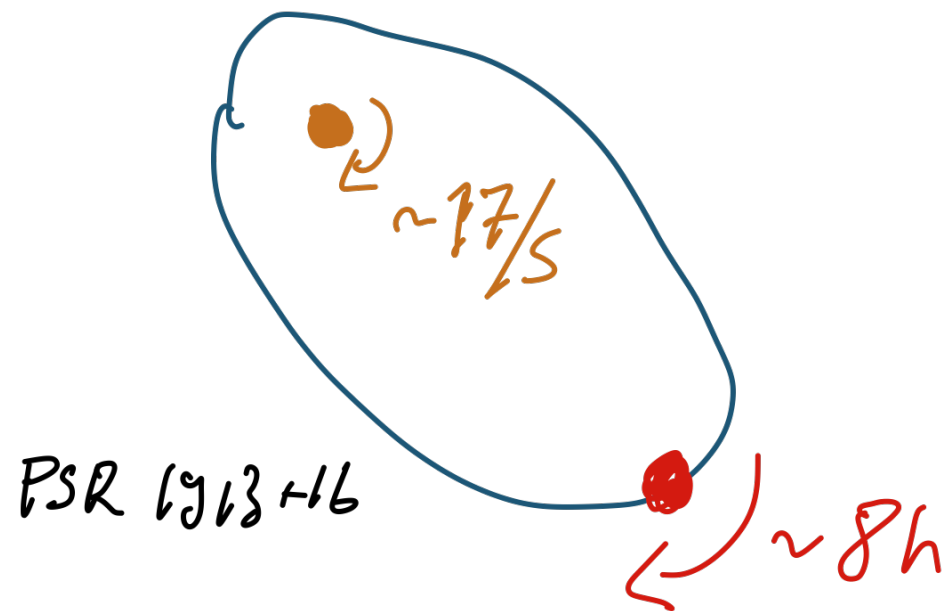

1993 Nobel Prize to Taylor and Hulse

Comparison between observations of the binary pulsar PSR1913+16, and the prediction of general relativity based on loss of orbital energy via gravitational waves

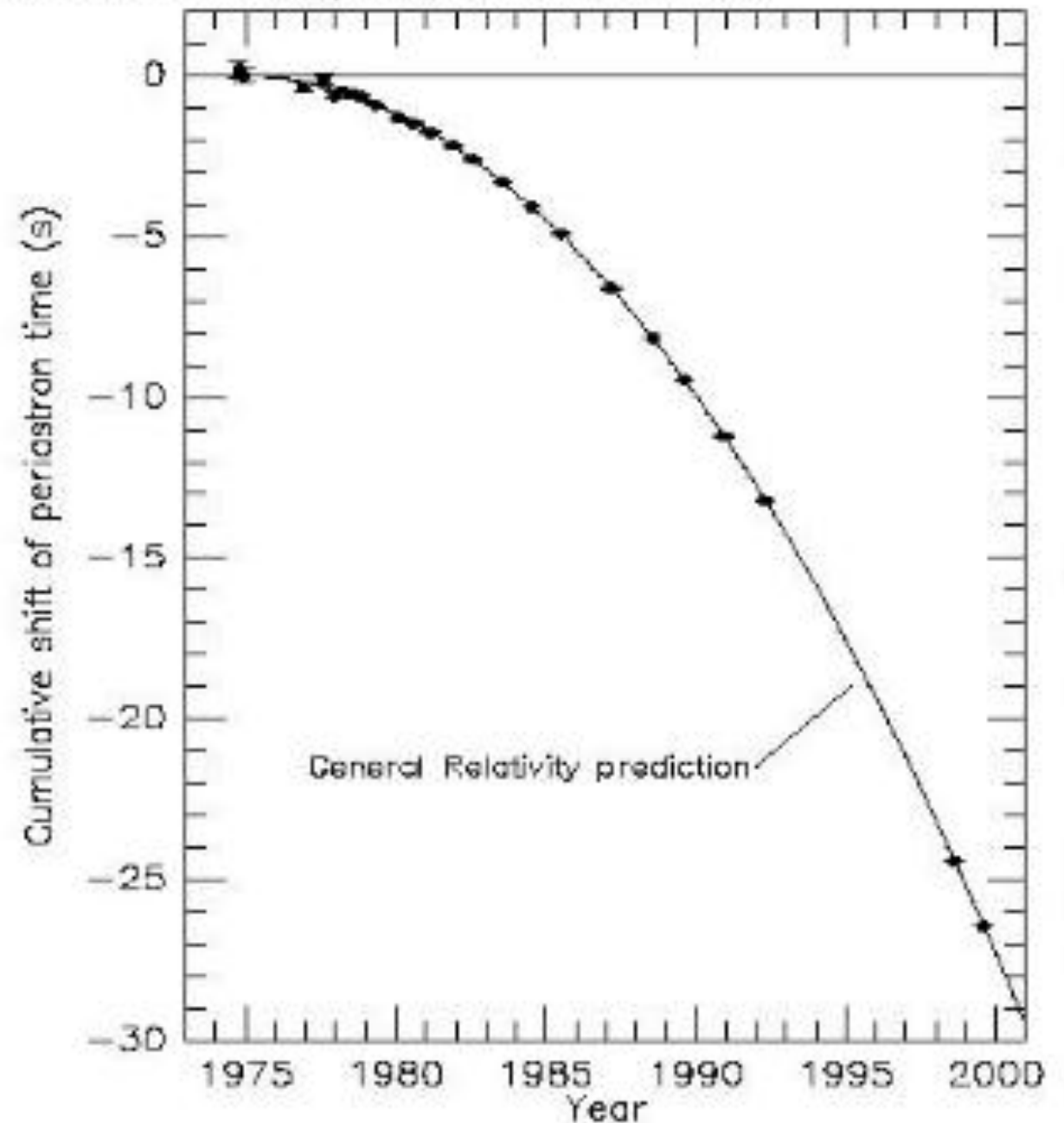

From J. H. Taylor and J. M. Weisberg, unpublished (2000)

Measuring Gravitational Waves

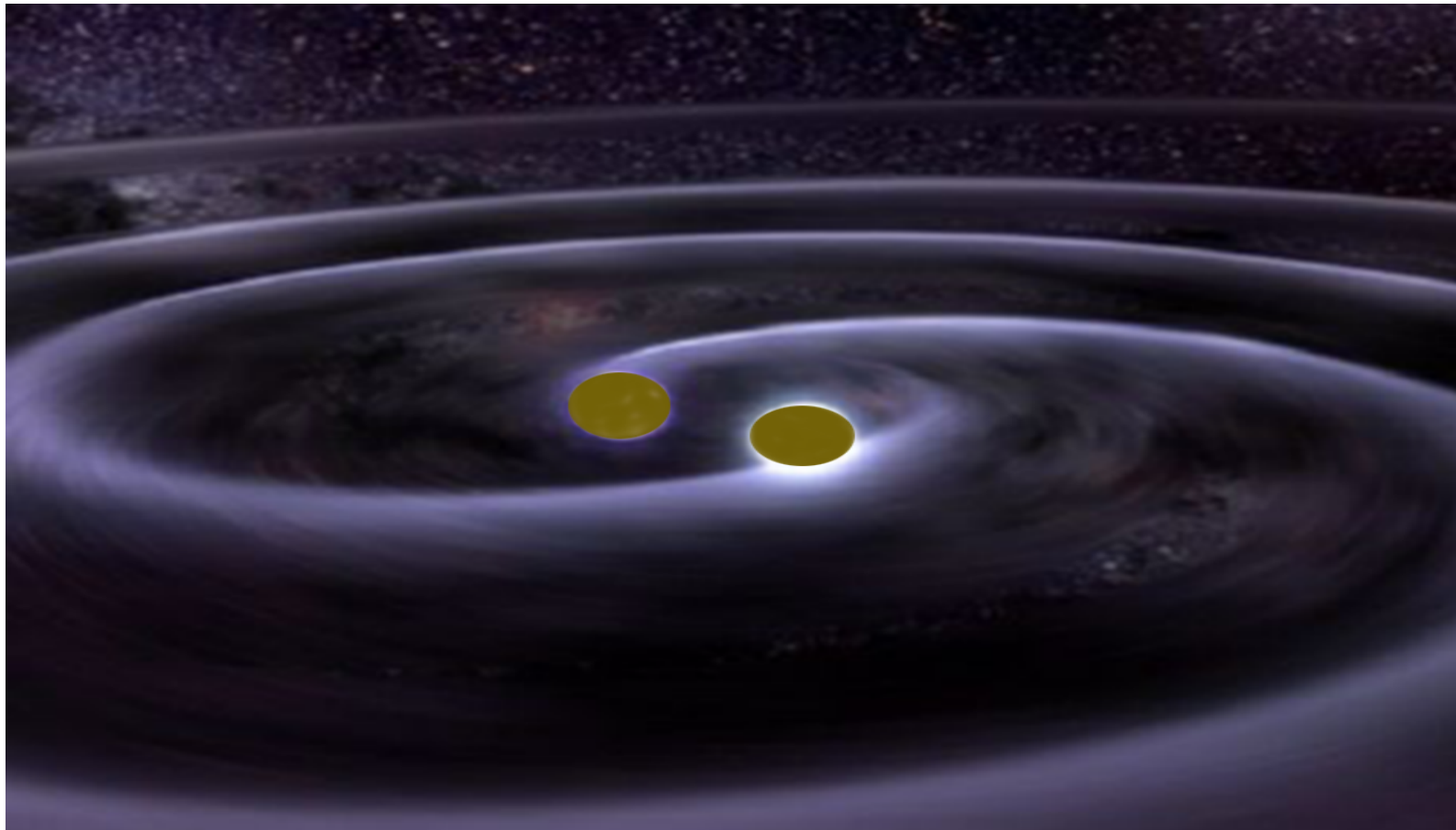

- The gravitational wave leads to changes in the spatial distance - but the effect is tiny!

Example:

- Consider ~30 solar mass binary merging Black Holes
- $M = 30 M_{\text{sun}}$
- $R = 100 \text{ km}$
- $f = 100 \text{ Hz}$
- $r = 3 \times 10^{24} \text{ m}$ (500 Mpc)

$$h = \Delta L / L \approx \frac{4\pi^2 GMR^2 f_{\text{orb}}^2}{c^4 r} \Rightarrow h \sim 10^{-21}$$

A length of 1 km will change by 10^{-18} m: Need a resolution of $\sim 10^{-19}$ m to make a measurement!

Measuring Gravitational Waves

- Since the 1960ies, searches have been performed with various techniques, including large test masses with piezo sensors, resonant bars and interferometric techniques have been used

State of the art: Interferometry

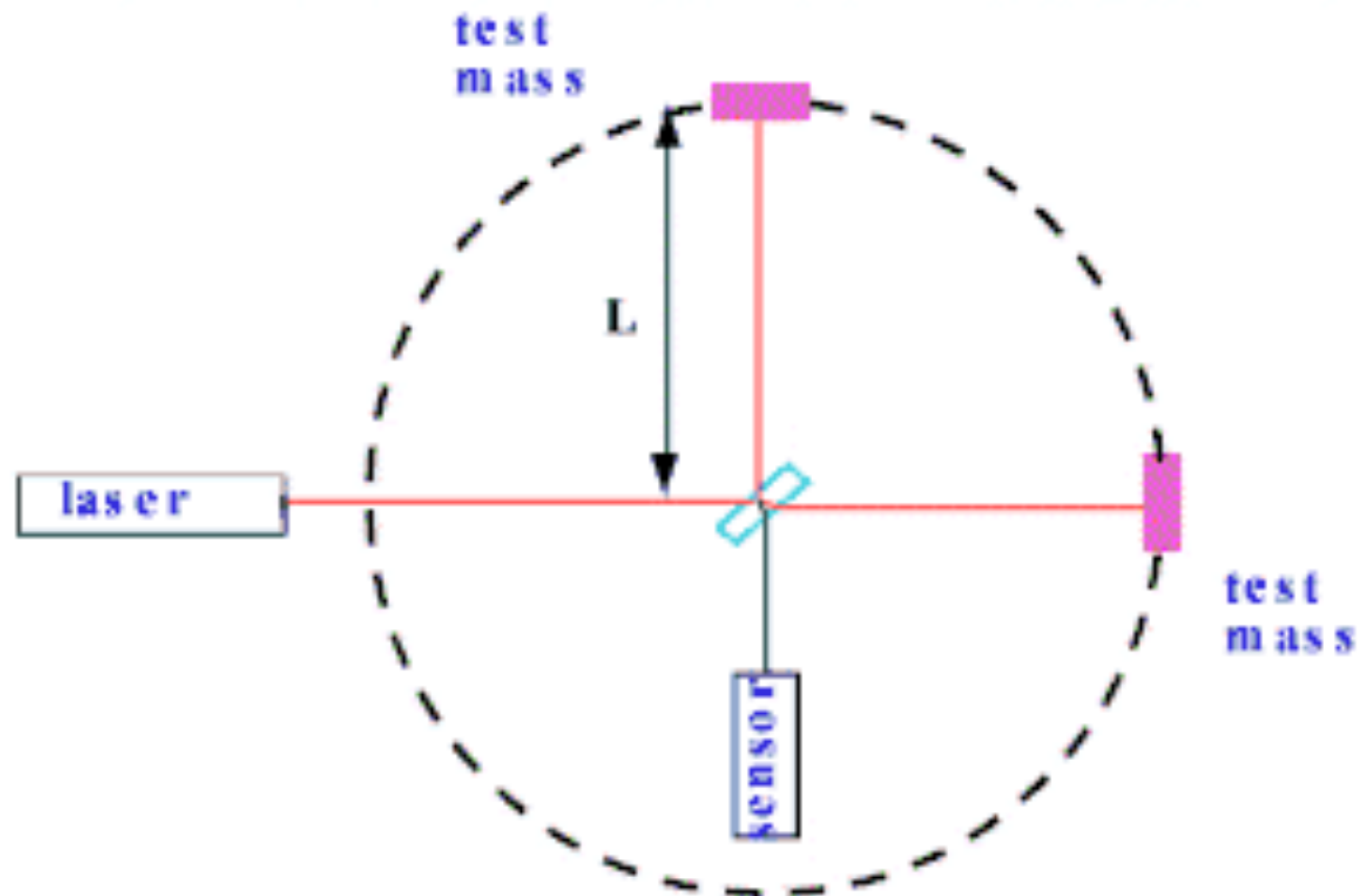

Aside: Local Historical Perspective

- The MPI for Physics (back then: MPI for Physics and Astrophysics) was among the pioneers of gravitational wave searches

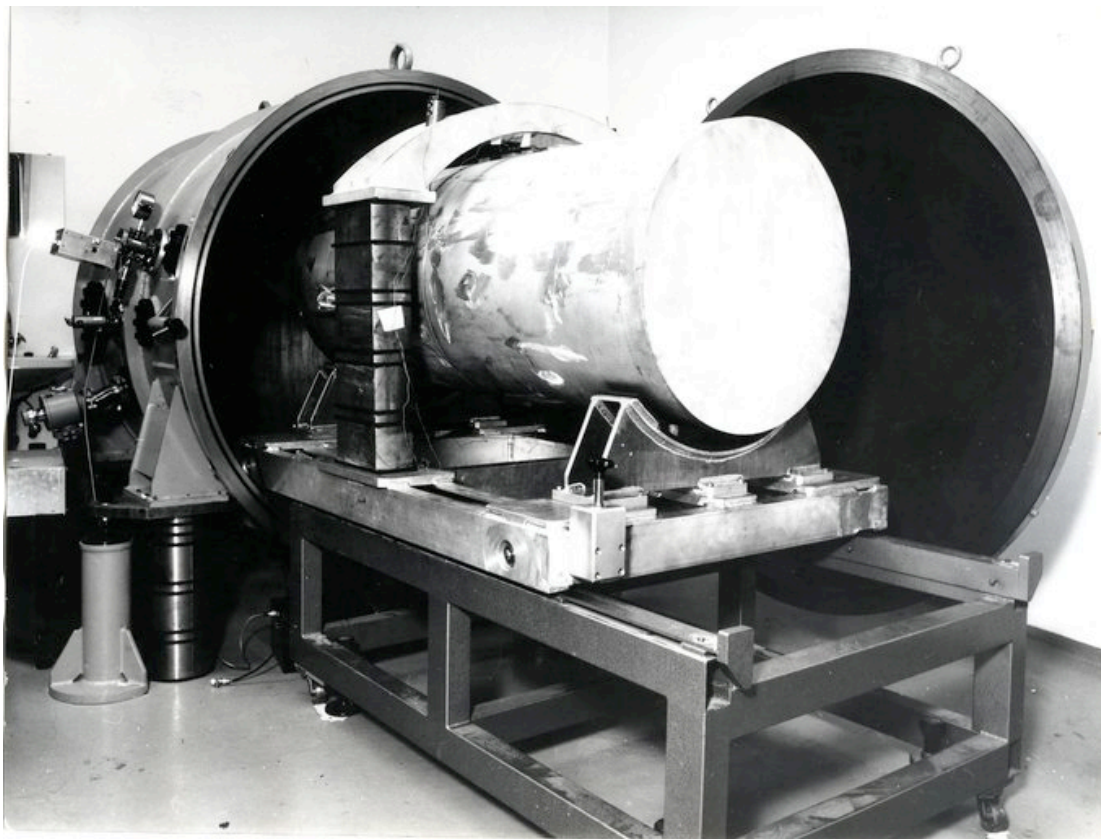

Resonator experiments in the early 70ies

First interferometer experiments in late 70ies, first with 3 m arm length, then 30 m on the Garching Campus of the MPI



GW Measurement with Interferometer: Principle

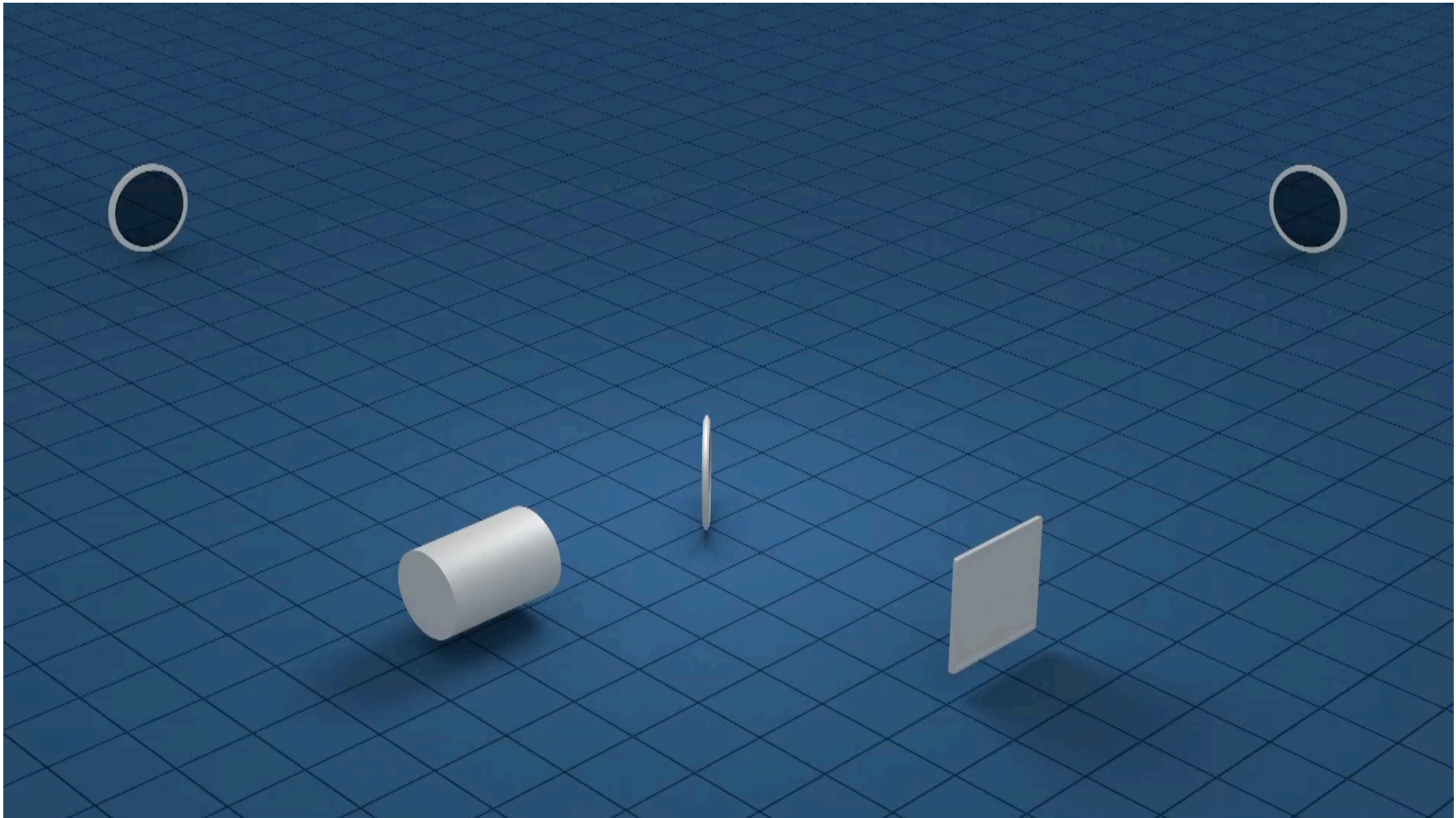

LIGO

- **Laser Interferometer Gravitational-Wave Observatory**

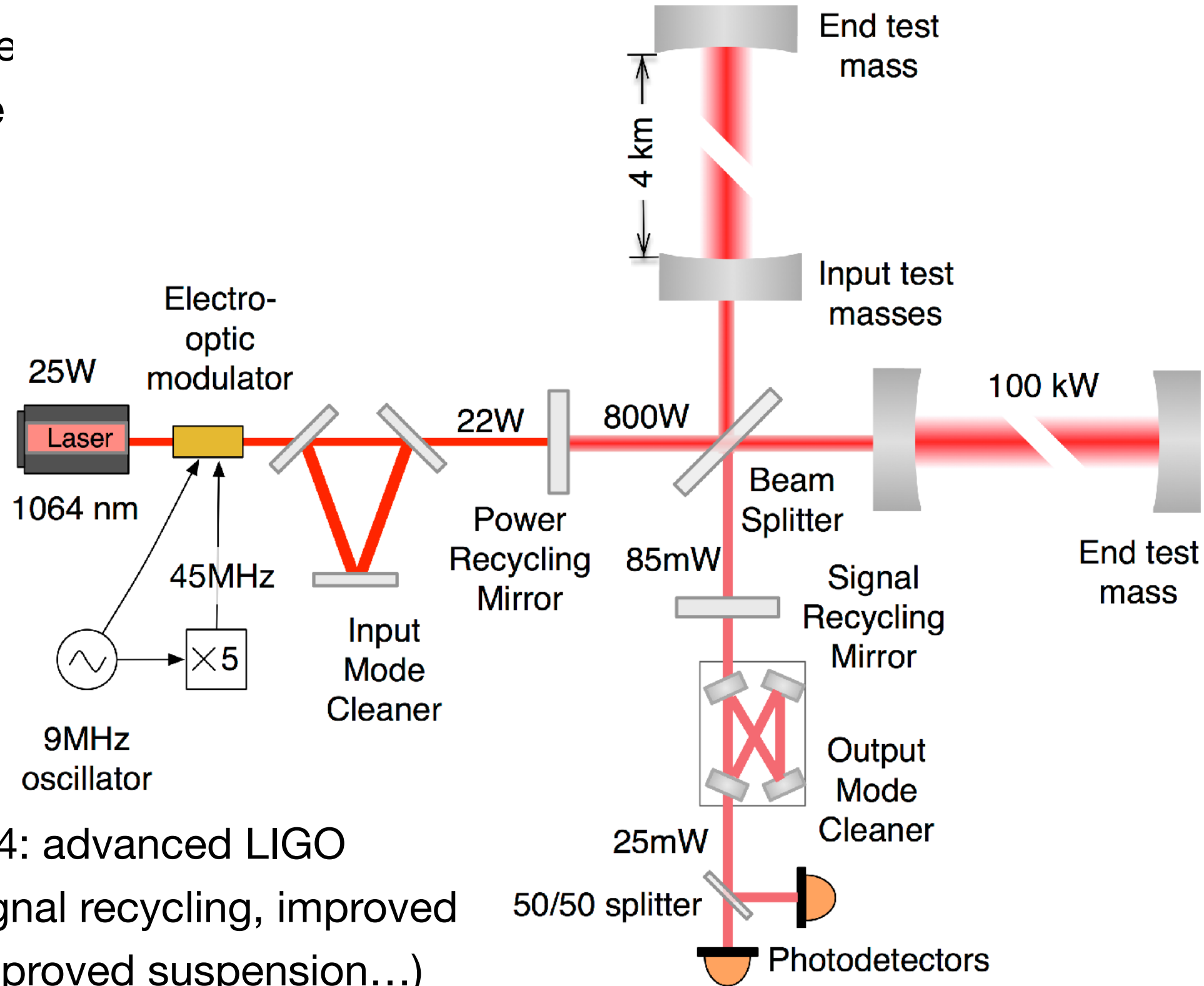

- operating since 2014: advanced LIGO (power recycling, signal recycling, improved optical elements, improved suspension...)

LIGO: Main Parameters

Table 1. Main parameters of the Advanced LIGO interferometers. PRC: power recycling cavity; SRC: signal recycling cavity.

Parameter	Value
Arm cavity length	3994.5 m
Arm cavity finesse	450
Laser type and wavelength	Nd:YAG, $\lambda = 1064$ nm
Input power, at PRM	up to 125 W
Beam polarization	linear, horizontal
Test mass material	Fused silica
Test mass size & mass	34cm diam. x 20cm, 40 kg
Beam radius ($1/e^2$), ITM / ETM	5.3 cm / 6.2 cm
Radius of curvature, ITM / ETM	1934 m / 2245 m
Input mode cleaner length & finesse	32.9 m (round trip), 500
Recycling cavity lengths, PRC / SRC	57.6 m / 56.0 m

LIGO

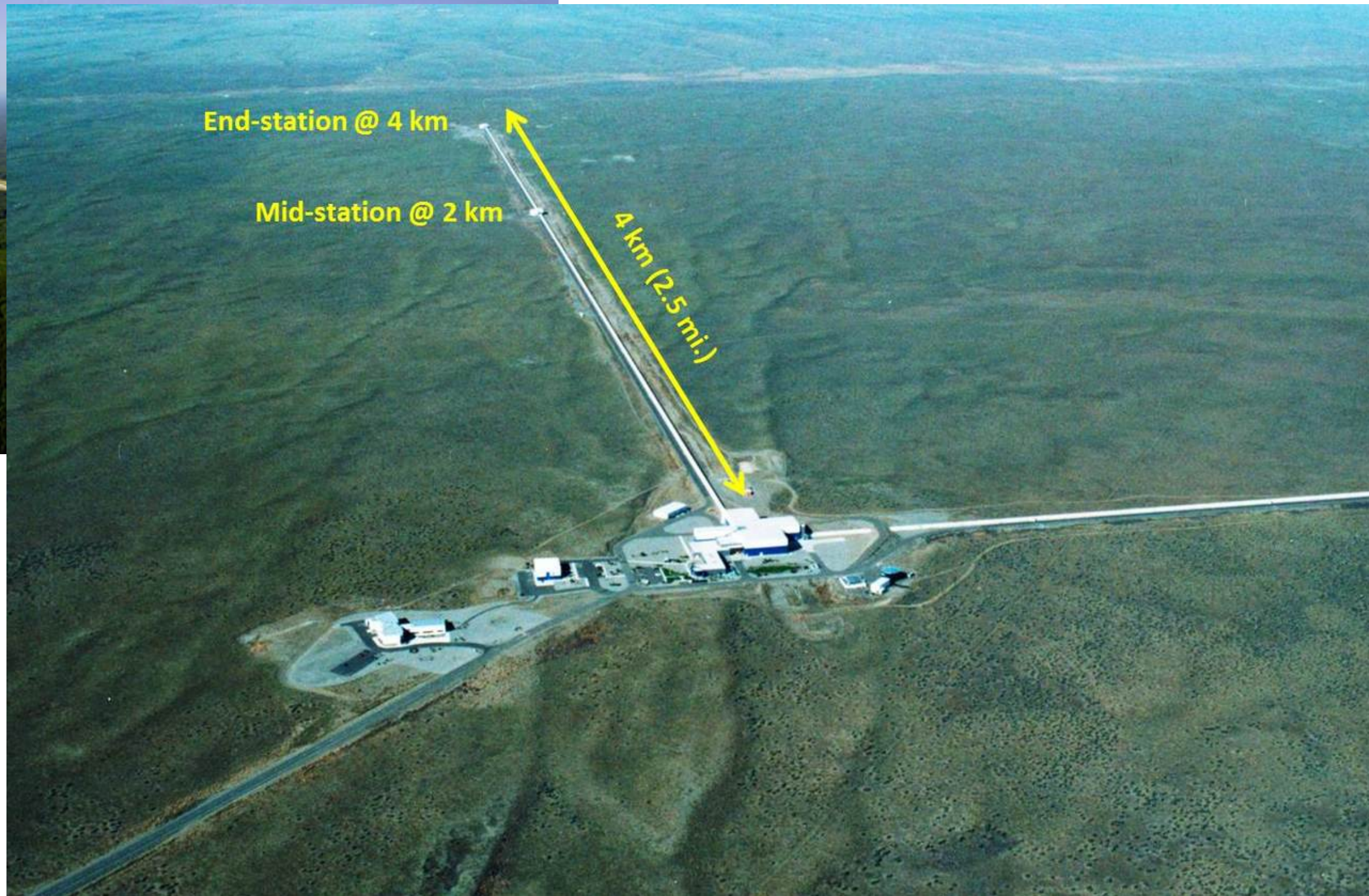

LIGO: 2 Sites

- 2 Sites to gain directional information

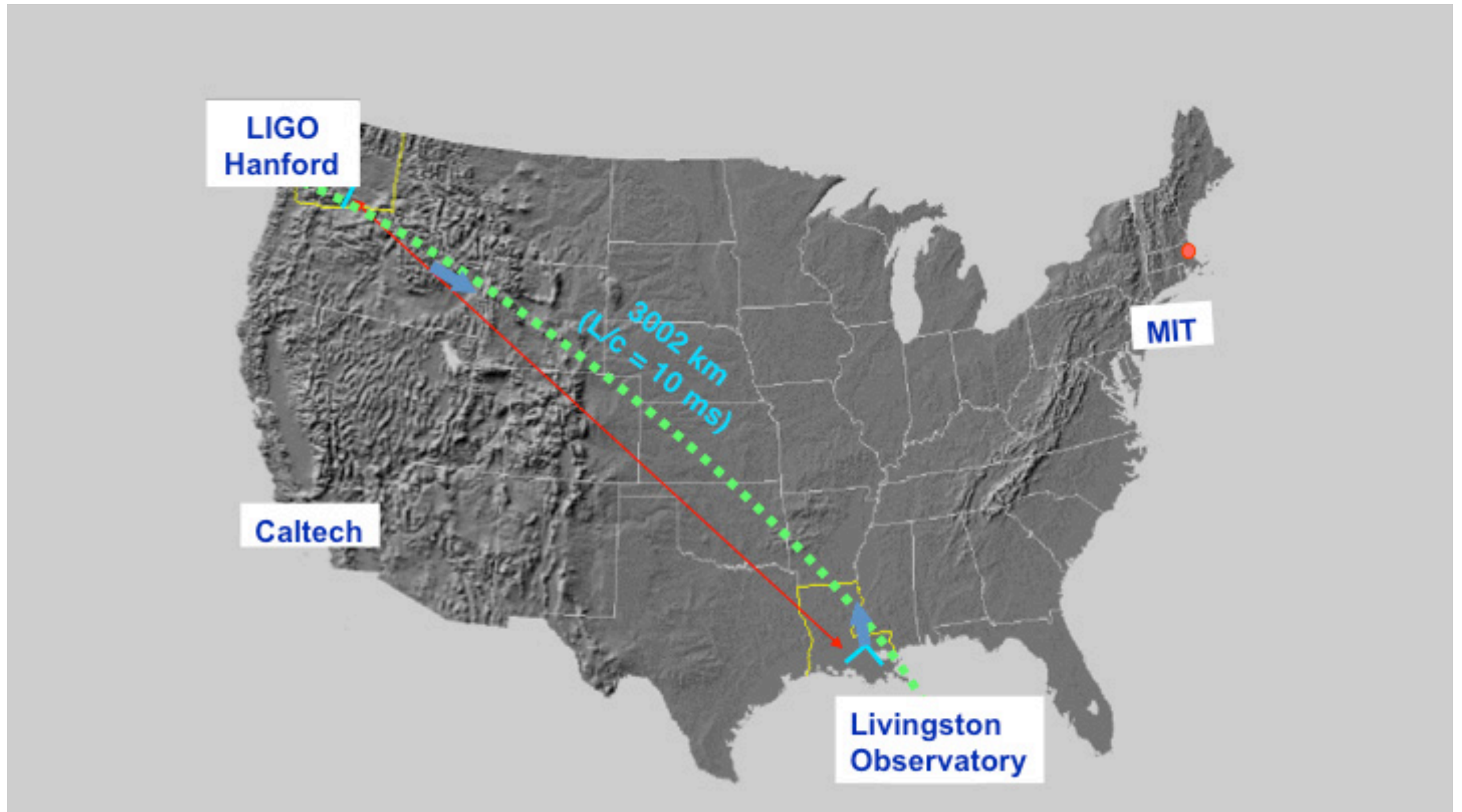

Measurements: Limitations

- The key: controlling noise

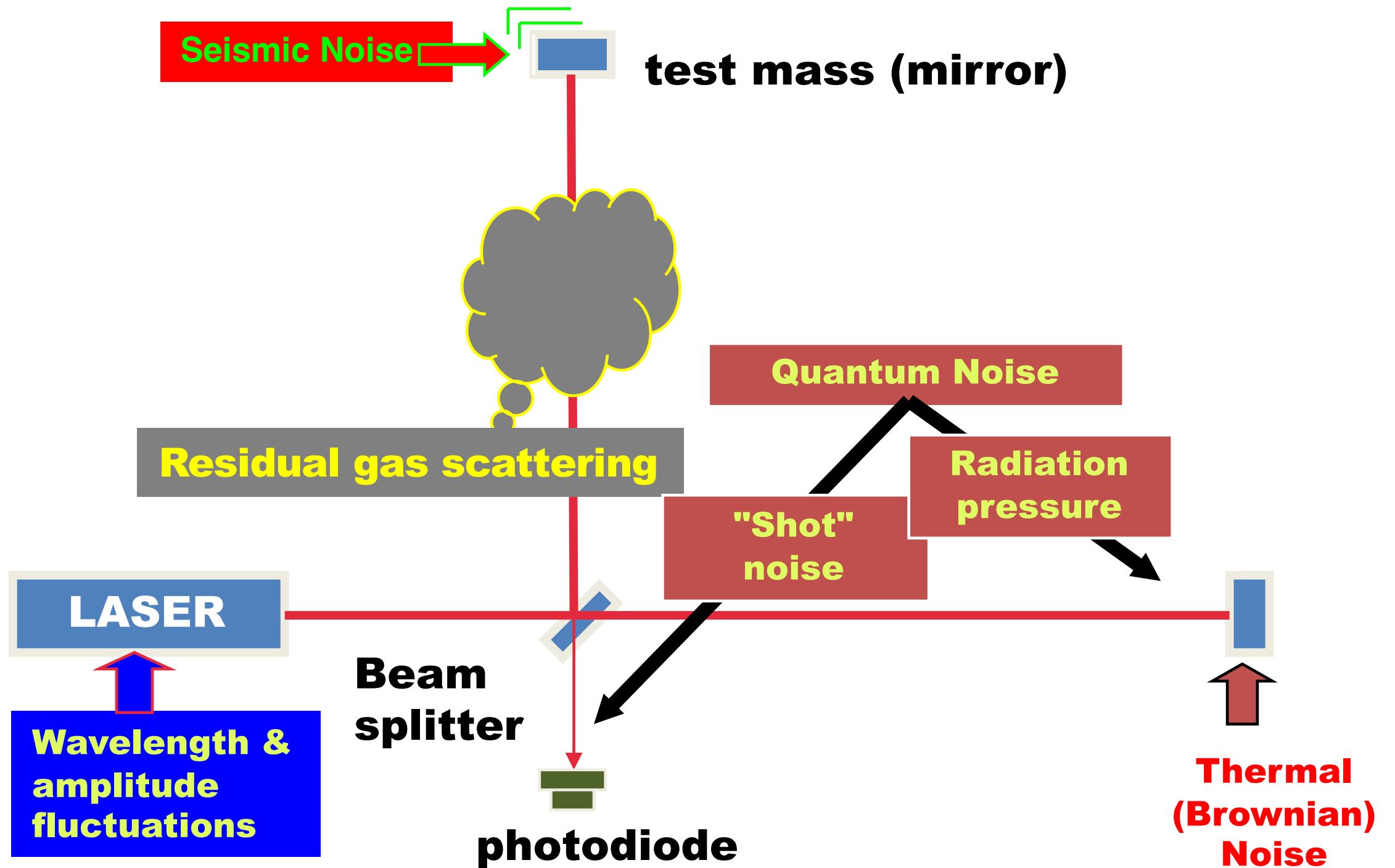

Measurements: Examples for Noise Sources

- **Seismic noise**, due to the motion of the mirrors from ground vibrations, earthquakes, wind, ocean waves, and human activities such as vehicle traffic.
- **Thermal noise**, from the microscopic fluctuations of the individual atoms in the mirrors and their suspensions.
- **Quantum noise**, due to the discrete nature of light (composed of photons) and the statistical uncertainty from the "**photon counting**" that is performed by the photodetectors.
- **Gas noise**, from the interactions of the residual gas particles in the vacuum enclosure with the mirrors and the laser light.
- **Charging noise**, from the interaction of static electric charges on the glass mirrors with the metal of the vacuum enclosures and the mirror supports.
- **Laser noises**, for example small variations in the laser intensity and frequency.
- **Auxiliary degree-of-freedom noise**, due to the control of the position and alignment of the various mirrors in the detectors, and the slight cross-coupling between those mirrors and the measurement of the gravitational wave signal.
- **Oscillator noise**, generated by the **radiofrequency modulation** of the laser light, which is necessary for the control of the interferometer.
- **Beam jitter**, or slight variations in the position and angle of the laser beam in the detector, which can generate noise if they misalign the laser beam with respect to the optical cavities.
- **Scattered light**, generated by tiny imperfections in the mirrors of the interferometers, which can redirect a small fraction of the laser light towards the walls or other components of the instruments. If this light recombines with the main beam it will generate a spurious signal in the readout photodetectors.
- And finally, **electronics noise**, which is generated by the analog and digital electronics that are used to measure the signal itself.

LIGO Sensitivity for first Run

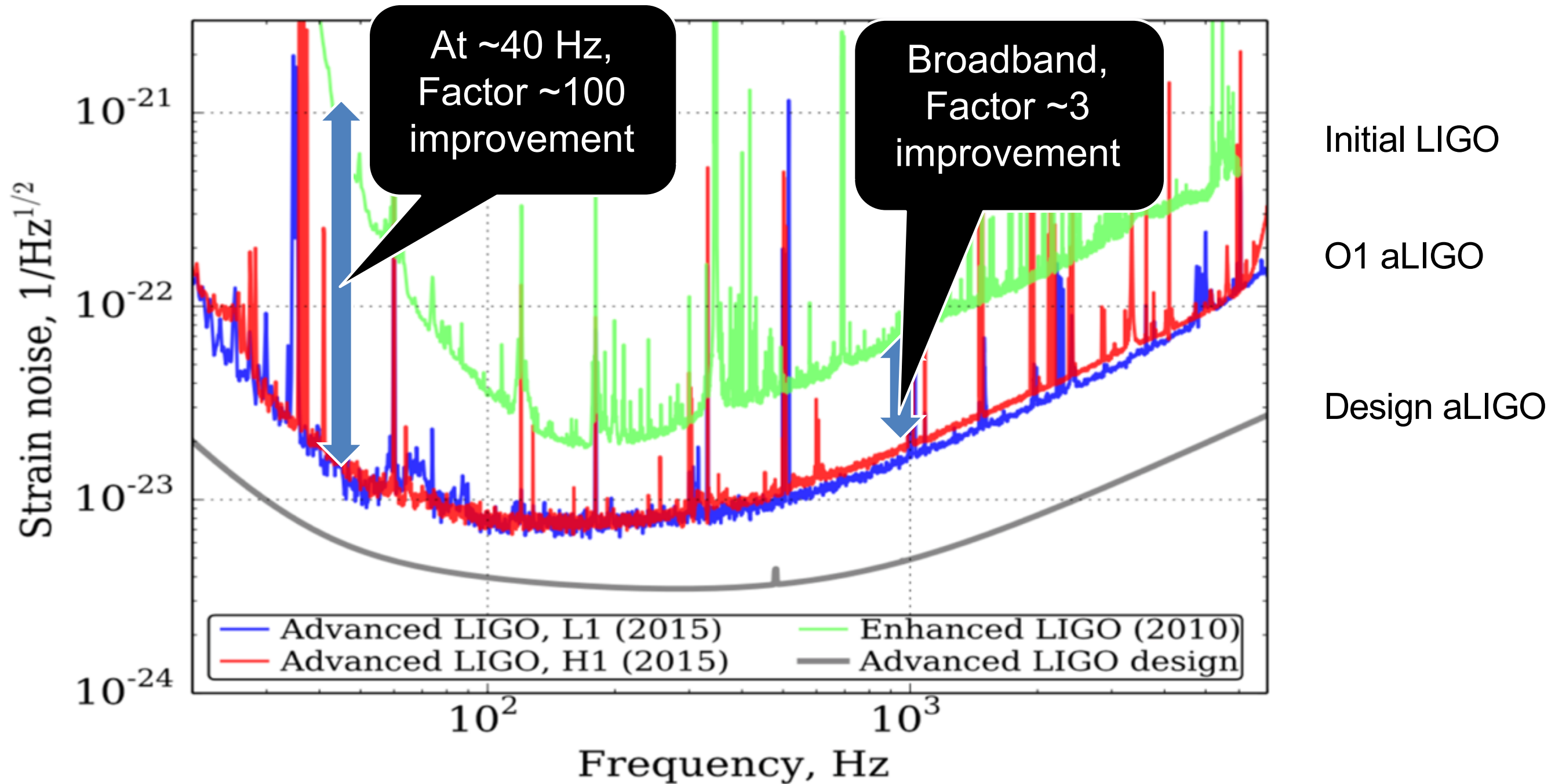

LIGO Noise Level

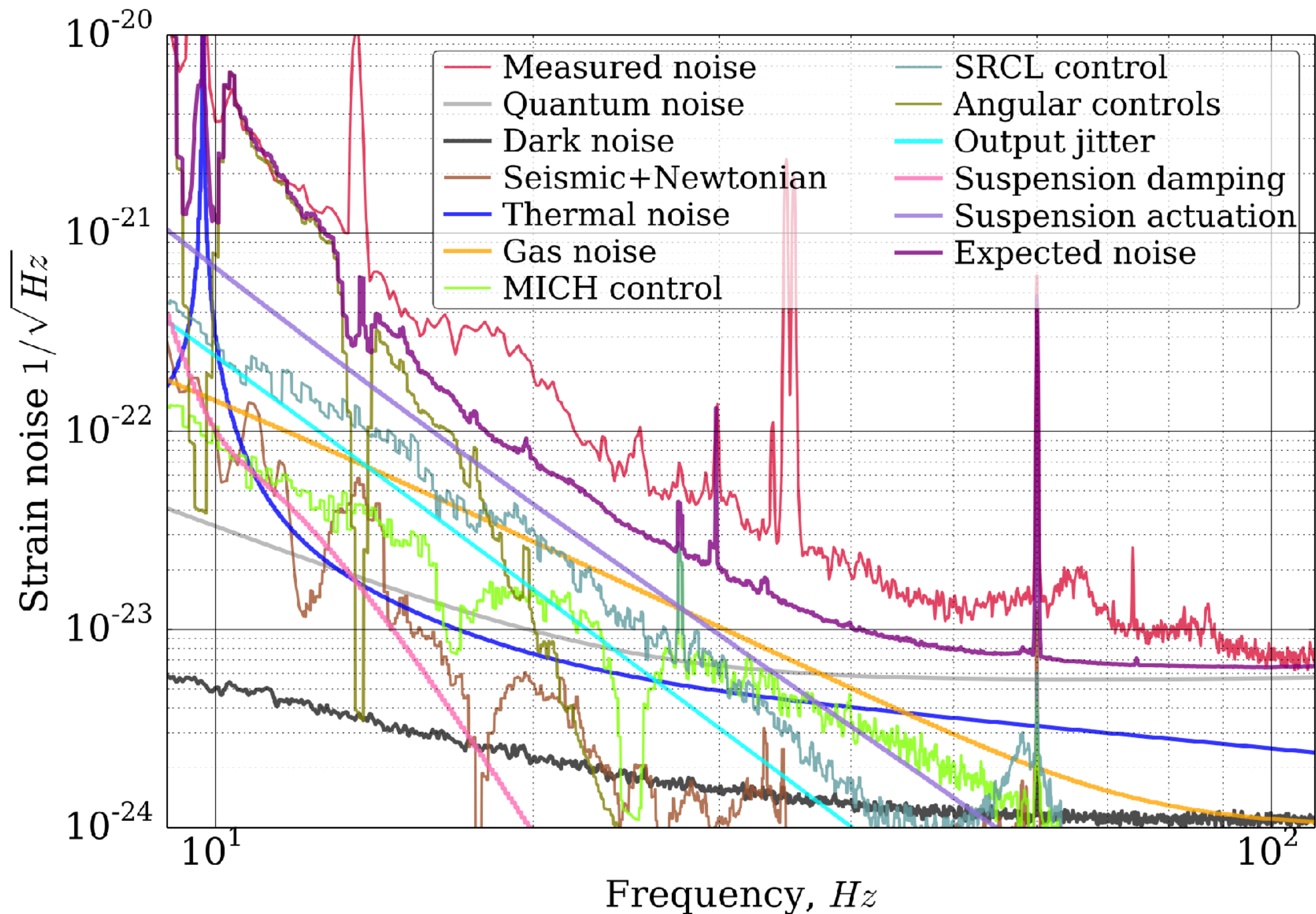

LIGO Tech: Nd:YAG Laser

- A 200 W laser, contributed by MPI for Gravitational Physics

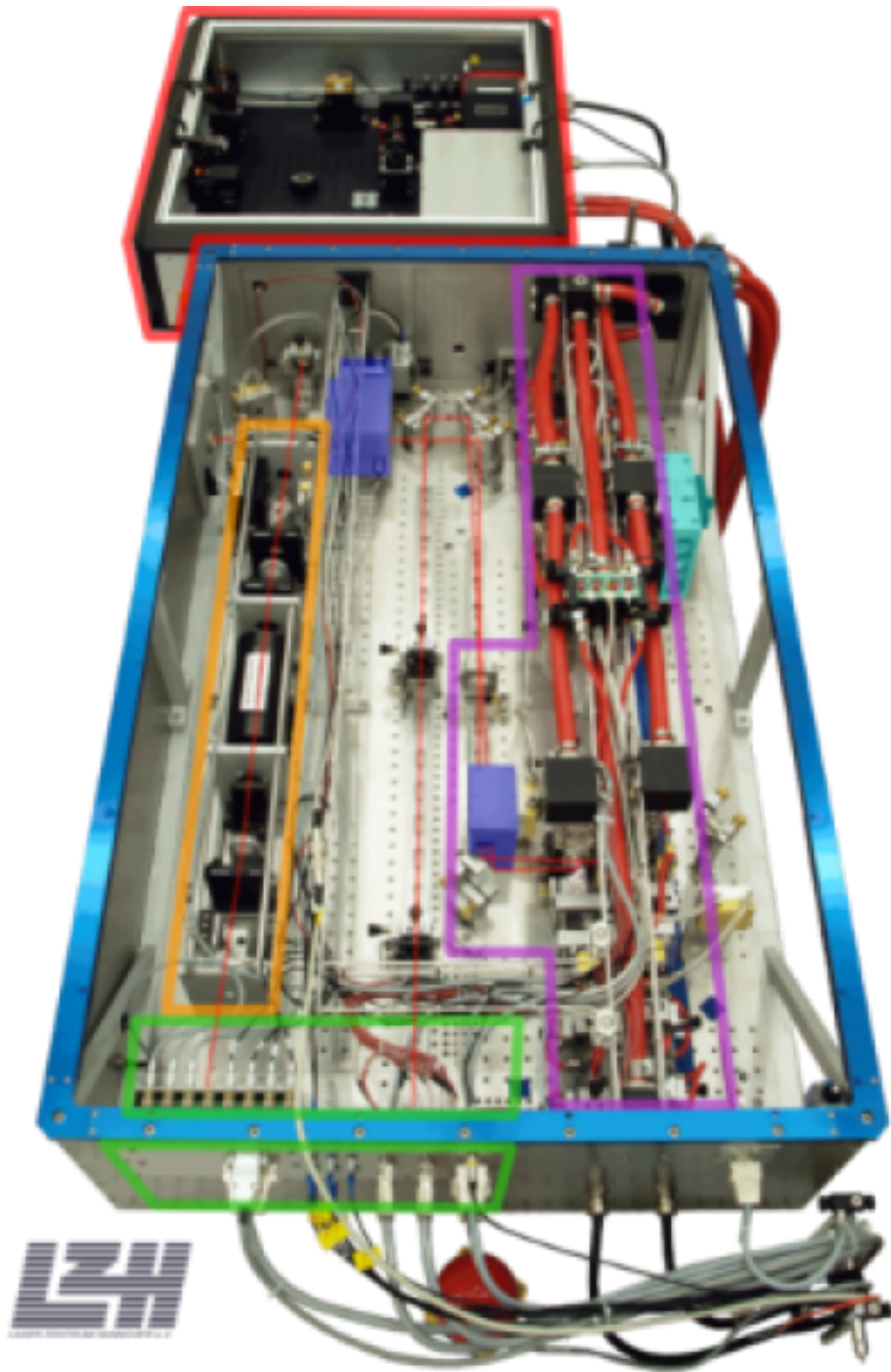

- **Stabilized in power and frequency**
- **Uses a monolithic master oscillator followed by injection-locked rod amplifier**

LIGO Tech: Mirror & Test Mass

- Mechanical requirements: bulk and coating thermal noise, high resonant frequency
- Optical requirements: figure, scatter, homogeneity, bulk and coating absorption

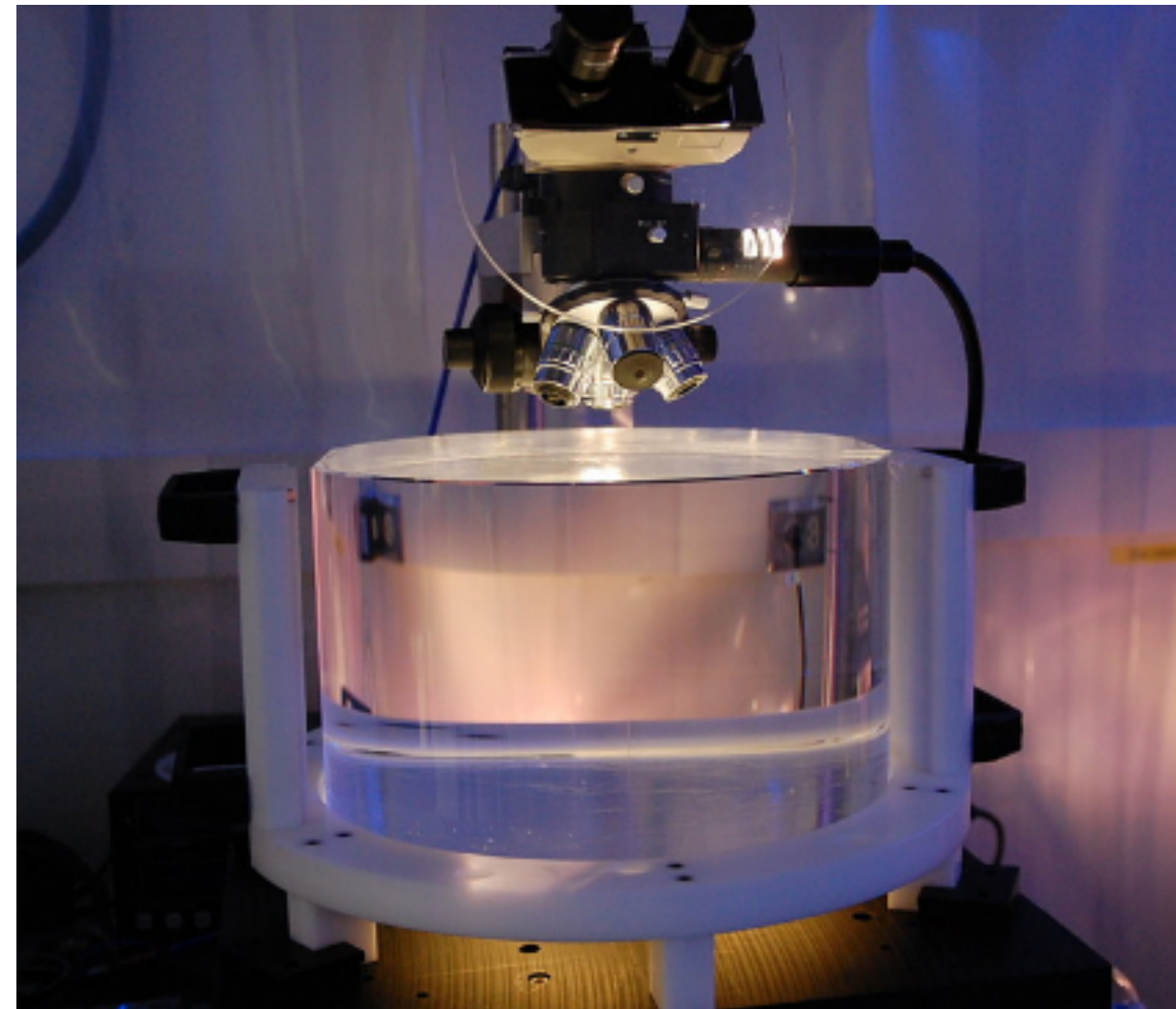
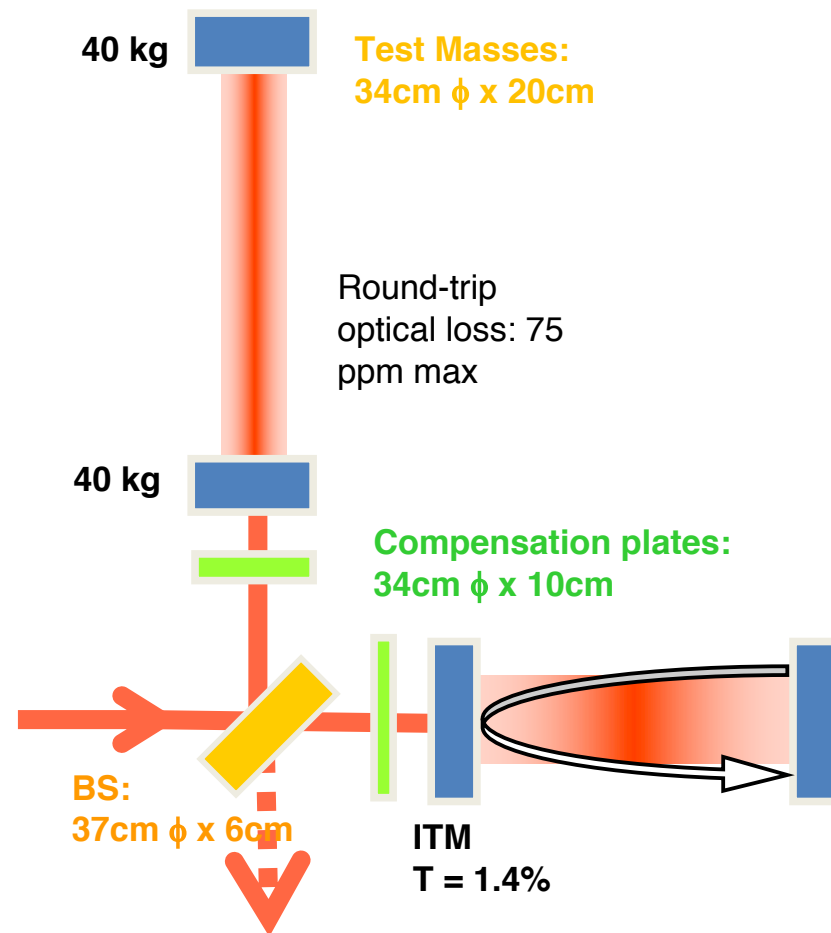

LIGO Tech: Test Mass Suspension

- Quadruple pendulum suspension

**Optics Table Interface
(Seismic Isolation System)**

Damping Controls

**Hierarchical Global
Controls**

**Electrostatic
Actuation**

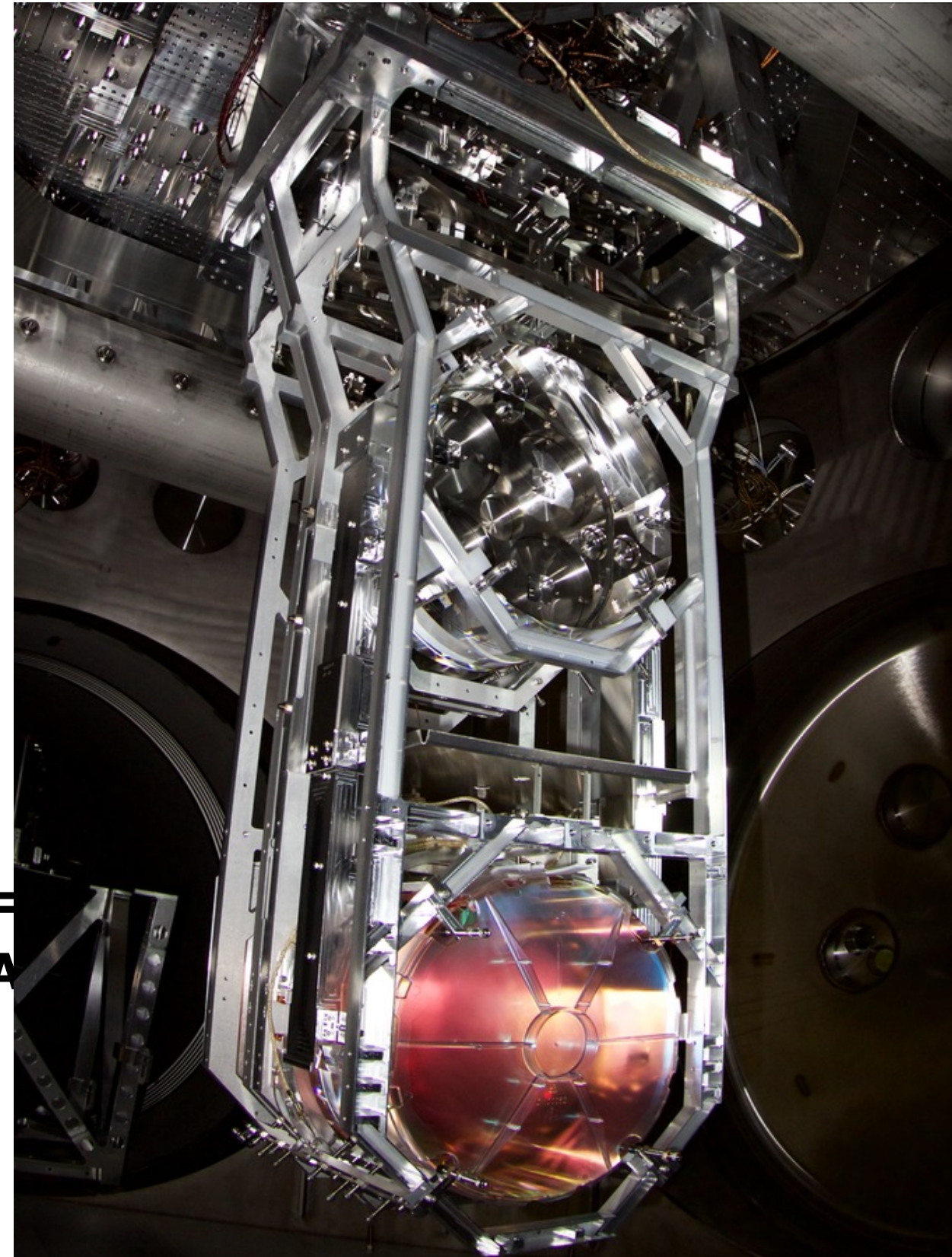
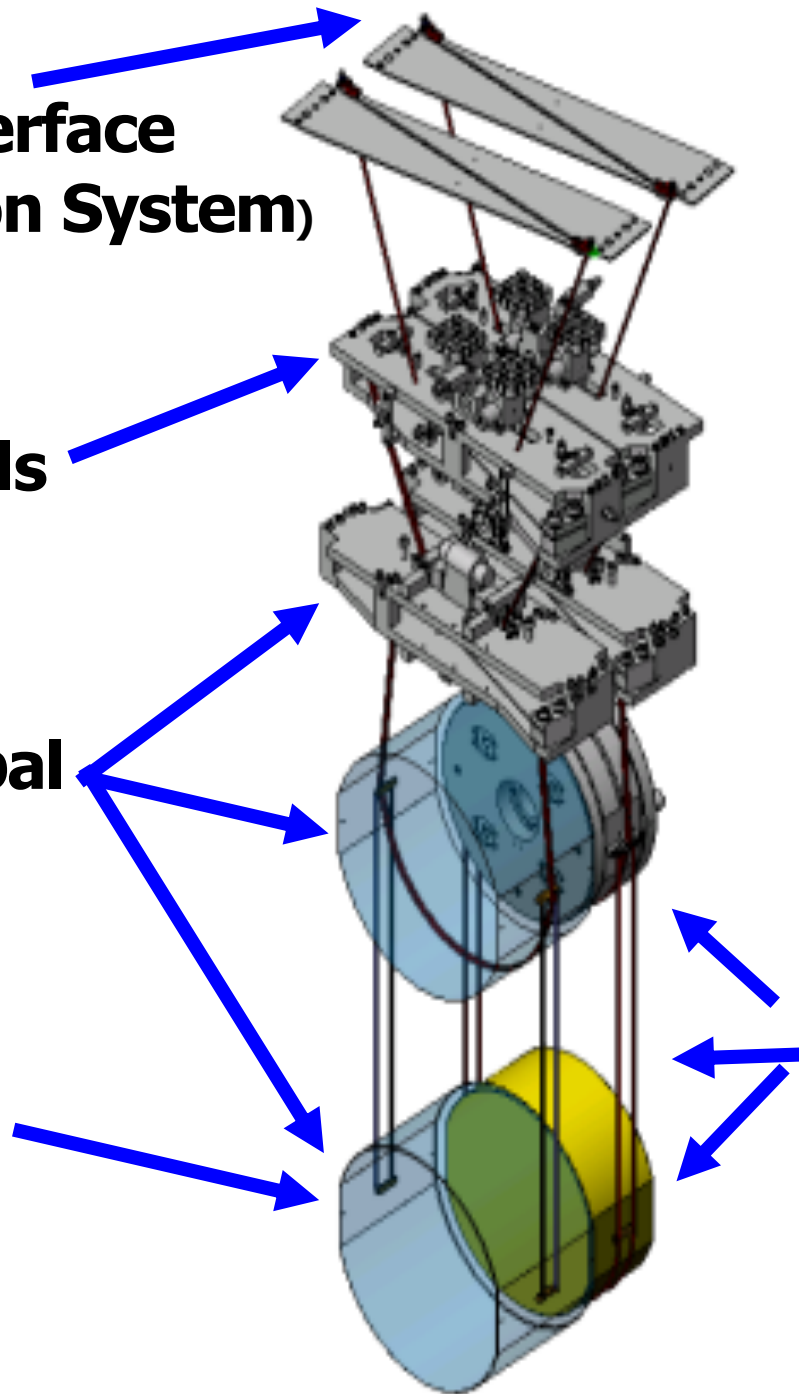

LIGO Tech: Seismic Isolation

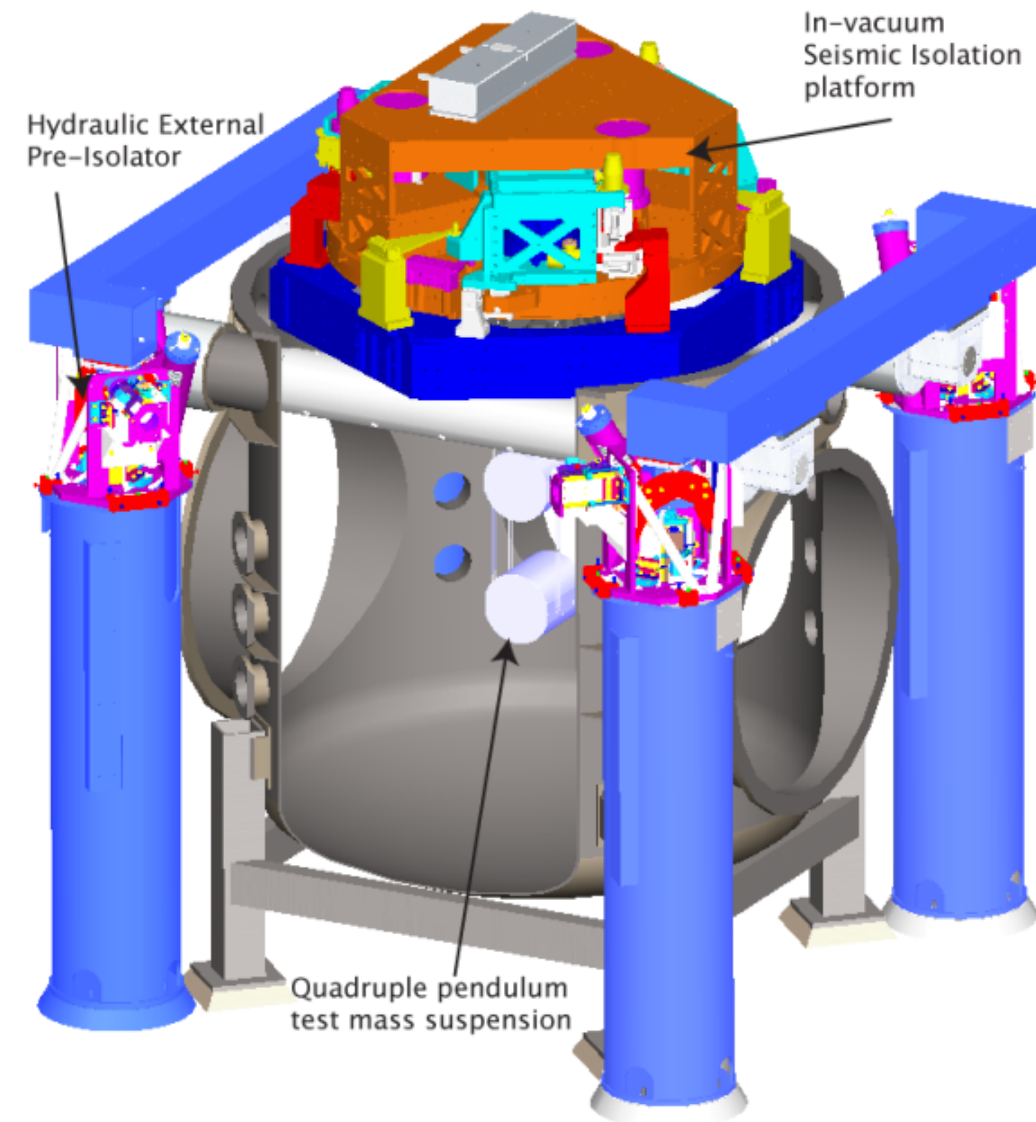
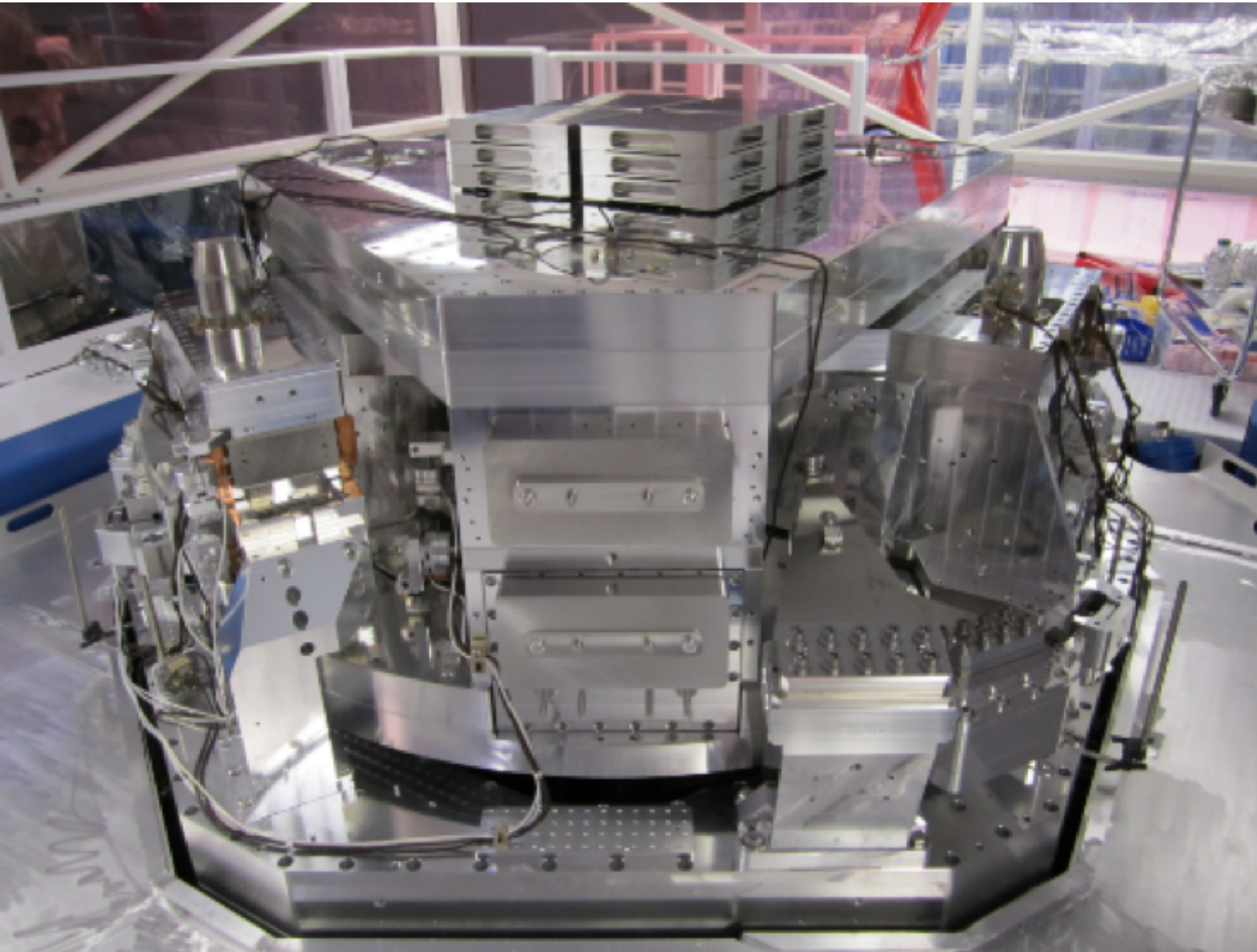

LIGO Observations: GW150914

Data bandpass filtered between 35 Hz and 350 Hz

Time difference 6.9 ms with Livingston first

Second row – calculated GW strain using Numerical Relativity Waveforms for quoted parameters compared to reconstructed waveforms (Shaded)

Third Row –residuals

bottom row – time frequency plot showing frequency increases with time (chirp)

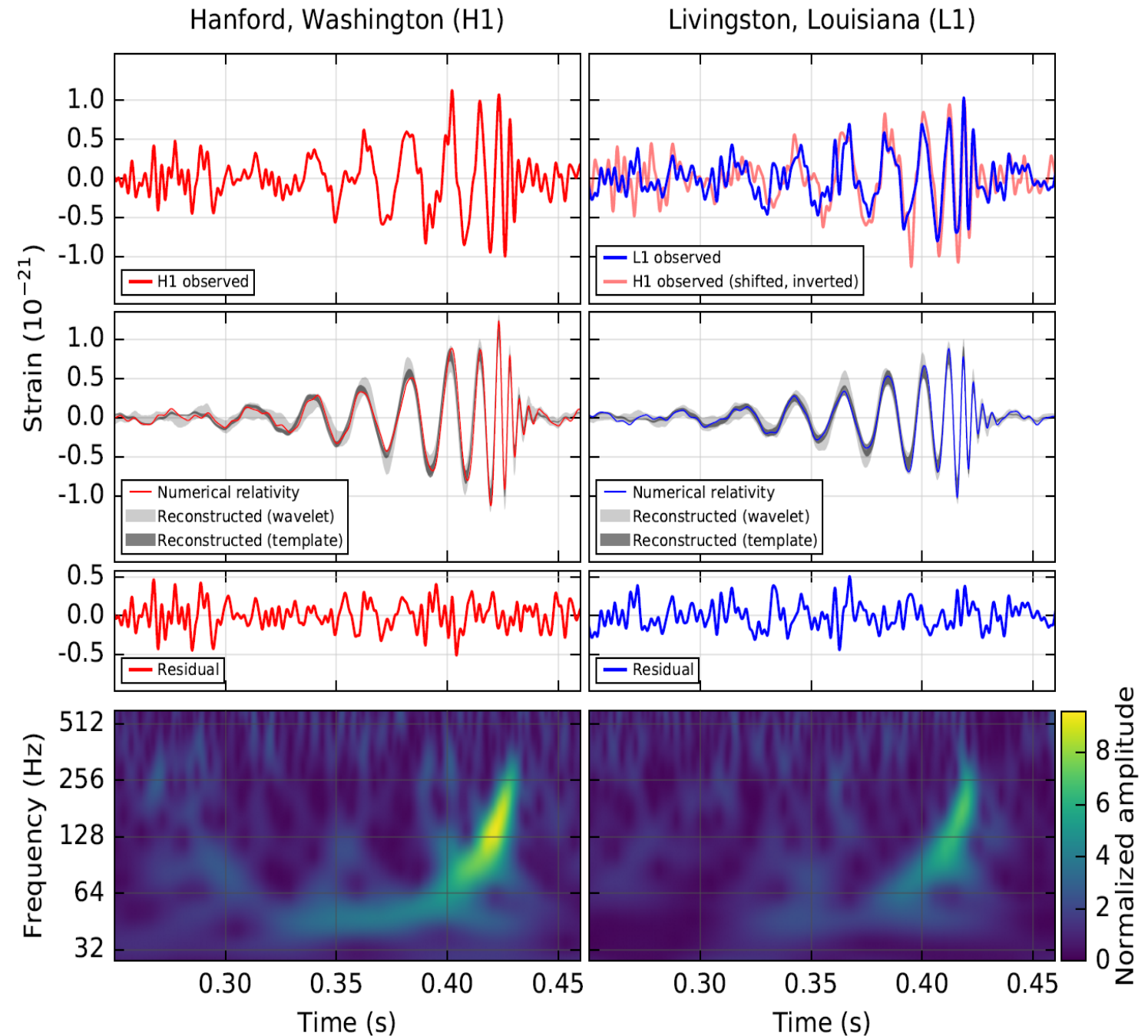

LIGO Observations: GW150914

- Interpreted signal:
Merger of two black holes

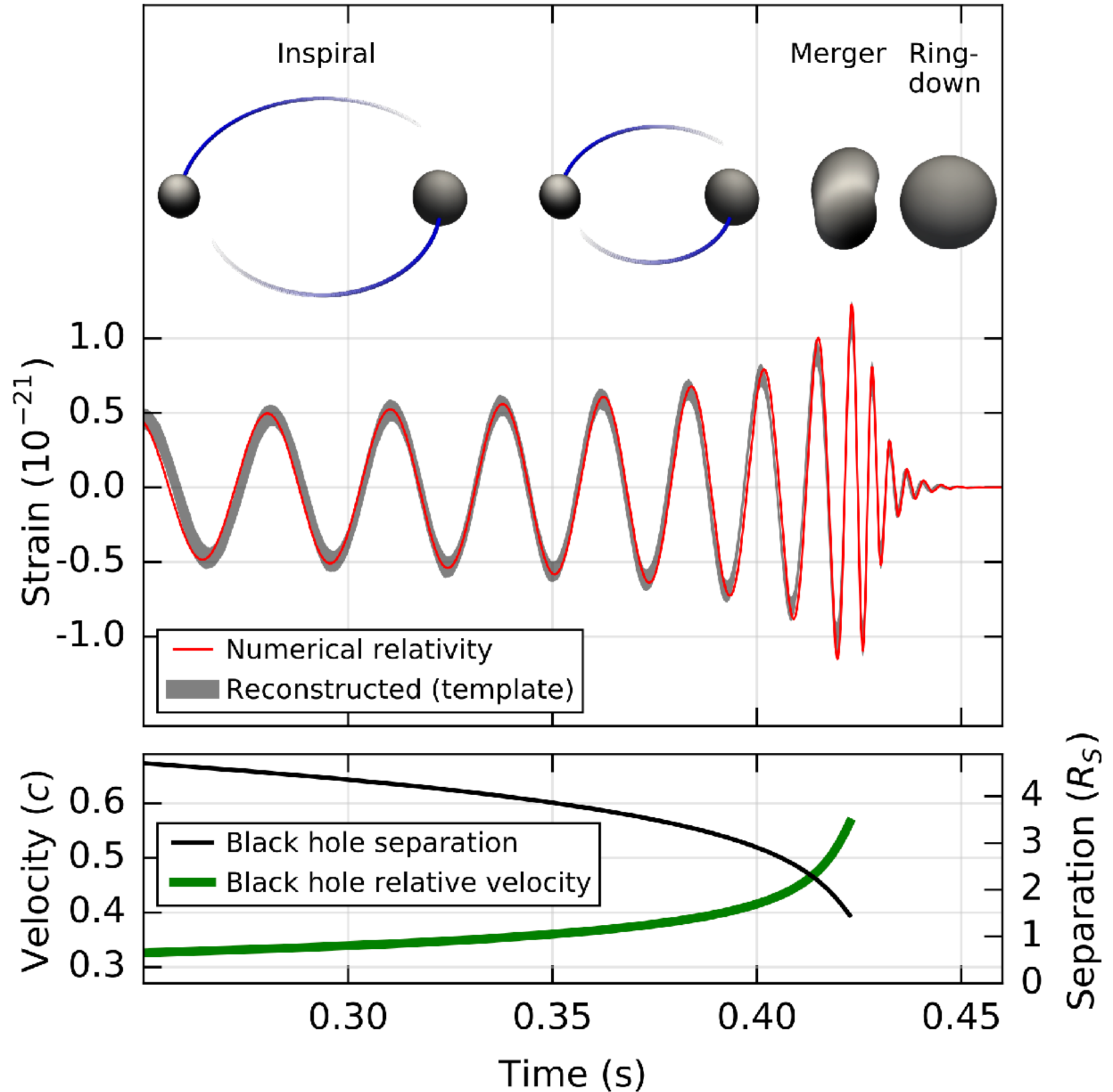

LIGO Observations: GW150914

- Use numerical simulations fits of black hole merger to determine parameters; determine total energy radiated in gravitational waves is $3.0 \pm 0.5 M_{\odot} c^2$. The system reached a peak $\sim 3.6 \times 10^{56}$ ergs, and the spin of the final black hole < 0.7 (not maximal spin)

Primary black hole mass	$36^{+5}_{-4} M_{\odot}$
Secondary black hole mass	$29^{+4}_{-4} M_{\odot}$
Final black hole mass	$62^{+4}_{-4} M_{\odot}$
Final black hole spin	$0.67^{+0.05}_{-0.07}$
Luminosity distance	$410^{+160}_{-180} \text{ Mpc}$
Source redshift, z	$0.09^{+0.03}_{-0.04}$

Phys. Rev. Lett. 116, 061102 (2016)

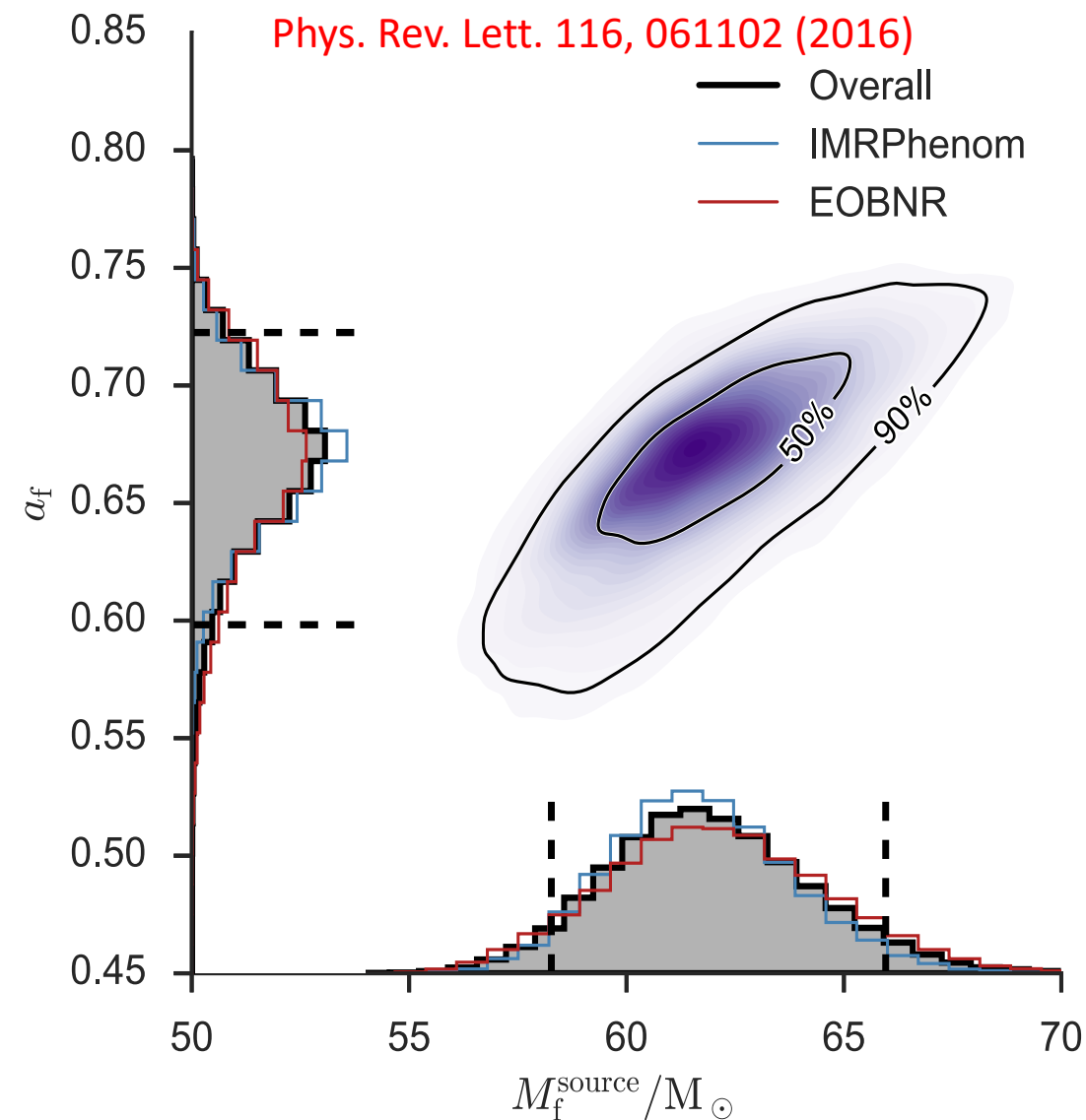

Distance ~ 410 Mpc: The merger happened 1.3 billion years ago...

LIGO: The First Run

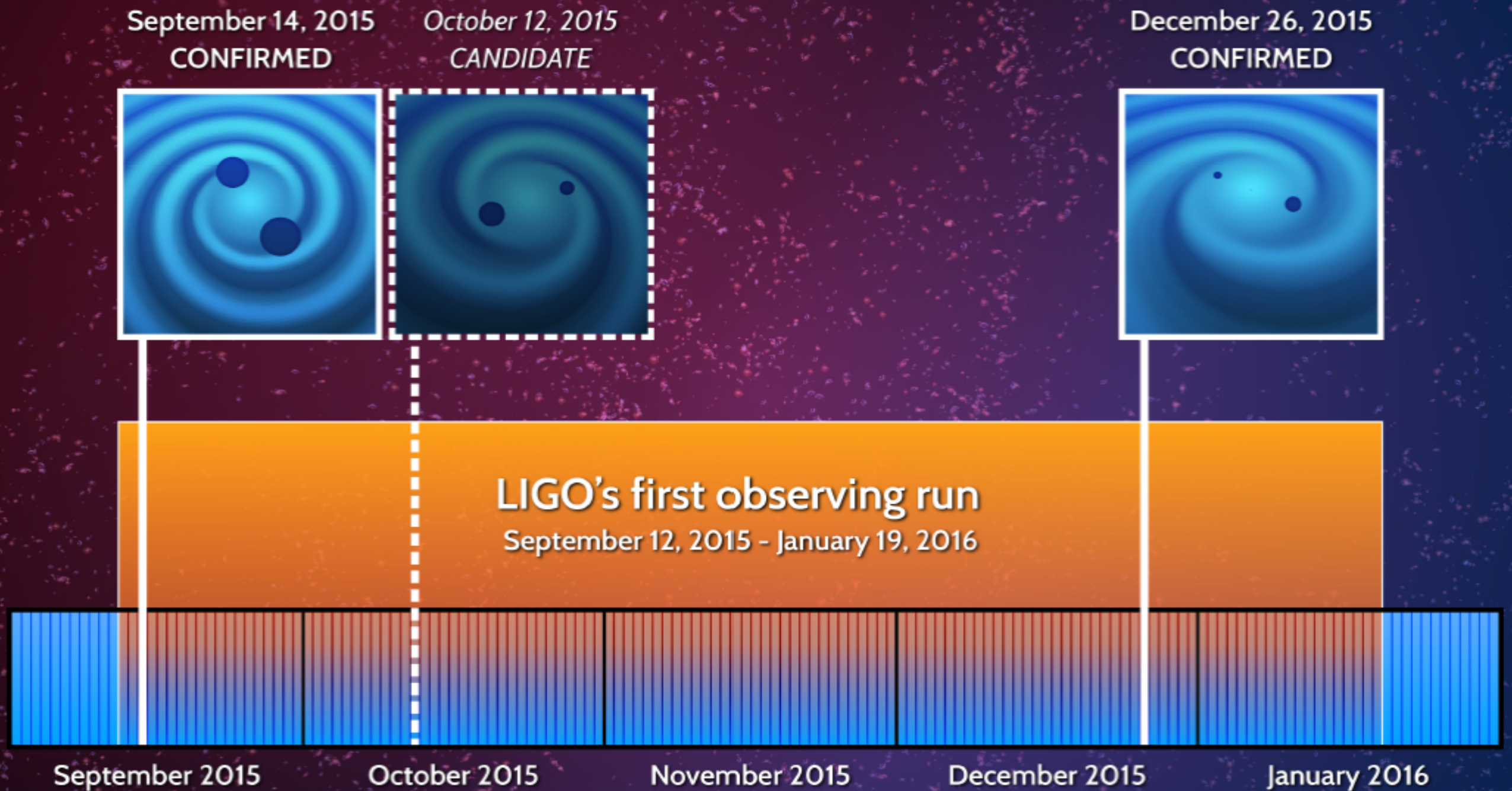

- Nobel Prize 2017 to Rainer Weiss, Barry Barish and Kip Thorne for decisive contributions to the LIGO detector and the observation of gravitational waves

First LIGO Observations in Perspective

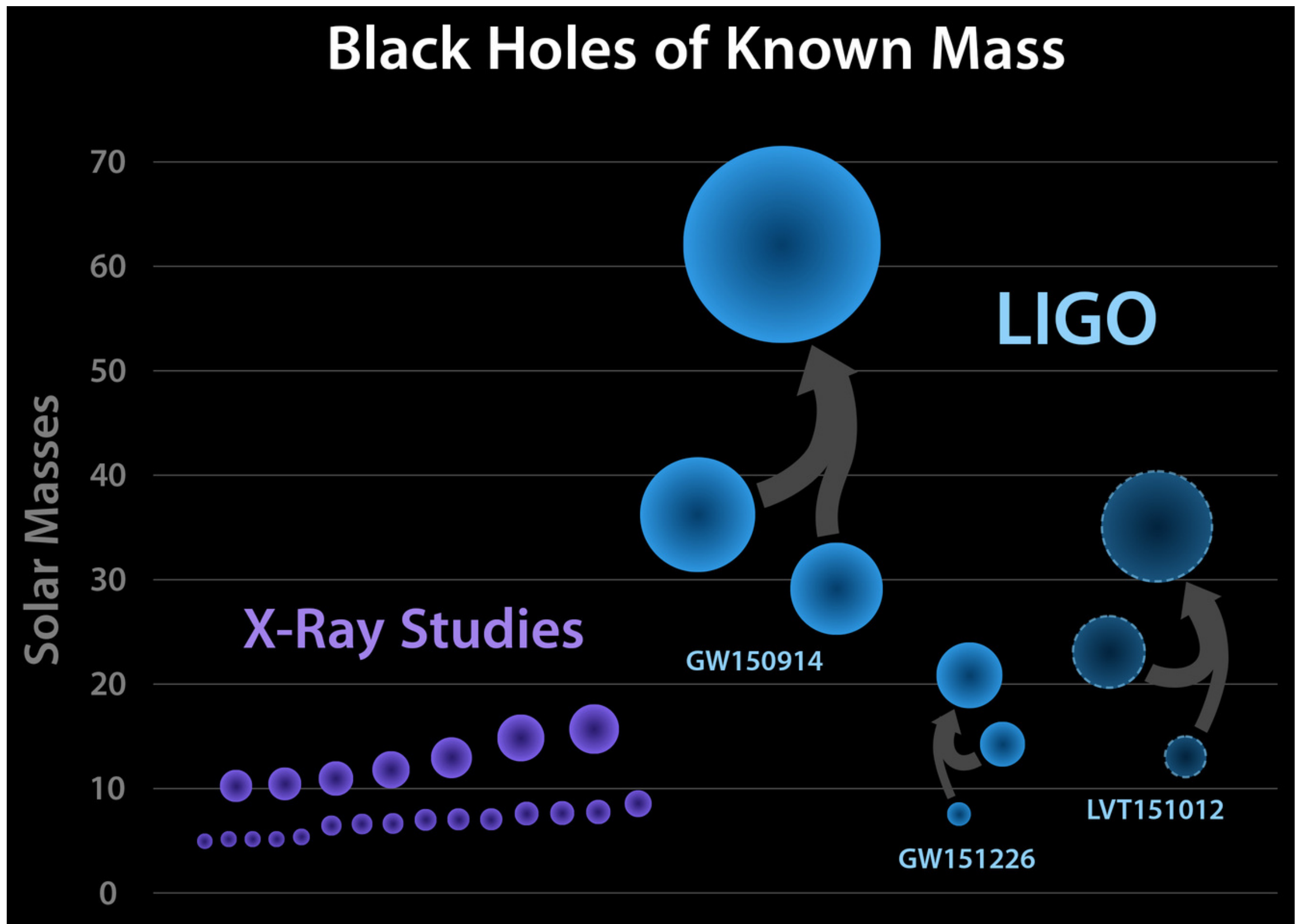

Gravitational Wave Observatories

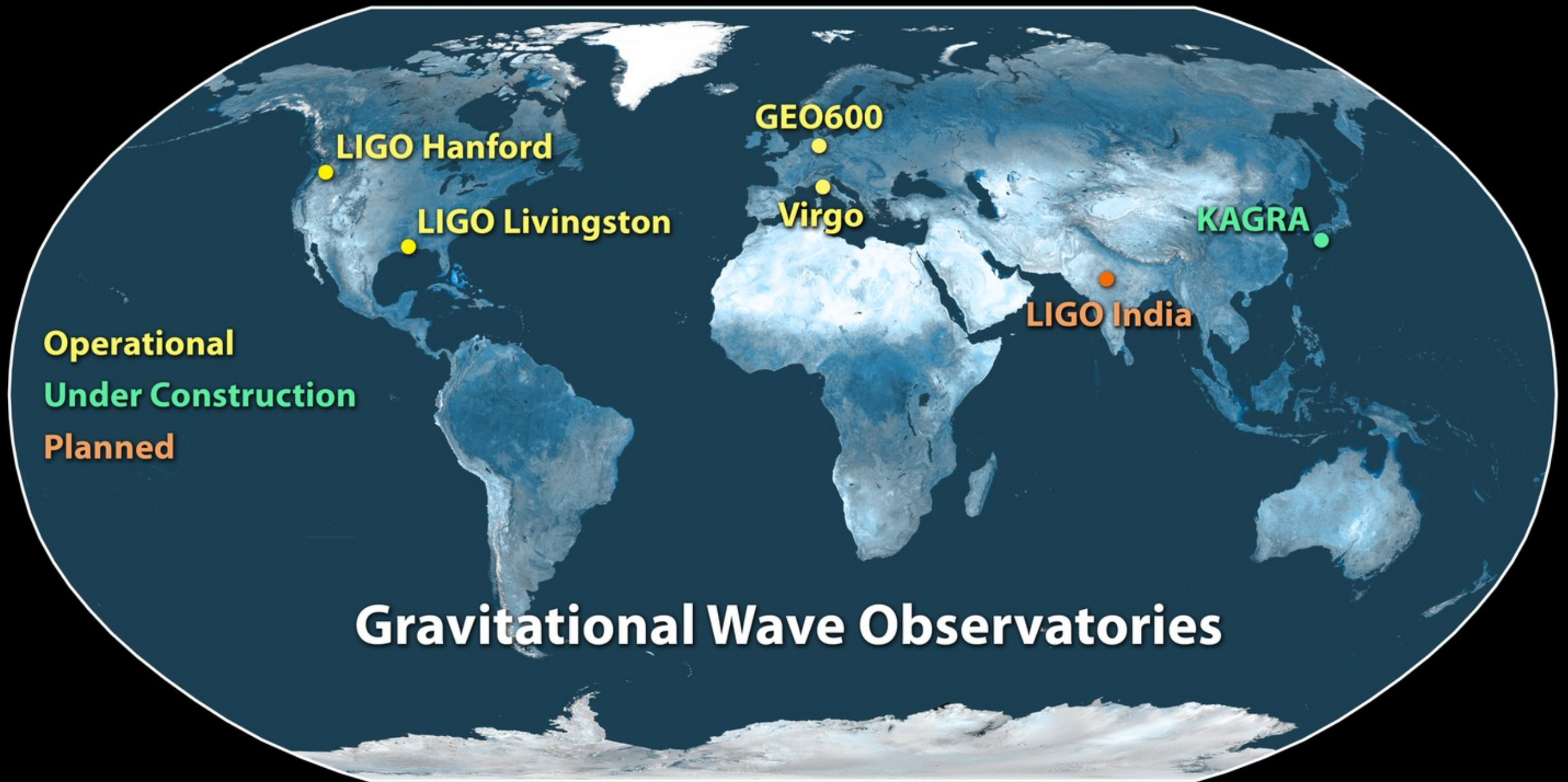

VIRGO: A Third Eye

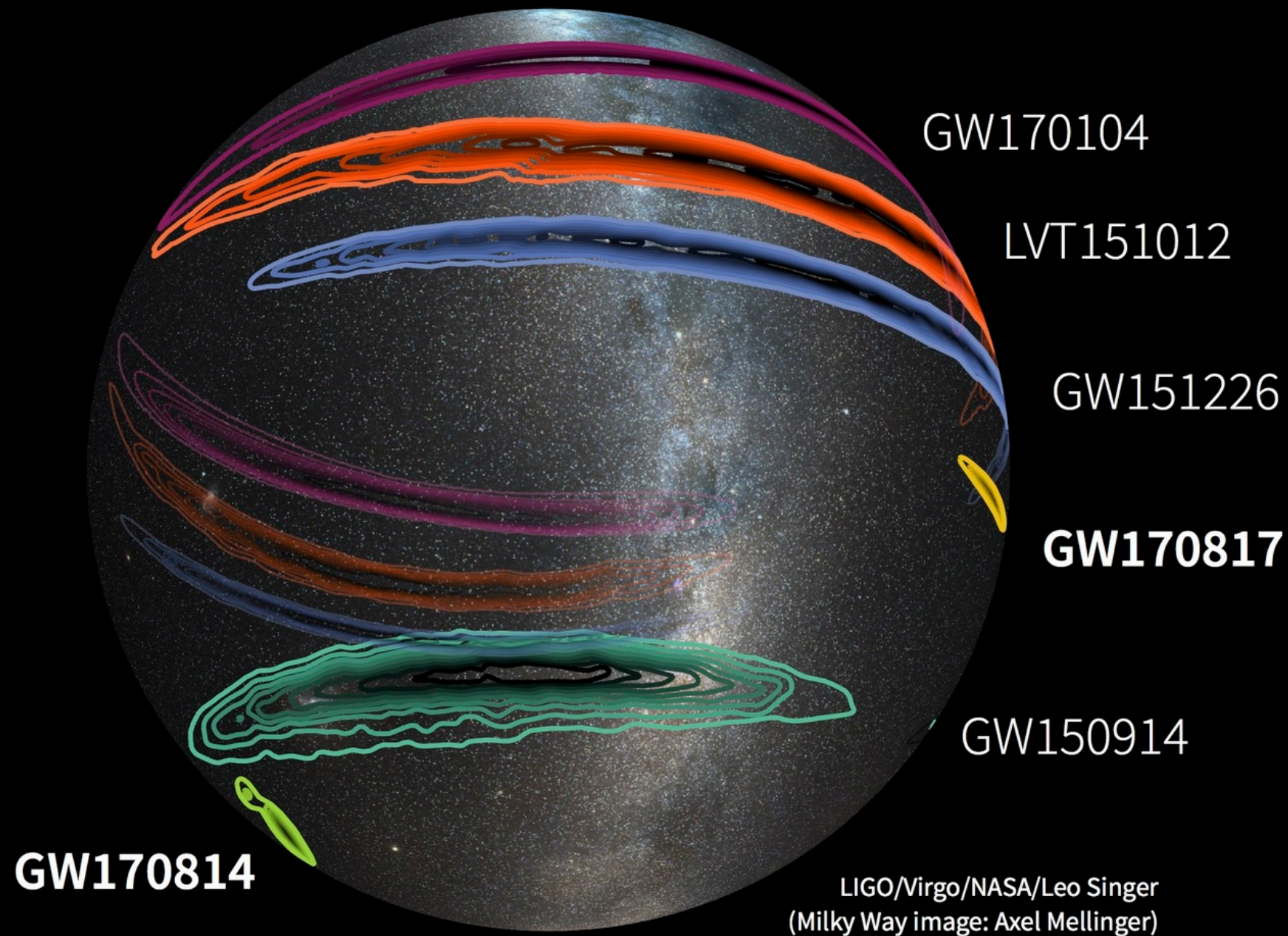

- Since Mid-2017: VIRGO has joined LIGO in GW observations: Dramatically improved location accuracy

Gravitational Waves and Gamma Rays

- A spectacular observation in August 2017: Gravitational waves together with gamma rays: 2 s long Gamma Ray Burst observed 1.7 s after gravitational wave signal
 - GRB observation by satellites, among them Fermi and Integral

Located in Galaxy NGC4993
(40 Mpc from earth)

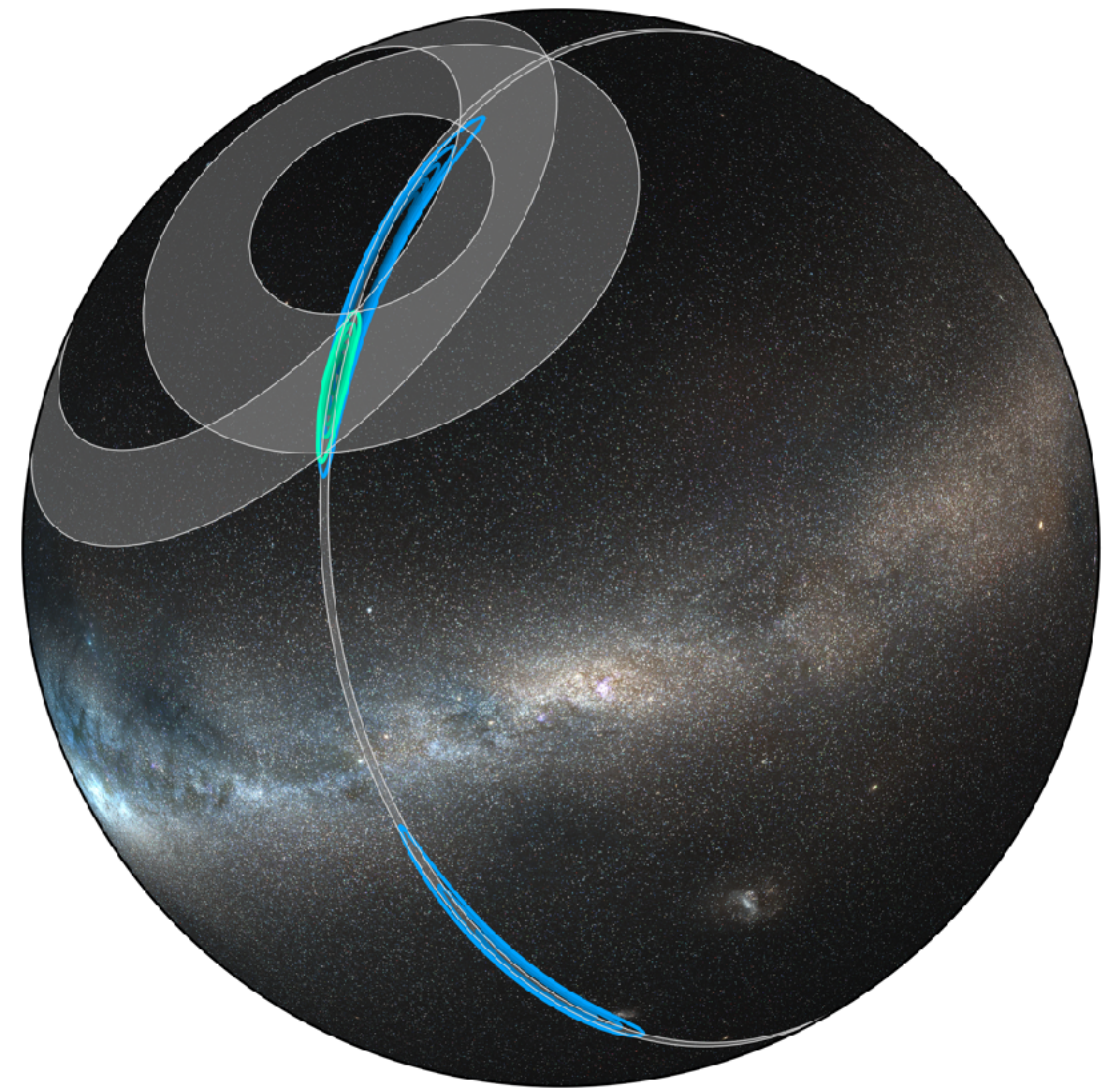
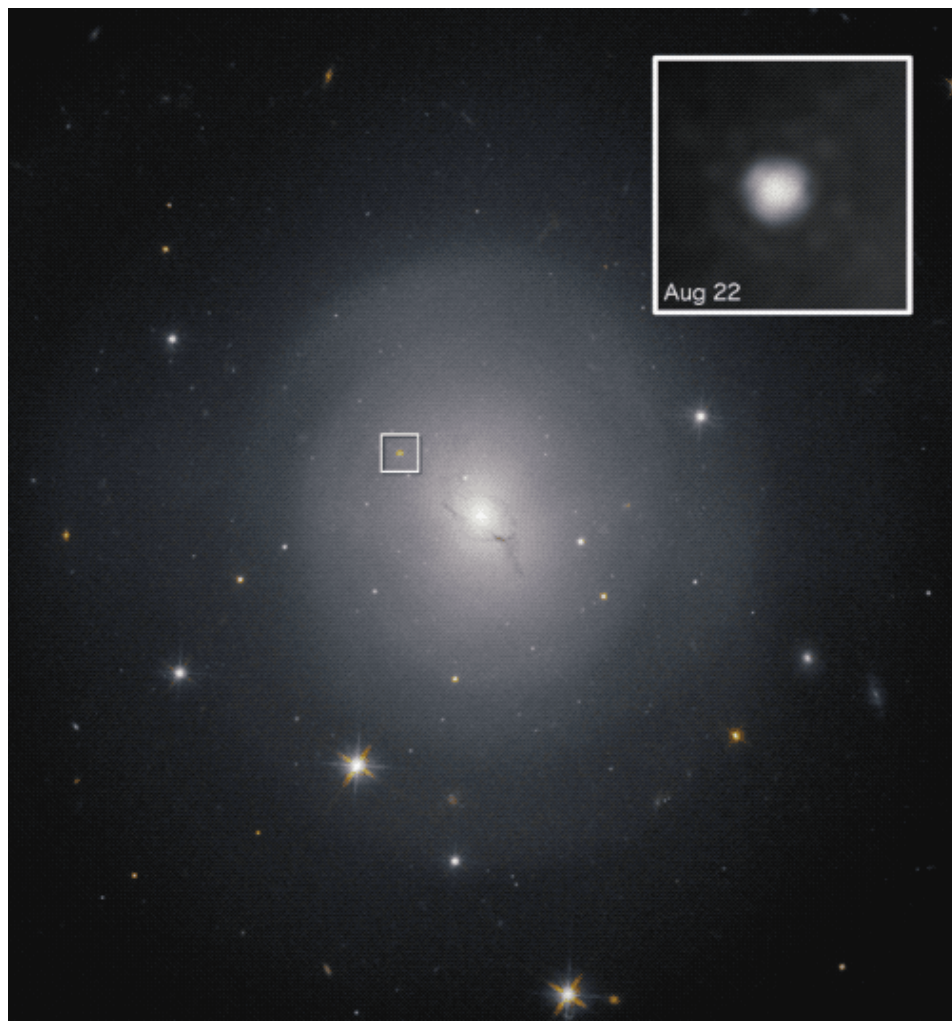

Credit: LIGO/Virgo/NASA/Leo Singer (Milky Way image: Axel Mellinger)

A Binary Neutron Star Merger

Stellar lives, brilliant death, and black hole birth

The August gravitational wave event from merging neutron stars, and associated panchromatic transient, were billions of years in the making. This figure follows a plausible formation channel, starting with two massive stars orbiting each other and ending with a black hole and the creation of many Earth-mass amounts of precious metals. The light comes from both the fast-expanding kilonova and the cocoon/jet breakout observed $\sim 30^\circ$ off axis.

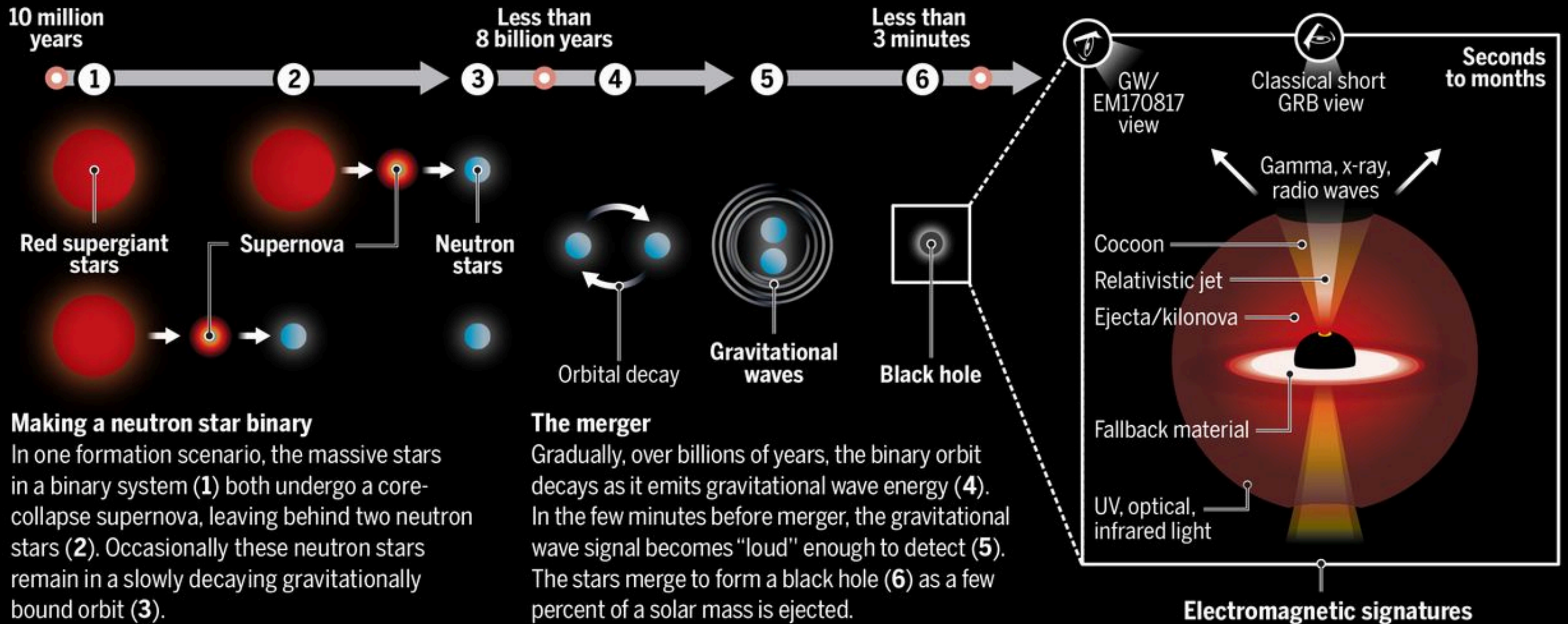

- ... and the beginning of multi-messenger astronomy with gravitational waves!

LIGO - Virgo Observations in Perspective

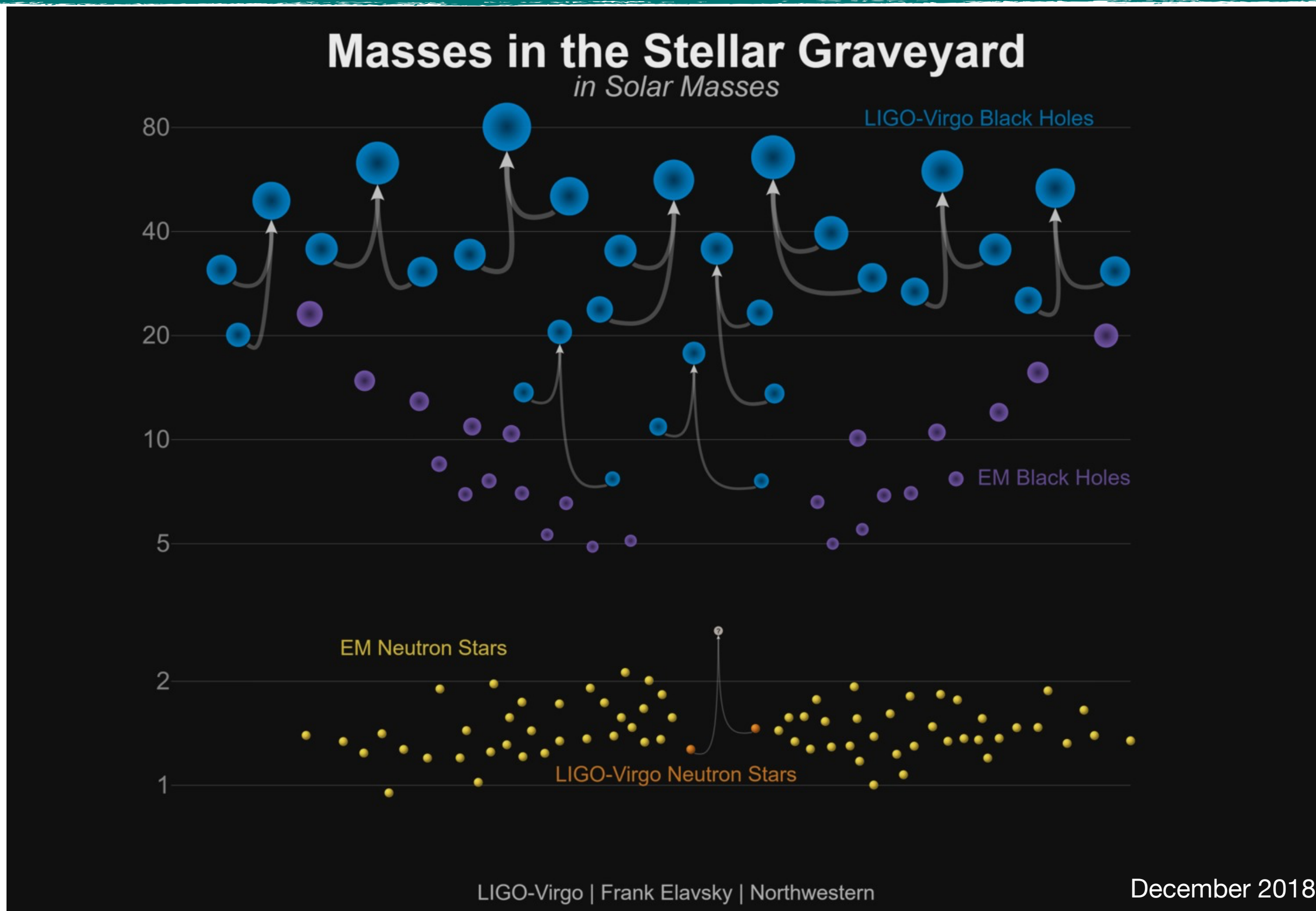

Future Projects in GW Astronomy

- Possible future Detector on earth: Einstein Telescope

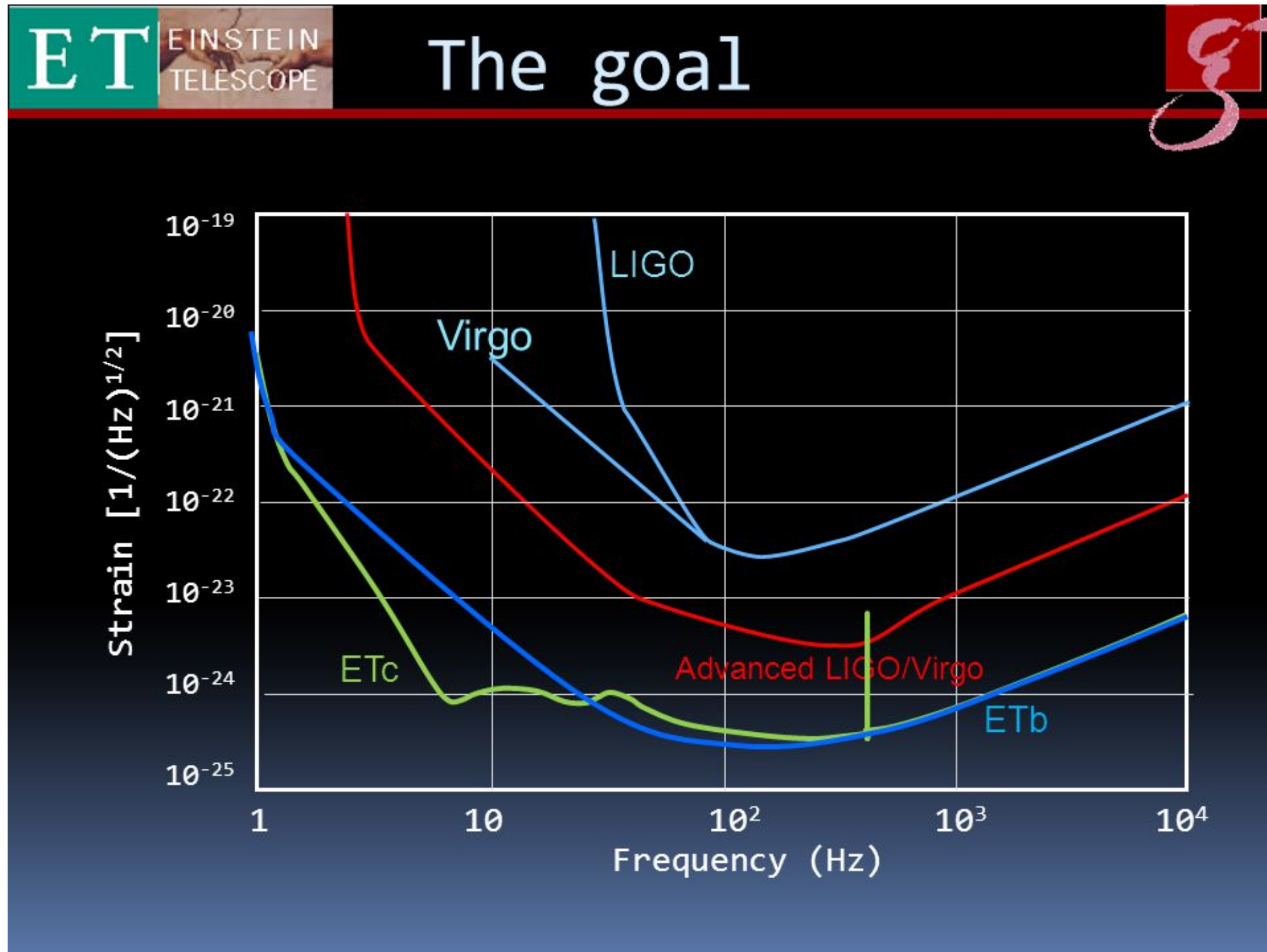

Future Projects in GW Astronomy

- future Projects in Space: eLISA

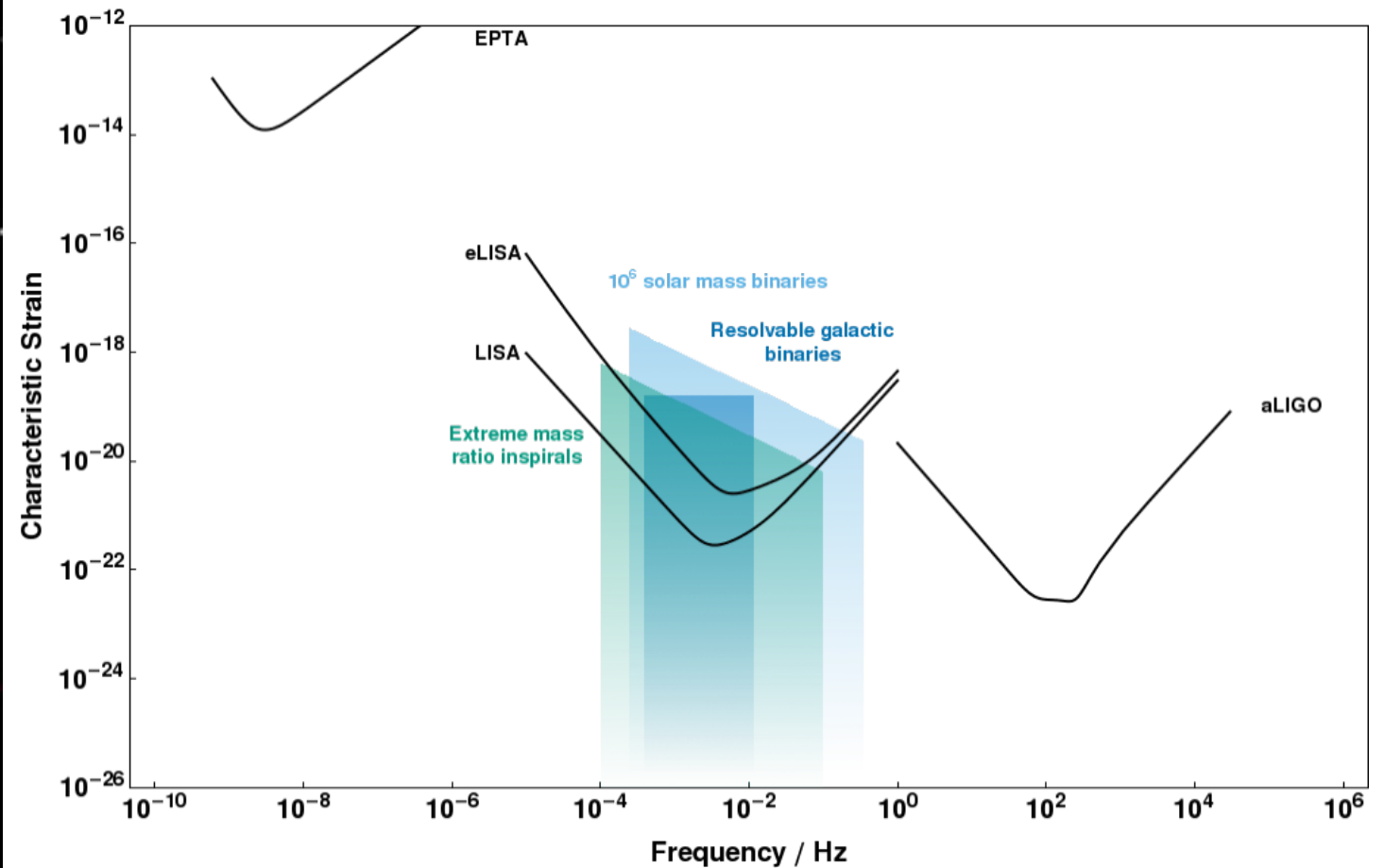

arm lengths: 5 million km (LISA)
1 million km (eLISA)

- LISA: joined NASA & ESA project
- 2011: NASA quits participation
- eLISA: ESA revised mission concept
- 2015: launch of LISA pathfinder
- 2034: tentative launch eLISA

Summary

- First successful direct observation of gravitational waves
- First direct observation of stellar binary black hole merger
- First direct observation of massive black holes with $M > 25 \times M_{\text{sun}}$

- Provides: important tests of general relativity
- Start of observational astronomy/astrophysics using gravitational waves as messengers

- First observation of a binary neutron star merger in both gravitational waves and gamma rays (GRB) - Beginning of multi-messenger astronomy

- A rapidly evolving field - new discoveries expected, new projects on the horizon

Next Lecture: 22.07., “Physics with Flavor: Top and Bottom”, F. Simon

Lecture Overview

29.04.	Introduction & Recap: Particle Physics & Experiments	<i>F. Simon</i>
06.05.	Dark Matter axions and ALPs: Where do they come from?	<i>B. Majorovits</i>
13.05.	Axions and ALPs detection	<i>B. Majorovits</i>
20.05.	Dark Matter WIMPs - origin and searches	<i>B. Majorovits</i>
27.05.	Precision Tests of the Standard Model	<i>F. Simon</i>
03.06.	Neutrinos: Freeze out, cosmological implications, structure formation	<i>B. Majorovits</i>
	Pentecost	
17.06.	Natural Neutrino Sources: What can we learn from them?	<i>B. Majorovits</i>
24.06.	Neutrino Oscillations with Manmade Sources	<i>F. Simon</i>
01.07.	Precision Experiments with Low-Energy Accelerators	<i>F. Simon</i>
08.07.	Neutrinoless Double Beta Decay	<i>B. Majorovits</i>
15.07.	Gravitational Waves	<i>F. Simon</i>
22.07.	Physics with Flavor: Top and Bottom	<i>F. Simon</i>